



Characteristics of materials structure by the X-ray diffraction

XI

The first order stresses



Stress and strain

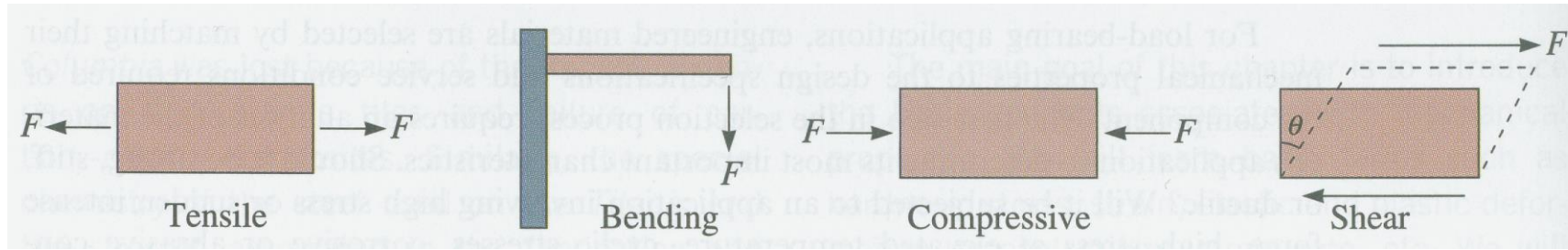

Tensile, bending, compressive and shear loads

Donald R. Askeland, Pradeep P. Phulé „The science and engineering of materials”, Thomson 2006.



Stress and strain

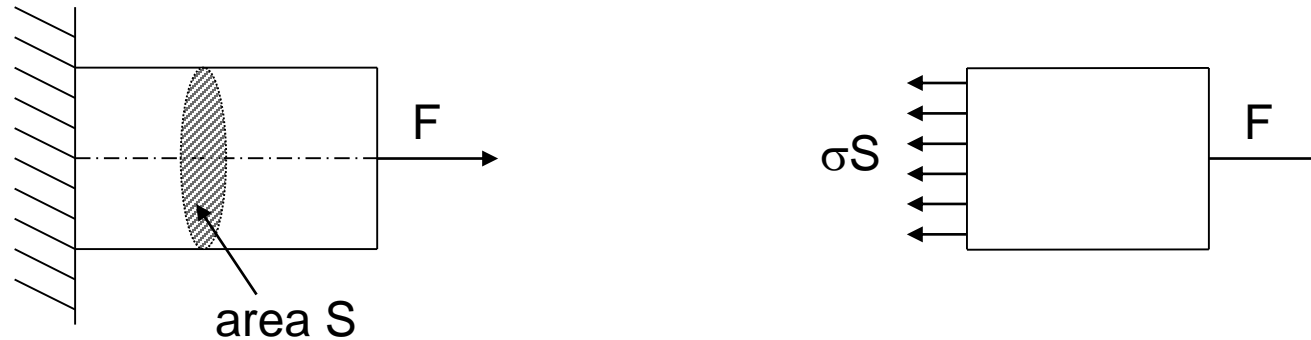

$$F = \sigma S \Rightarrow \sigma = \frac{F}{S}$$

where: σ - stress

σS – internal resistance force

F – axial force

$$\text{Engineering Stress} = \sigma = F/S \text{ [MPa]}$$

Project WND-POWR.03.02.00-00-1043/16

International interdisciplinary PhD Studies in Materials Science with English as the language of instruction

Project co-financed by the European Union within the European Social Funds

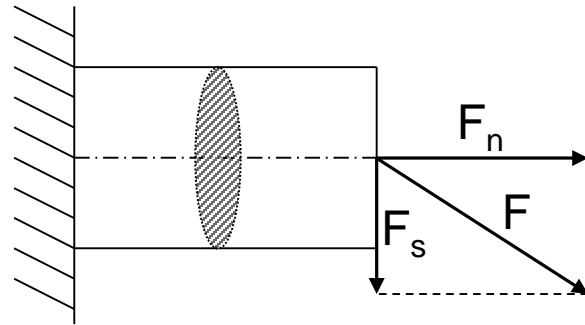

Tensile stress

$$\sigma = F_n / S$$

Tangential (shear) stress

$$\tau = F_s / S$$

The value of stress is always equal to the force divided by the area.

$$1 \text{ Pa} = 1,019716 \cdot 10^{-5} \text{ at}$$

$$= 1,019716 \cdot 10^{-5} \text{ kG/cm}^2$$

$$= 1,450377 \cdot 10^{-4} \text{ psi}$$

$$= 10^{-5} \text{ bar}$$

$$= 0,98692326671 \cdot 10^{-5} \text{ atm}$$

$$= 0,0075006167382112 \text{ mmHg}$$

$$= 0,1019716212977928 \text{ mmH}_2\text{O}$$

$$= 10 \text{ b}$$

Units : (N·m⁻²) (MN·m⁻²) lub MPa



What causes tensile stress?

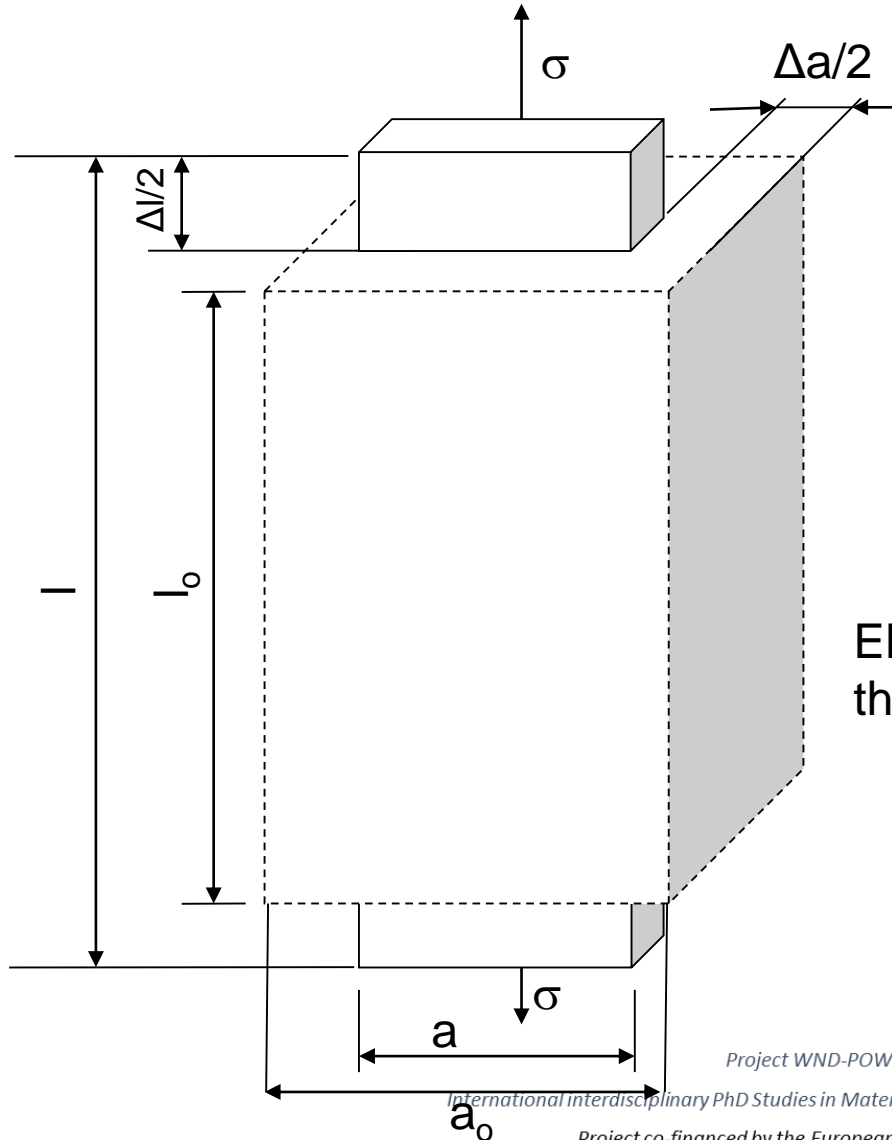

σ causes:

linear strain

ε_n – nominal linear strain

$$\varepsilon_n = \frac{\Delta l}{l_0} = \frac{l - l_0}{l_0}$$

Elongation changes the transverse cross-section, the measure of the strain is:

ε_p – transverse strain

$$\varepsilon_p = -\frac{\Delta a}{a_0} = \frac{a - a_0}{a_0}$$



What is the shear stress??

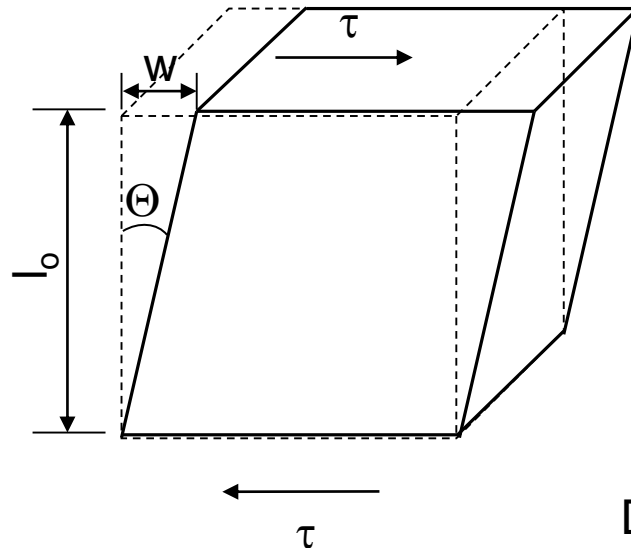

Non-dilatational strain

$$\gamma = \frac{w}{l_0} = \text{tg } \Theta$$

Defined strains

ε_n – *nominal linear strain (+)*

ε_p – *transverse strain (-)*

γ - *non-dilatational strain*



Poisson's coefficient:

$$\nu = -\frac{\varepsilon_p}{\varepsilon_n}$$

In case of large deformations

n this case, we are talking about real strain:

$$\varepsilon_r = \int_{l_0}^l \frac{dl}{l} = \ln \frac{l}{l_0}$$

where: l_0 - length before deformation, l – length after deformation



Young's modulus

According to Hooke's law (for small deformations), the deformation is proportional to the compression or tensile force applied:

$$\sigma = E\varepsilon$$

gdzie E – Youngs modulus (współczynnik sprężystości wzdłużnej) [GPa]

The elastic deformation is the result of the increased distance between the atoms:



Stress-free



Stress expressed by the change of distance between atoms



Change in shape due to application of tensile force



First, second and third order stresses, XRD, TEM and SEM



Definition of different types of stresses at various spatial scales

Scale of the first order stresses

(the macrostress σ_{ij}^M is the mean value over V_A volume)

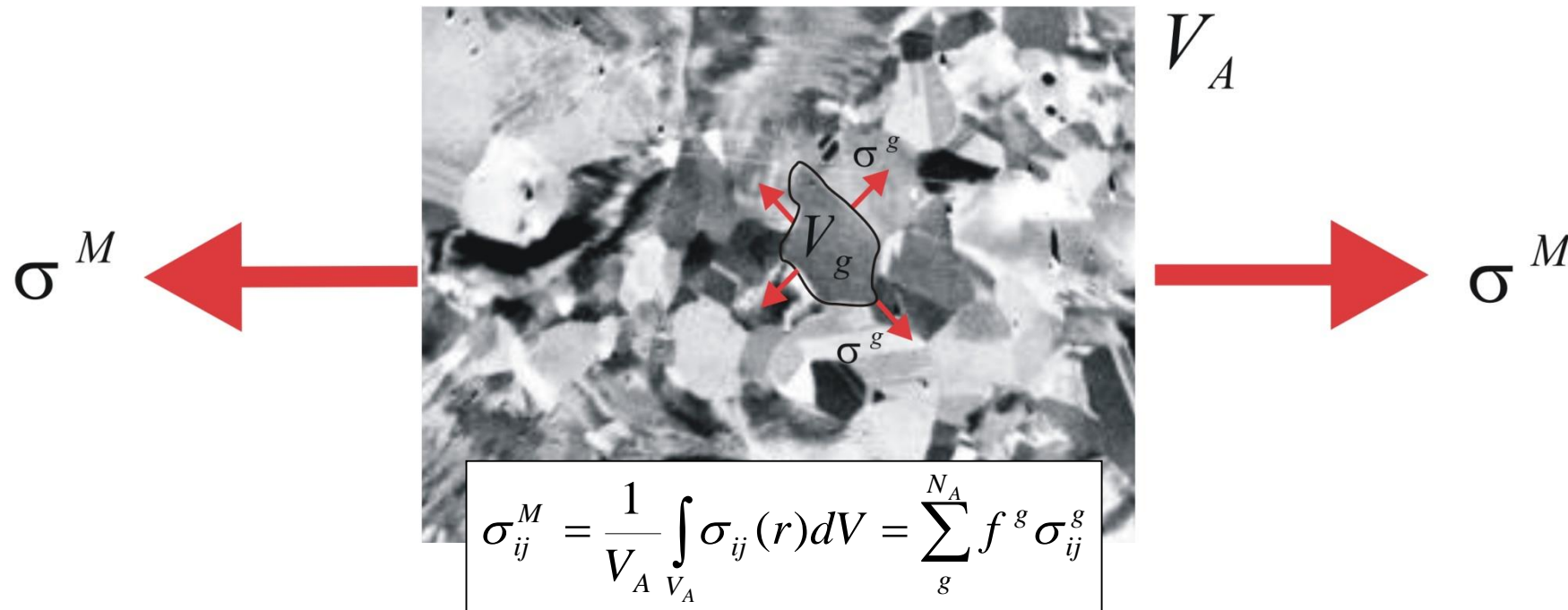

where: N_A - total number of grains $\sigma_{ij}(r)$ - local stress at r position
 $f^g = \frac{V_g}{V_A}$ and σ_{ij}^g - the volume fraction and the mean stress for grain g having volume V_g



Scale of the second order stresses

(σ_{ij}^g is the mean stress for the volume V_g of the g -th grain)

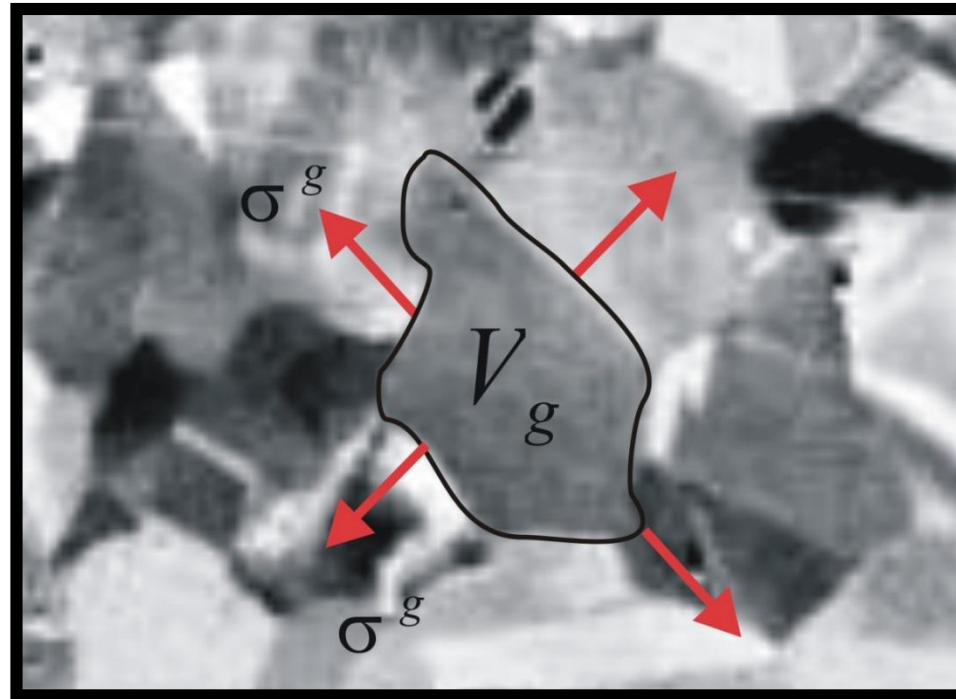

$$\sigma_{ij}^{IIg} = \sigma_{ij}^g - \sigma_{ij}^I \quad \text{where} \quad \sigma_{ij}^I = \sigma_{ij}^M \quad \text{for single phase material}$$



Scale of the third order stresses

(the local stress at r position is indicated)

$$\sigma_{ij}^{III}(r) = \sigma_{ij}(r) - \sigma_{ij}^g$$

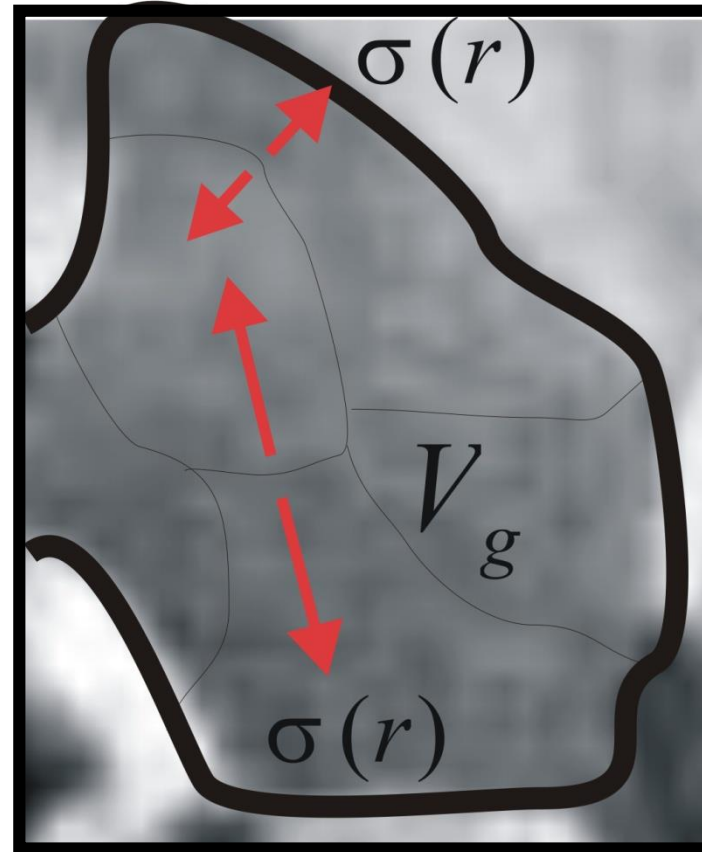

First order stresses

XRD

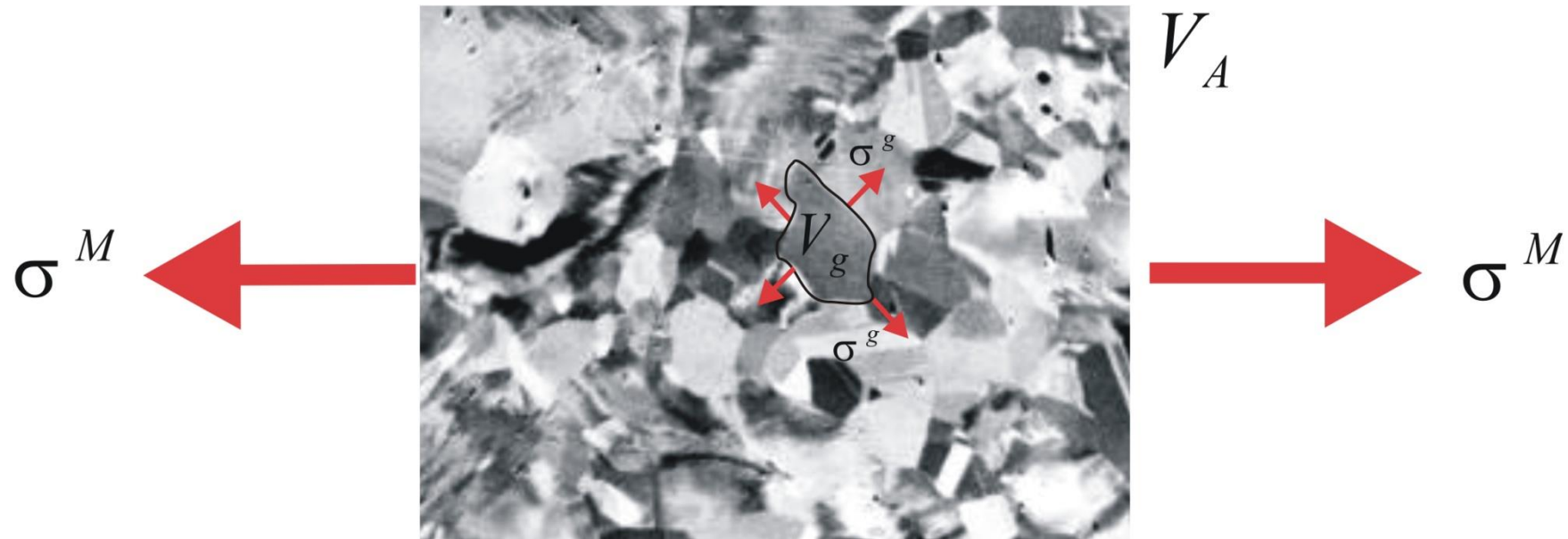



Strain Measurement

To perform strain measurements the specimen is placed in the X-ray diffractometer, and it is exposed to an X-ray beam that interacts with the crystal lattice to cause diffraction patterns. By scanning through an arc of radius about the specimen the diffraction peaks can be located and the necessary calculations made.

There is a clear relationship between the diffraction pattern that is observed when X-rays are diffracted through crystal lattices and the distance between atomic planes (the inter-planar spacing) within the material. **By altering the inter-planar spacing different diffraction patterns will be obtained.** Changing the wavelength of the X-ray beam will also result in a different diffraction pattern. The inter-planar spacing of a material that is free from strain will produce a characteristic diffraction pattern for that material. When a material is strained, elongations and contractions are produced within the crystal lattice, which change the inter-planar spacing of the $\{hkl\}$ lattice planes. **This induced change in d will cause a shift in the diffraction pattern. By precise measurement of this shift, the change in the inter-planar spacing can be evaluated and thus the strain within the material deduced.**

M.E. Fitzpatrick, A.T. Fry, P. Holdway, F.A. Kandil, J. Shackleton and L. Suominen: Determination of Residual Stresses by X-ray Diffraction.

Project WND-POWR.03.02.00-00-1043/16

International interdisciplinary PhD Studies in Materials Science with English as the language of instruction

Project co-financed by the European Union within the European Social Funds

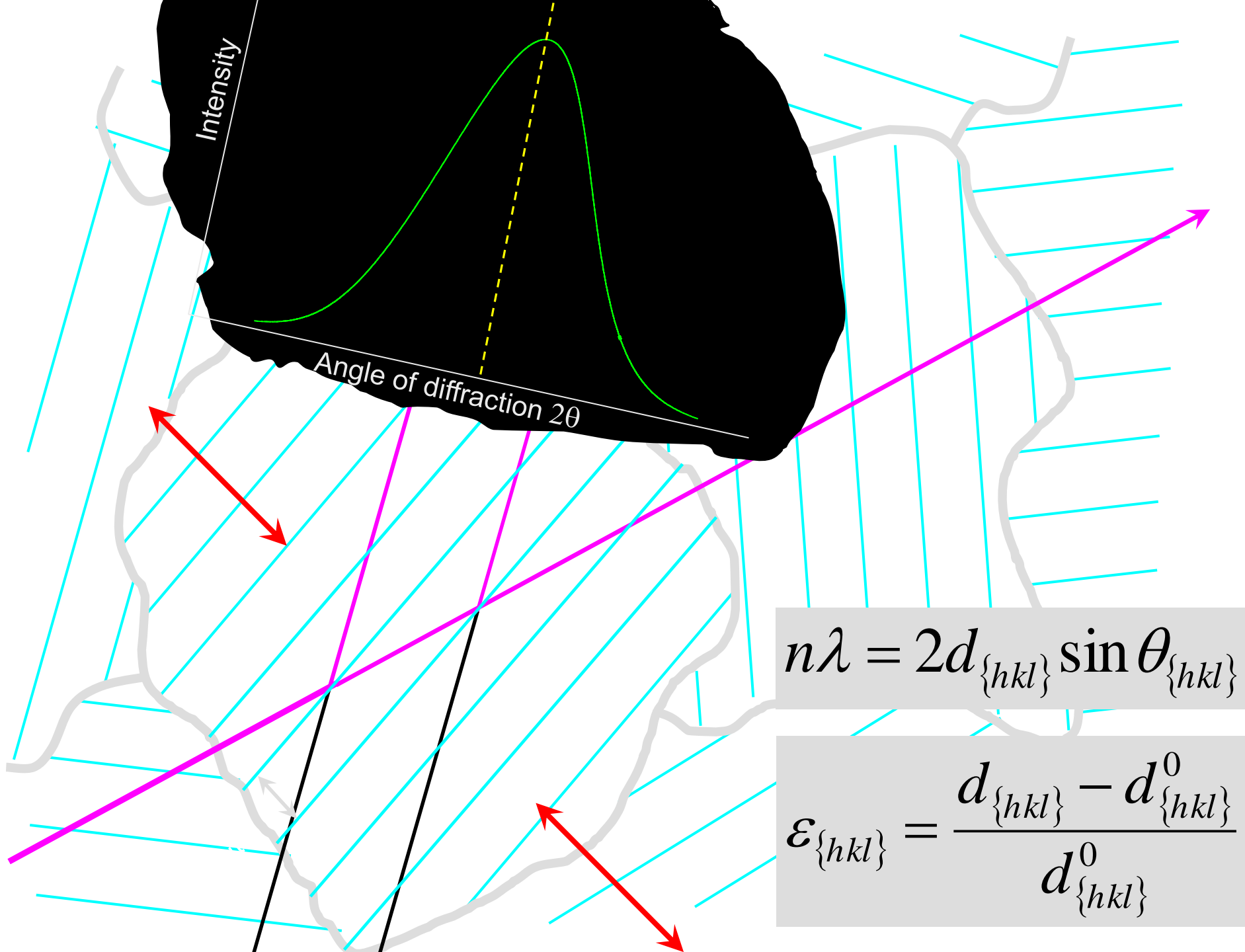

$$n\lambda = 2d_{\{hkl\}} \sin \theta_{\{hkl\}}$$

$$\varepsilon_{\{hkl\}} = \frac{d_{\{hkl\}} - d_{\{hkl\}}^0}{d_{\{hkl\}}^0}$$



Strain Measurement

The strain which is measured is defined as $\epsilon_{\phi,\psi}$

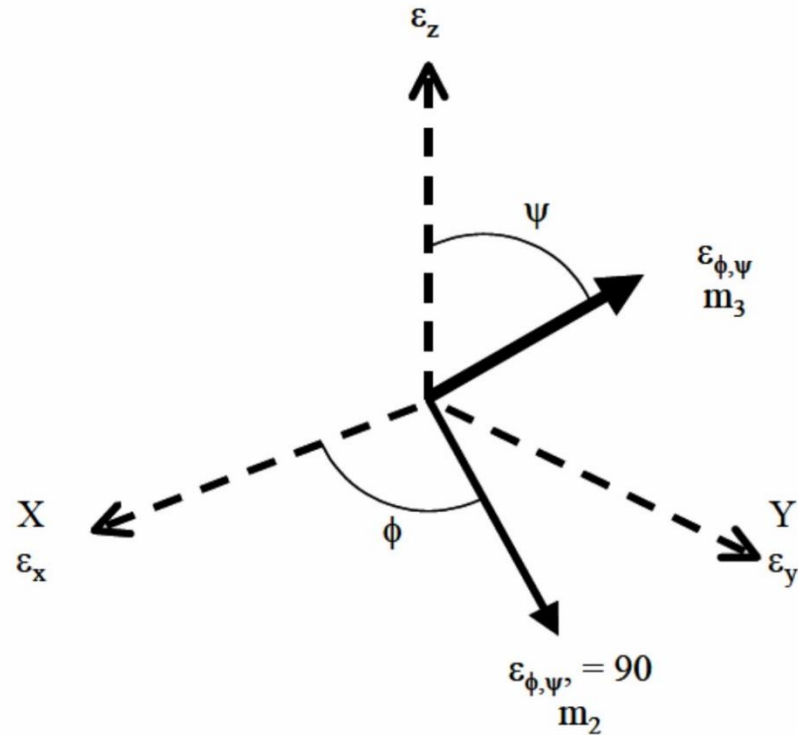

Principal Axes of Strain

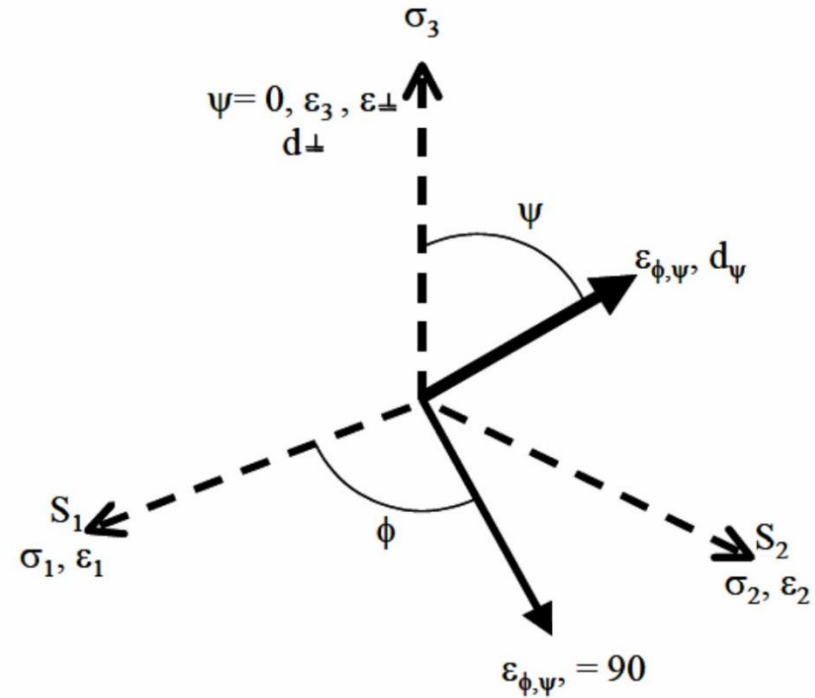

Principal Stresses, corresponding strains and stress direction of interest

M.E. Fitzpatrick, A.T. Fry, P. Holdway, F.A. Kandil, J. Shackleton and L. Suominen: Determination of Residual Stresses by X-ray Diffraction.



Let us assume that because the measurement is made within the surface, that $\sigma_3 = 0$. The strain ε_z however will not be equal to zero. The strain ε_z can be measured experimental **by measuring the peak position 2θ , and solving equation $n\lambda = 2d'\sin\theta$ for a value of d_n** . If we know the unstrained inter-planar spacing do then:

$$\varepsilon_z = \frac{d_n - d_0}{d_0}$$

The strain within the surface of the material can be measured by comparing the unstressed lattice inter-planar spacing with the strained inter-planar spacing.

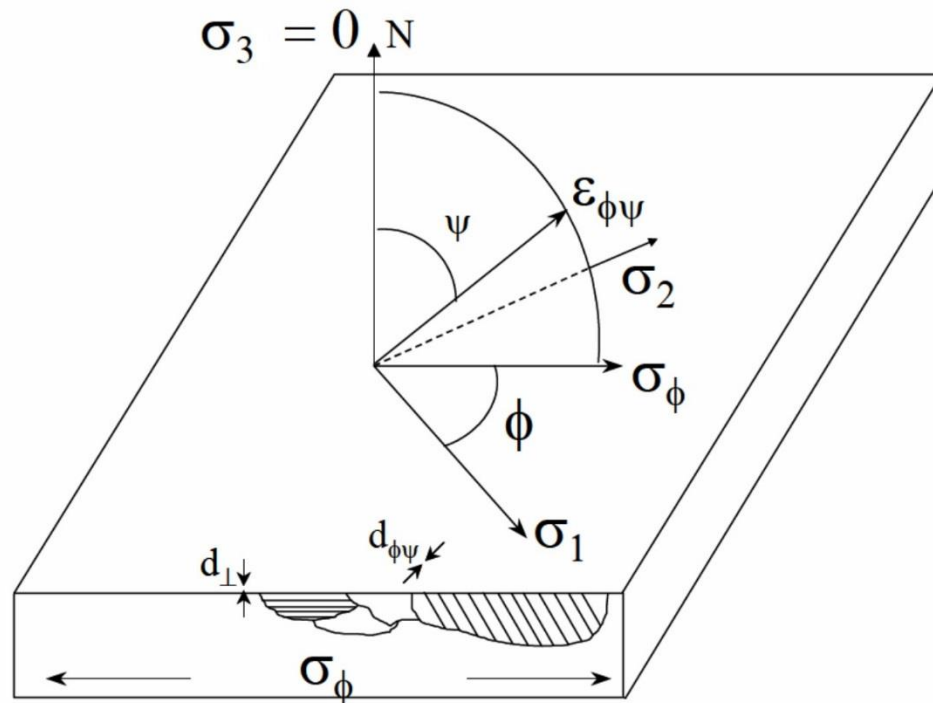

By altering the tilt of the specimen within the diffractometer, measurements of planes at an angle ψ can be made and thus the strains along that direction can be calculated using

$$\varepsilon_\psi = \frac{d_{\phi\psi} - d_0}{d_0}$$

Schematic showing diffraction planes parallel to the surface and at an angle $\phi\psi$. Note σ_1 and σ_2 both lie in the plane of the specimen surface.

M.E. Fitzpatrick, A.T. Fry, P. Holdway, F.A. Kandil, J. Shackleton and L. Suominen: Determination of Residual Stresses by X-ray Diffraction.



$\text{Sin}^2 \psi$ method

By altering the tilt of the specimen within the diffractometer, measurements of planes at an angle ψ can be made and thus the strains along that direction can be calculated using

$$\varepsilon_{\psi} = \frac{d_{\phi\psi} - d_0}{d_0}$$

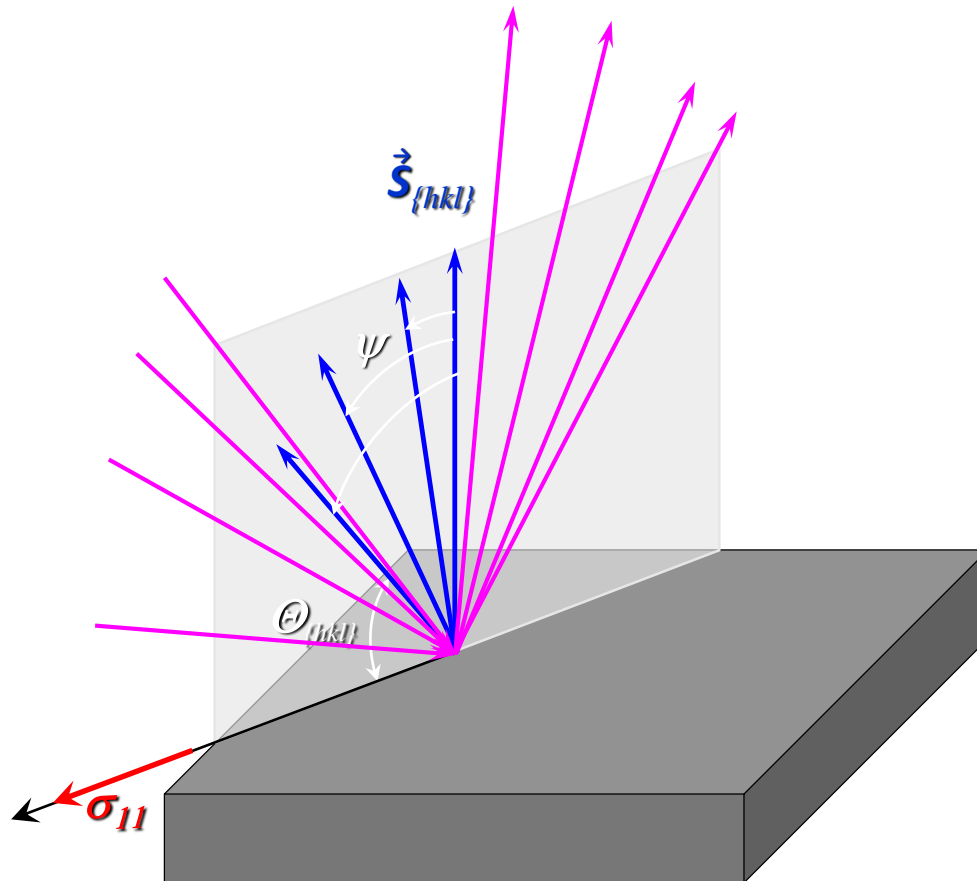



Stress Determination

Whilst it is very useful to know the strains within the material, it is more useful to know the engineering stresses that are linked to these strains. From Hooke's law we know that

$$\sigma_y = E \varepsilon_y$$

Tensile force producing a strain in the X-direction will produce not only a linear strain in that direction but also strains in the transverse directions. Assuming a state of plane stress exists, i.e. $\sigma_z = 0$, and that the stresses are biaxial, then the ratio of the transverse to longitudinal strains is Poisson's ratio, ν ;

$$\varepsilon_x = \varepsilon_y = -\nu \varepsilon_z = \frac{-\nu \sigma_y}{E}$$

M.E. Fitzpatrick, A.T. Fry, P. Holdway, F.A. Kandil, J. Shackleton and L. Suominen: Determination of Residual Stresses by X-ray Diffraction.



If we assume that $\sigma_z = 0$ then:

$$\varepsilon_z = -\nu(\varepsilon_x + \varepsilon_y) = \frac{-\nu}{E}(\sigma_x + \sigma_y)$$

Thus:

$$\frac{d_n - d_0}{d_0} = -\frac{\nu}{E}(\sigma_x + \sigma_y)$$

Equation applies to a general case, where only the sum of the principal stresses can be obtained, and the precise value of d_0 is required.



Elasticity theory for an isotropic solid shows that the strain along an inclined line (m_3) is:

$$\varepsilon_{\phi\psi} = \frac{1+\nu}{E} (\sigma_1 \cos^2 \phi + \sigma_2 \sin^2 \phi) \sin^2 \psi - \frac{\nu}{E} (\sigma_1 + \sigma_2)$$

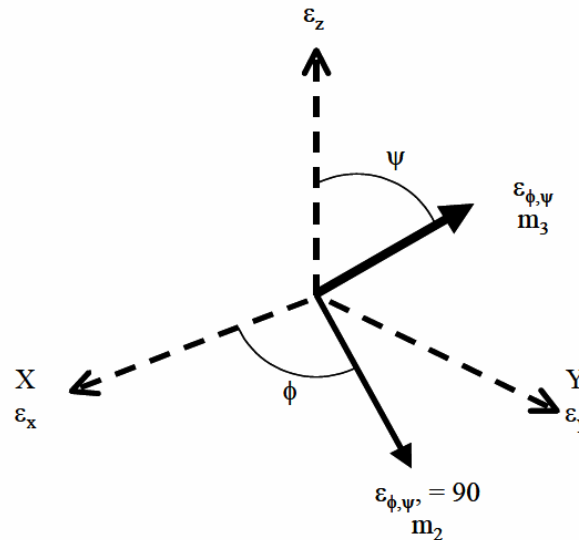

Principal Axes of Strain

M.E. Fitzpatrick, A.T. Fry, P. Holdway, F.A. Kandil, J. Shackleton and L. Suominen: Determination of Residual Stresses by X-ray Diffraction.

Project WND-POWR.03.02.00-00-1043/16

International interdisciplinary PhD Studies in Materials Science with English as the language of instruction

Project co-financed by the European Union within the European Social Funds



If we consider the strains in terms of inter-planar spacing, and use the strains to evaluate the stresses, then it can be shown that:

$$\sigma_{\phi} = \frac{E}{(1 + \nu) \sin^2 \psi} \left(\frac{d_{\psi} - d_n}{d_n} \right)$$

This equation allows us to calculate the stress in any chosen direction from the inter-planar spacings determined from two measurements, made in a plane normal to the surface and containing the direction of the stress to be measured.

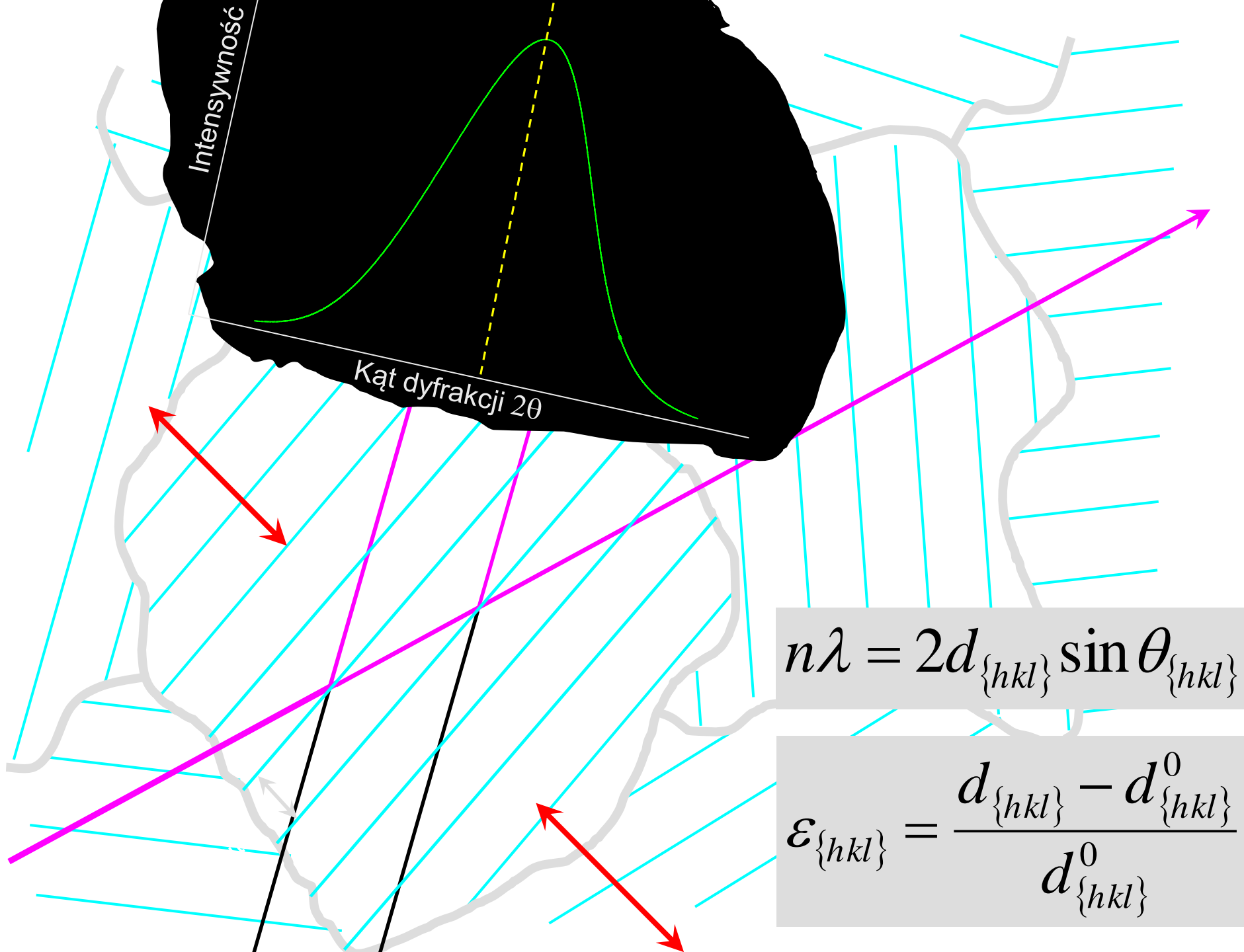



The most commonly used method for stress determination is **the $\sin^2\psi$ method**. A number of XRD measurements are made at different psi tilts. The inter-planar spacing, or 2-theta peak position, is measured and plotted as a curve similar to that shown below:

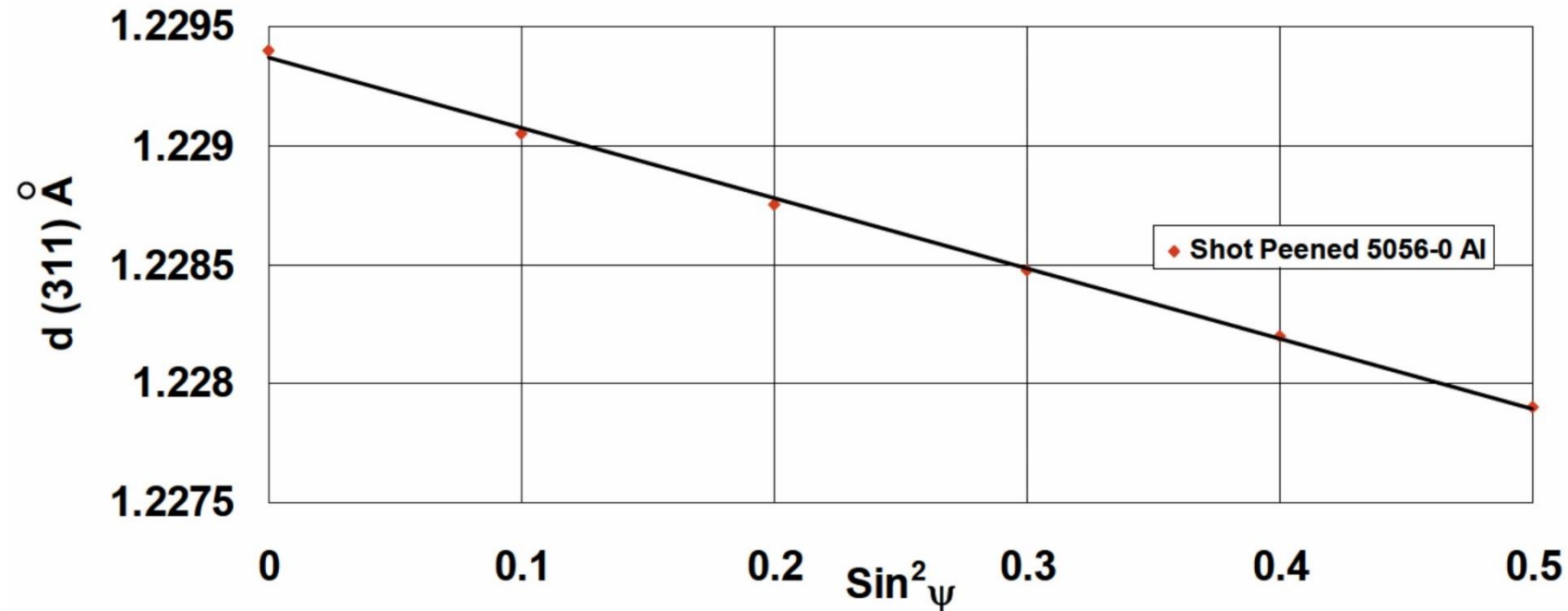

Linear dependence of $d(311)$ upon $\sin^2\psi$ for shot peened 5056-0 aluminium

Prevey, P.S. "Metals Handbook: Ninth Edition," Vol. 10, ed. K. Mills, pp 380-392, Am. Soc. for Met., Metals Park, Ohio (1986)

M.E. Fitzpatrick, A.T. Fry, P. Holdway, F.A. Kandil, J. Shackleton and L. Suominen: Determination of Residual Stresses by X-ray Diffraction.

Project WND-POWR.03.02.00-00-1043/16

International interdisciplinary PhD Studies in Materials Science with English as the language of instruction

Project co-financed by the European Union within the European Social Funds



The stress can then be calculated from such a plot by calculating the gradient of the line and with basic knowledge of the elastic properties of the material. This assumes a zero stress at $d = d_n$, where d is the intercept on the y-axis when $\sin^2\psi = 0$:

$$\sigma_{\phi} = \left(\frac{E}{1 + \nu} \right) m$$

where m is the gradient of the d vs. $\sin^2\psi$ curve.



The above equation is the basis of stress determination using X-ray diffraction.

M.E. Fitzpatrick, A.T. Fry, P. Holdway, F.A. Kandil, J. Shackleton and L. Suominen: Determination of Residual Stresses by X-ray Diffraction.



More complex solutions for stress determination using X-ray diffraction exist for non-ideal situations where, for example, ψ splitting occurs (caused by the presence of shear stresses) or there is an inhomogeneous stress state within the material.

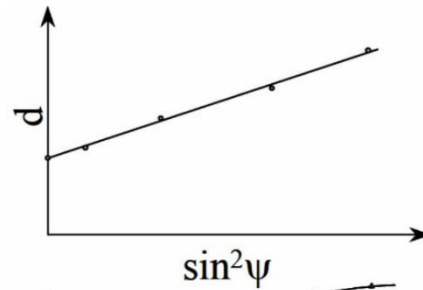

Regular d vs $\sin^2\psi$ behaviour with ϵ_{13} and ϵ_{23} being zero.

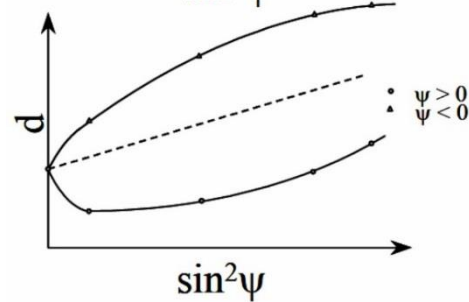

ψ -splitting - ϵ_{13} and/or ϵ_{23} are non-zero.

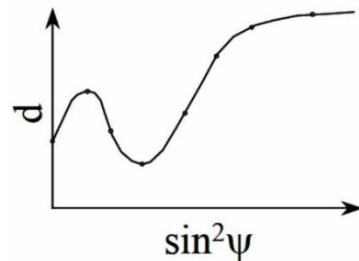

Oscillatory - indicating the presence of an inhomogeneous stress/strain state within the material usually due to Preferred orientation (texture).

M.E. Fitzpatrick, A.T. Fry, P. Holdway, F.A. Kandil, J. Shackleton and L. Suominen: Determination of Residual Stresses by X-ray Diffraction.



Depth of Penetration

Many metallic specimens strongly absorb X-rays, and because of this the intensity of the incident beam is greatly reduced in a very short distance below the surface. Consequently the majority of the diffracted beam originates from a thin surface layer, and hence the residual stress measurements correspond only to that layer of the material. This begs the question of what is the effective penetration depth of X-rays and to what depth in the material does the diffraction data truly apply? This is not a straightforward question to answer and is dependent on many factors that include the absorption coefficient of the material for a particular beam, and the beam dimensions on the specimen surface.

M.E. Fitzpatrick, A.T. Fry, P. Holdway, F.A. Kandil, J. Shackleton and L. Suominen: Determination of Residual Stresses by X-ray Diffraction.

Project WND-POWR.03.02.00-00-1043/16

International interdisciplinary PhD Studies in Materials Science with English as the language of instruction

Project co-financed by the European Union within the European Social Funds



Figures below show the penetration depths vs. $\sin^2\psi$ for materials commonly used for residual stress measurements. The difference in the effective layer thickness with ψ angles becomes of greater importance when the test specimen exhibits a steep stress gradient:

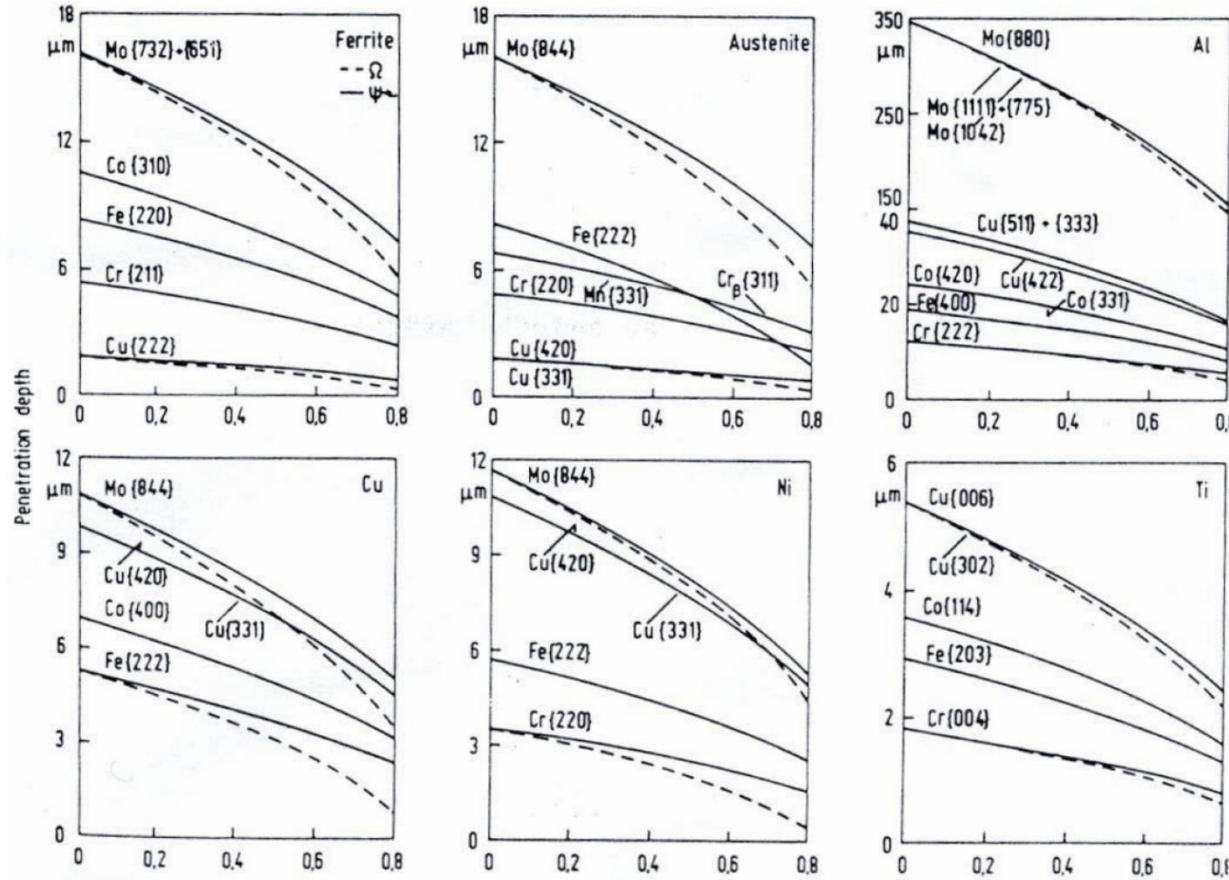

Penetration depths vs. $\sin^2\psi$ of different metals and radiations

Project WND-POWR.03.02.00-00-1043/16

International interdisciplinary PhD Studies in Materials Science with English as the language of instruction



Textured samples

Non-linearity in the $\sin^2\Psi$ relation is observed due to stress gradients or texture (Maeder, 1986). The $\sin^2\Psi$ method, or any other methods like the $\cos^2\phi$ become then non applicable as is.

An easy way to solve this problem, in the case of strong and sharp textures, is to use the "crystallite group method" (Willemse et al. 1982, Hauk et Vaessen 1985): interreticular strains are measured on several well-oriented crystalline planes (corresponding to specific orientation components) and related to the stress tensor via the single crystal elastic constants (Clemens et Bain 1992, Badawi et al. 1994, Labat et al. 2000). But this approach does not take into account the volume fraction of crystallites actually diffracting in each orientation, a quantity that can be estimated using the ODF.

From a perfectly isotropic powder of Young's modulus E and Poisson coefficient G to a perfect single crystal of elastic compliances S_{ijkl} , a broad range of mechanical behaviour can be encountered in textured samples. The way the anisotropy in elastic constants can be taken into account is still a long debate. Most of the investigations are dealing with the so-called diffraction stress factors, $F_{ij}(\phi, \psi, h)$, which take into account the deviations of the elastic constants from the single crystal case (Hauk 1997, Welzel et Mittemeijer 2003). This approach needs the ODF to be determined in order to provide a correct average of the diffraction stress factors, and is barely used in the literature. Another approach is the use of a simulation for the calculation of the macroscopic elastic tensors as they are exhibited by the oriented polycrystal. Knowing the ODF and the elastic compliance or stiffness of the single crystal, several models have been developed to calculate the real macroscopic tensor of the polycrystal. Strains can then be deduced from the measurements involving different sample orientations (in fact the texture measurements) and the stresses deduced from the simulated macroscopic constants.

M.E. Fitzpatrick, A.T. Fry, P. Holdway, F.A. Kandil, J. Shackleton and L. Suominen: Determination of Residual Stresses by X-ray Diffraction.

Project WND-POWR.03.02.00-00-1043/16

International interdisciplinary PhD Studies in Materials Science with English as the language of instruction

Project co-financed by the European Union within the European Social Funds



Novelty of the proposed method

Developed approach combines 3 advanced techniques:

- Controlled depth of X-ray penetration into the sample
- Flexible measurement grid selection for stress and texture investigation
- Modelling of texture-induced mechanical anisotropy of the material

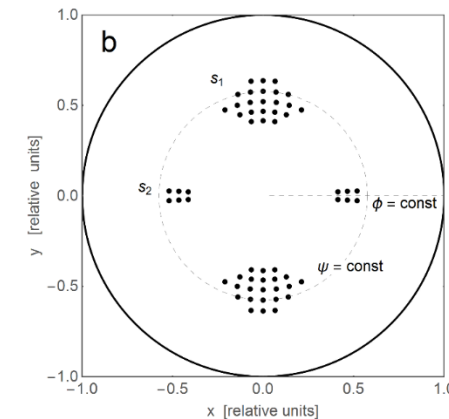
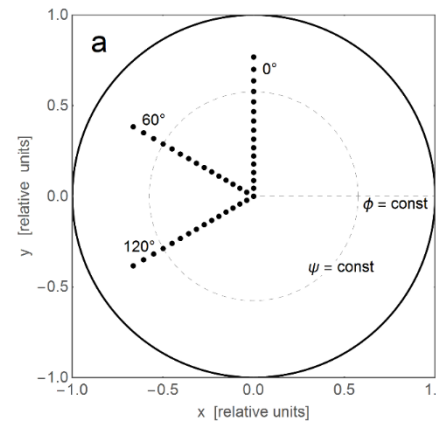
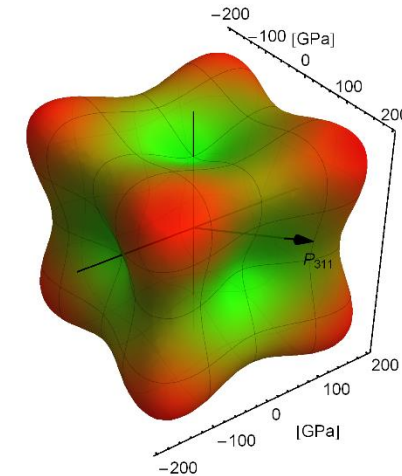
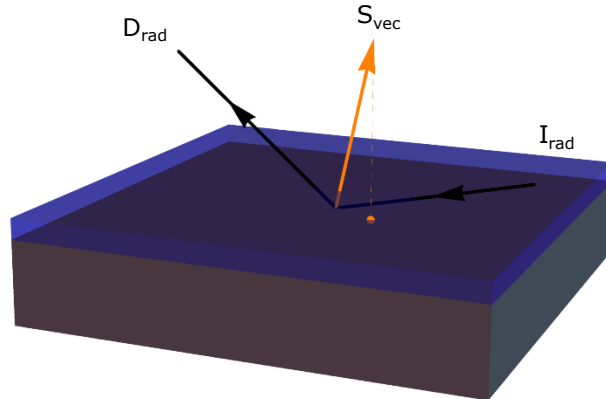



Controlling X-ray penetration depth in the stress investigation

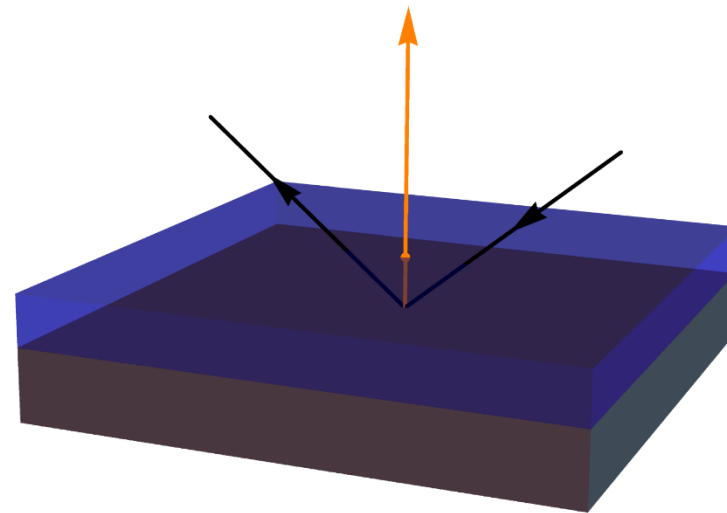



Controlling X-ray penetration depth in the stress investigation

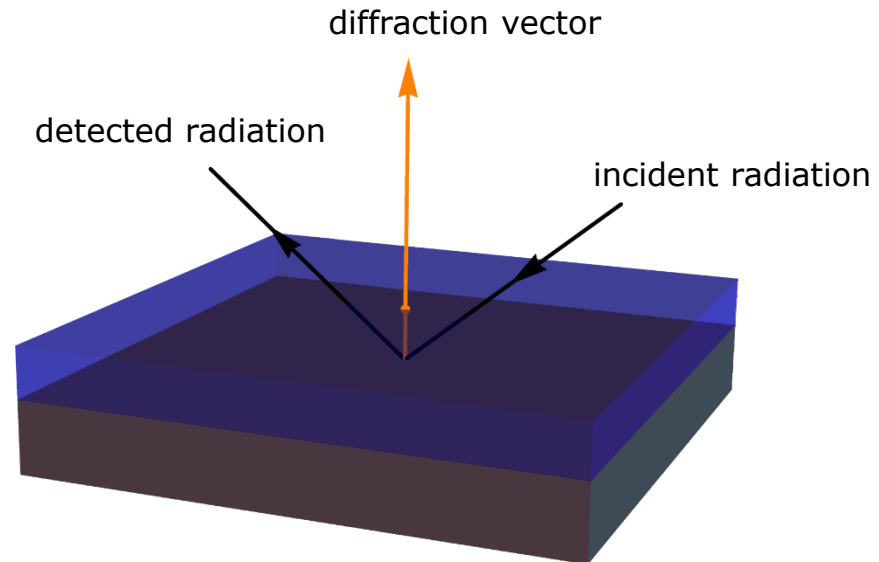



Controlling X-ray penetration depth in the stress investigation

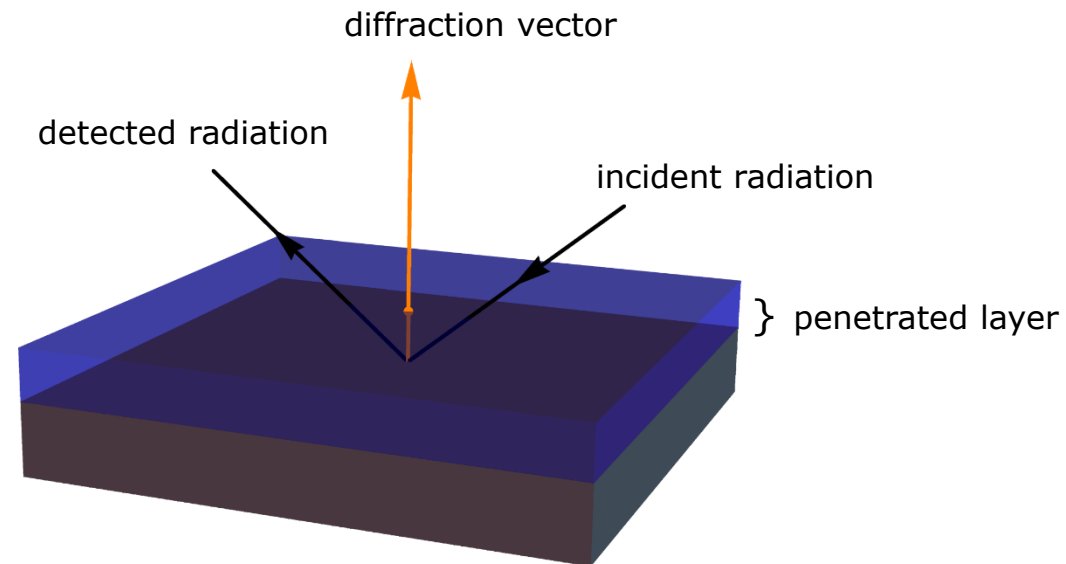



Controlling X-ray penetration depth in the stress investigation

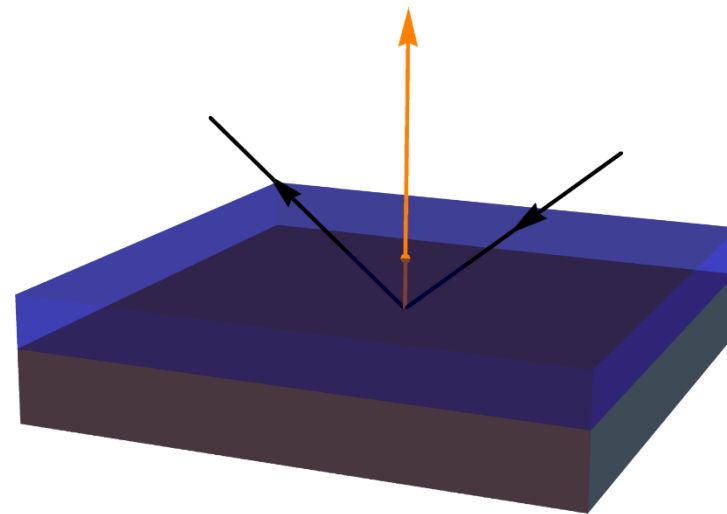

standard $\sin^2\psi$ measurement



Controlling X-ray penetration depth in the stress investigation

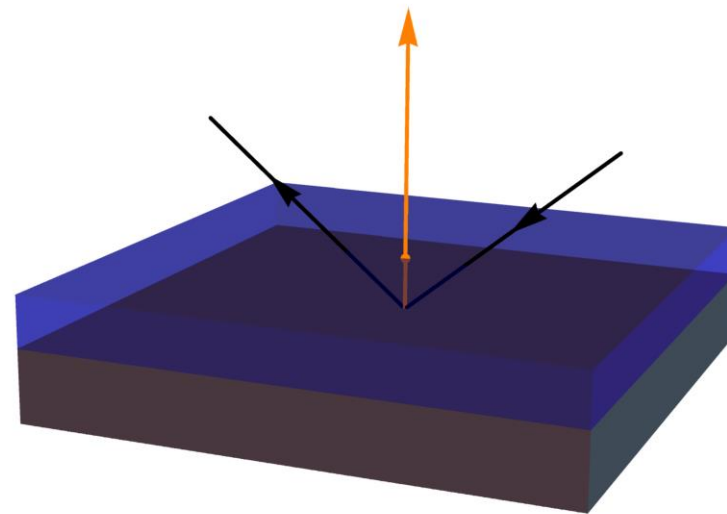

standard $\sin^2\psi$ measurement



Controlling X-ray penetration depth in the stress investigation

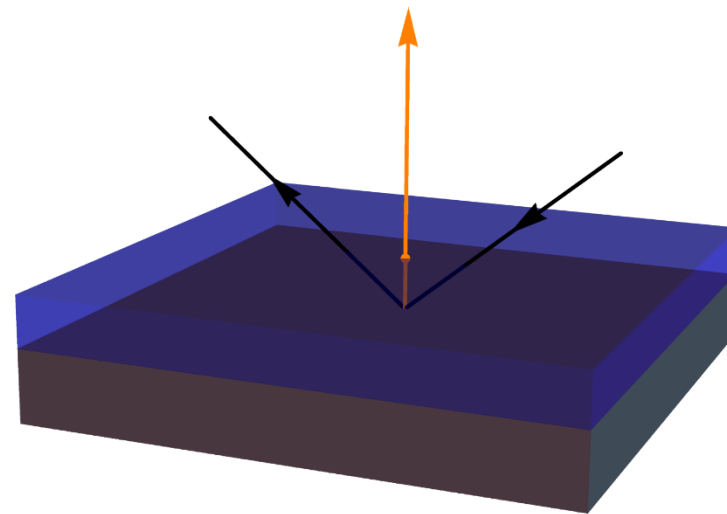

tomographic measurement



Controlling X-ray penetration depth in the stress investigation

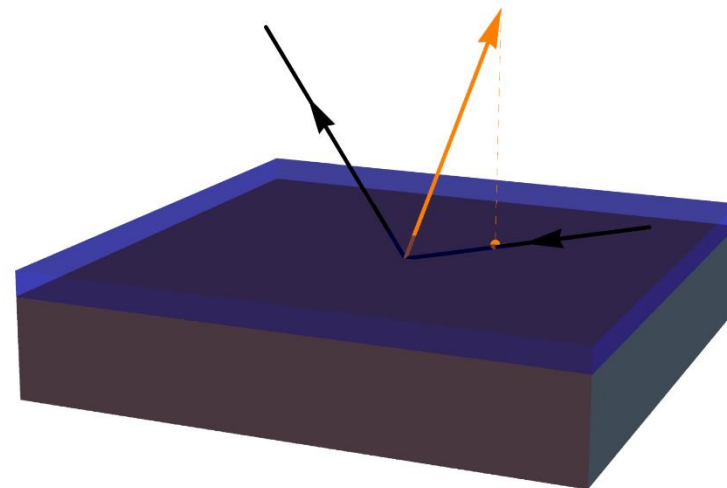

tomographic measurement



Controlling X-ray penetration depth in the stress investigation

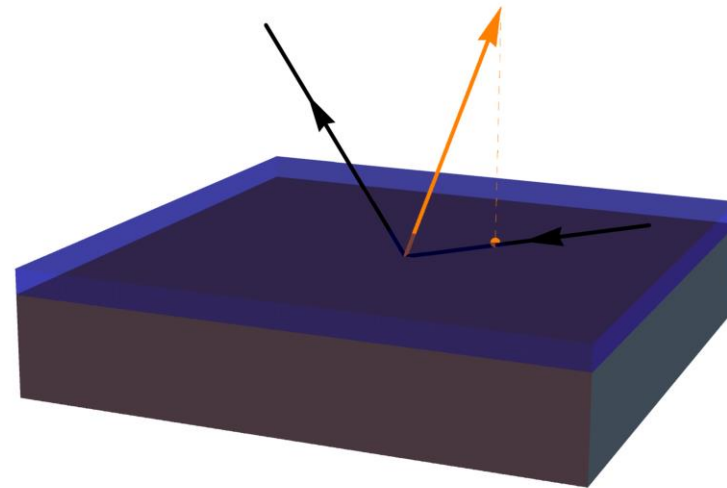

tomographic measurement



Controlling X-ray penetration depth in the stress investigation

for any ψ -tilt direction of the measurement
can be freely adjusted

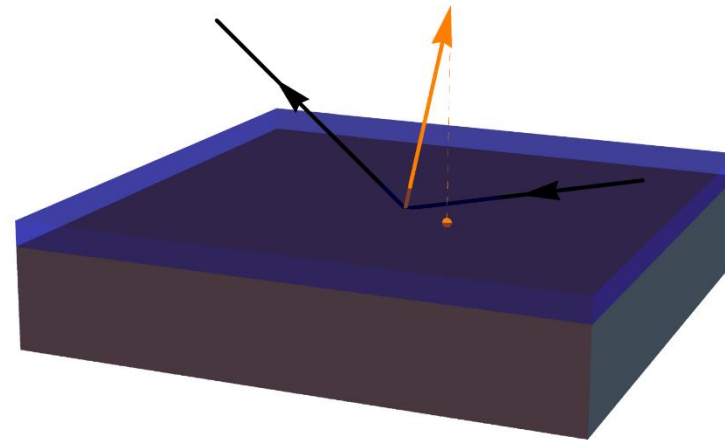

tomographic measurement



Controlling X-ray penetration depth in the stress investigation

for any ψ -tilt direction of the measurement
can be freely adjusted

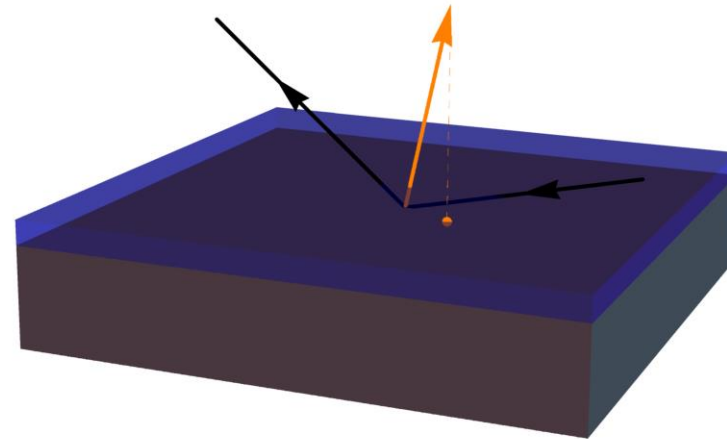

tomographic measurement

Modification of the method $\sin^2 \psi$

(measurement of stresses in layers - tomographic measurement)

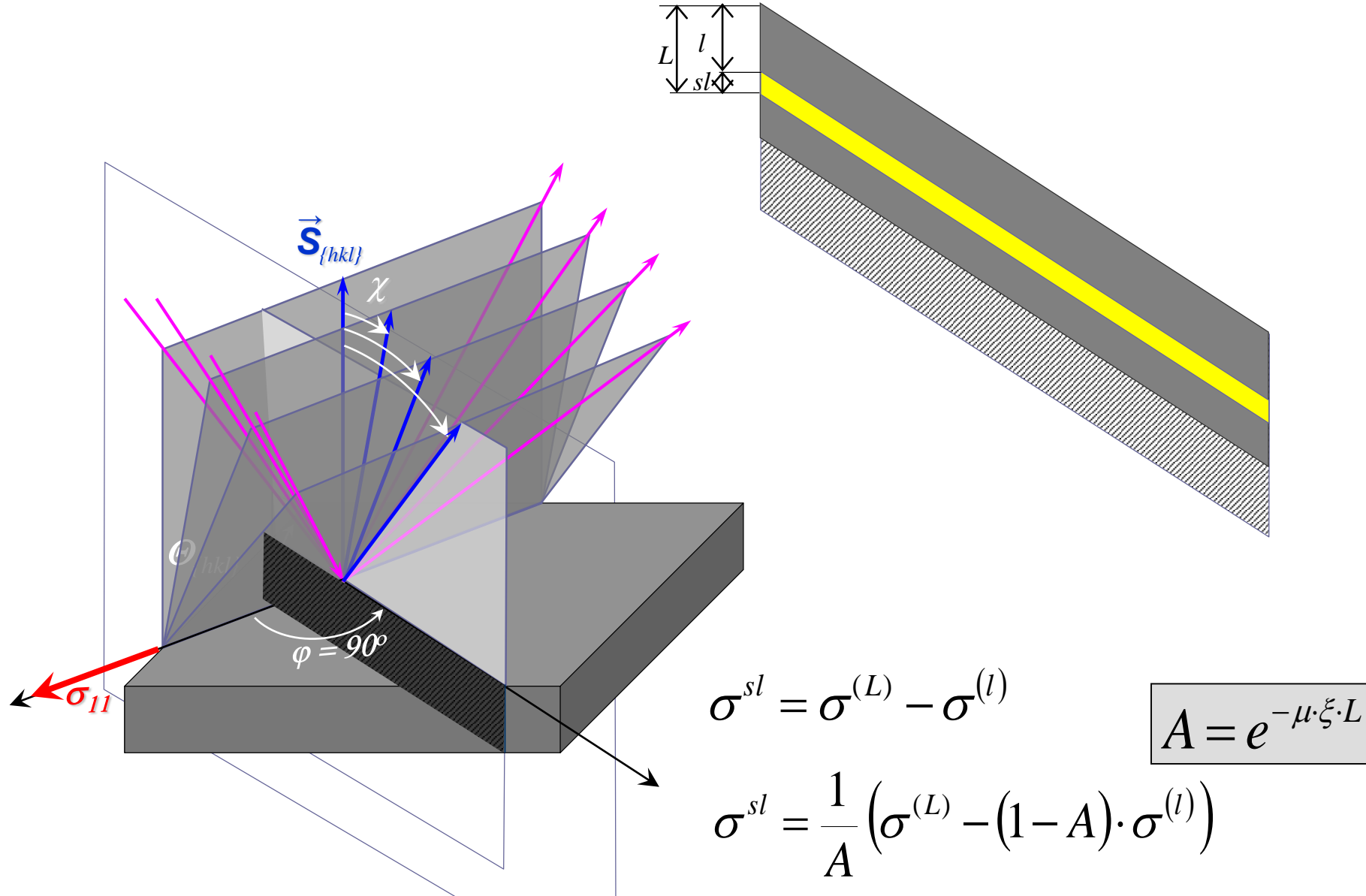



Controlling X-ray penetration depth in the stress investigation

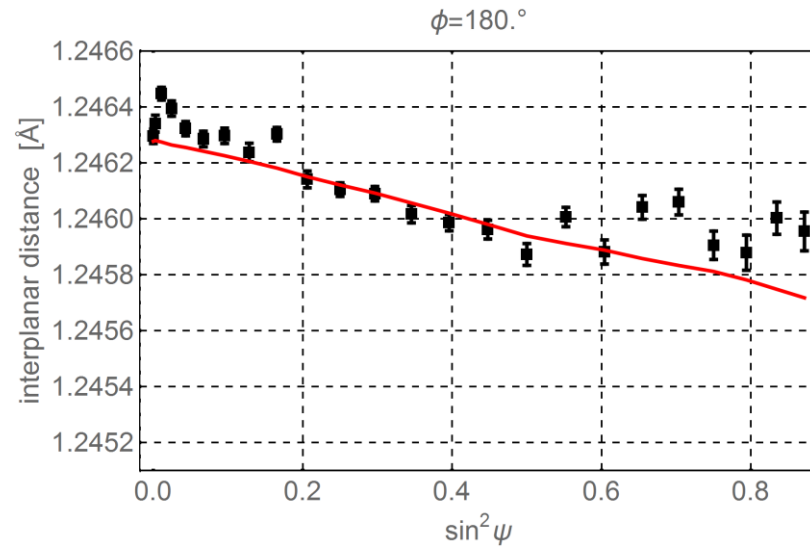

standard investigation

$$\sigma_\phi = -205 \pm 20 \text{ MPa}$$

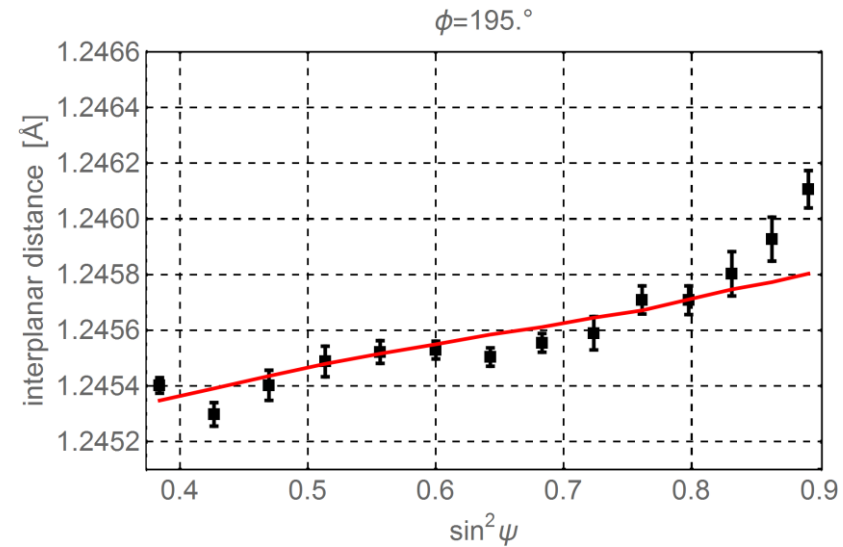

tomographic investigation

$$\sigma_\phi = +195 \pm 10 \text{ MPa}$$

3.5 μm Ni electrodeposited coating on Ni substrate



Controlling X-ray penetration depth in the stress investigation

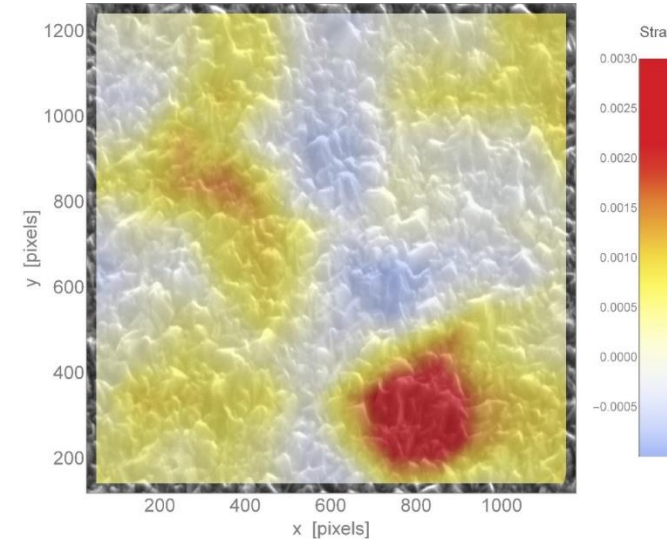
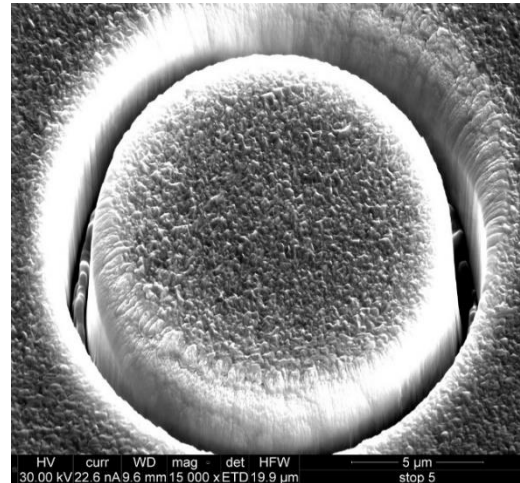
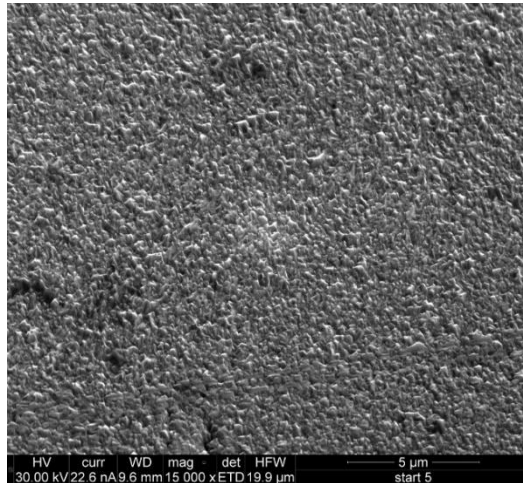

$$\sigma = +200 \text{ MPa}, \text{ not } -200 \text{ MPa}$$

3.5 μm Ni **electrodeposited** coating on Ni substrate



Flexible measurement grid selection for stress and texture investigation

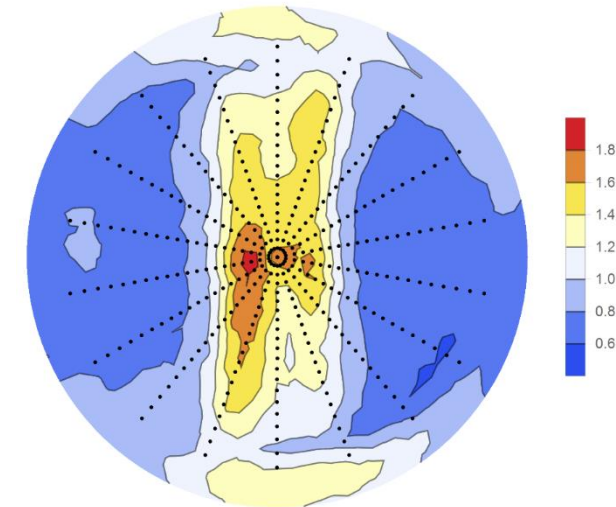
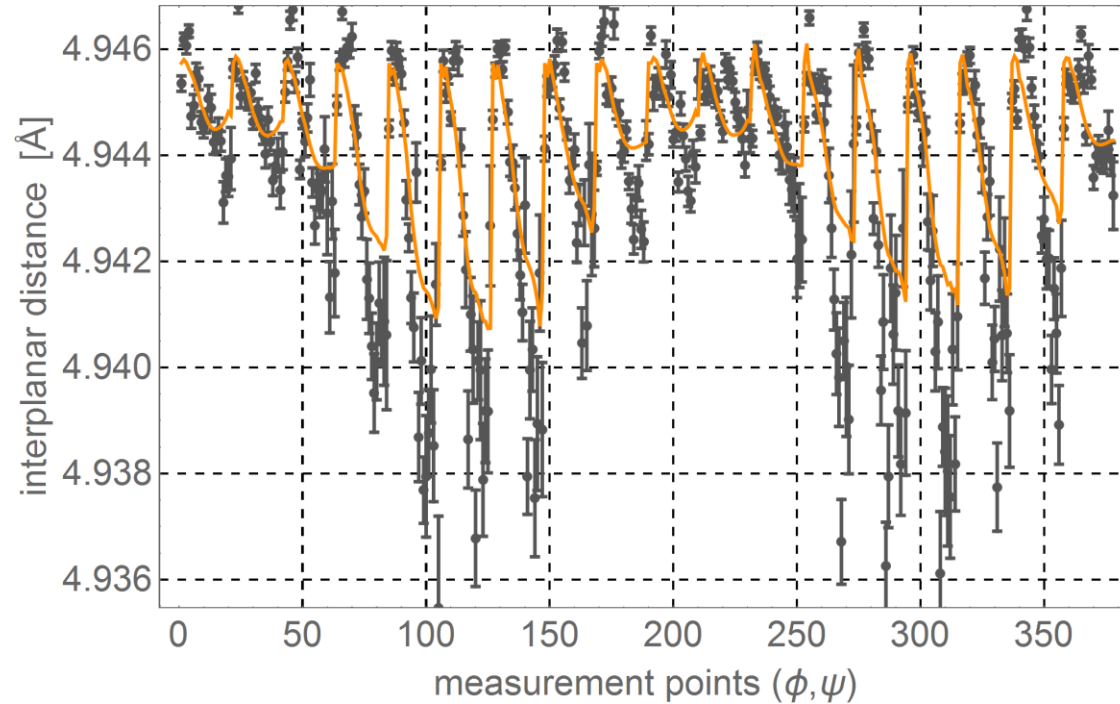

$$\sigma_{hi} = -65 \pm 5 \text{ MPa} ?$$

002 Zn, extruded Zn-Mg alloy, Mg 1.5% wt



Flexible measurement grid selection for stress and texture investigation

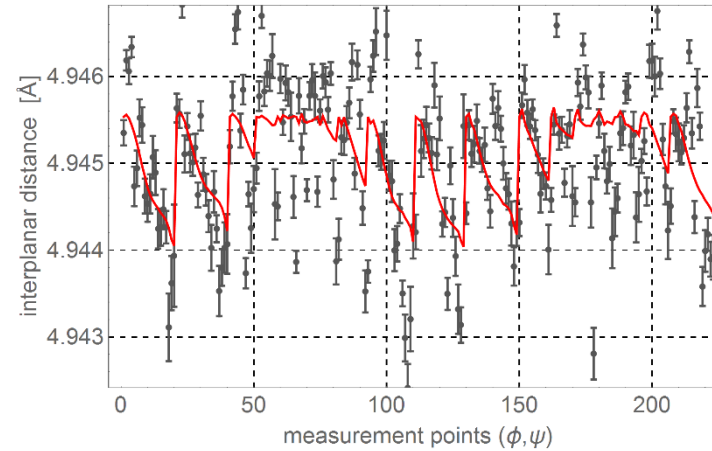
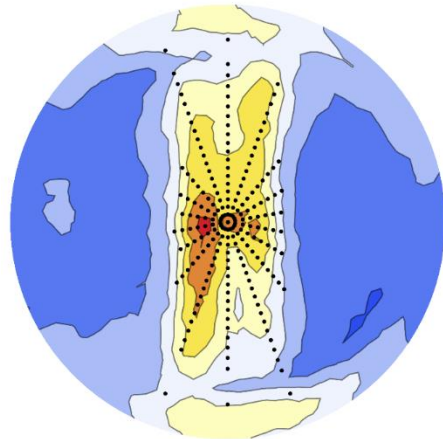

$$\sigma_{hi} = -25 \pm 5 \text{ MPa}$$

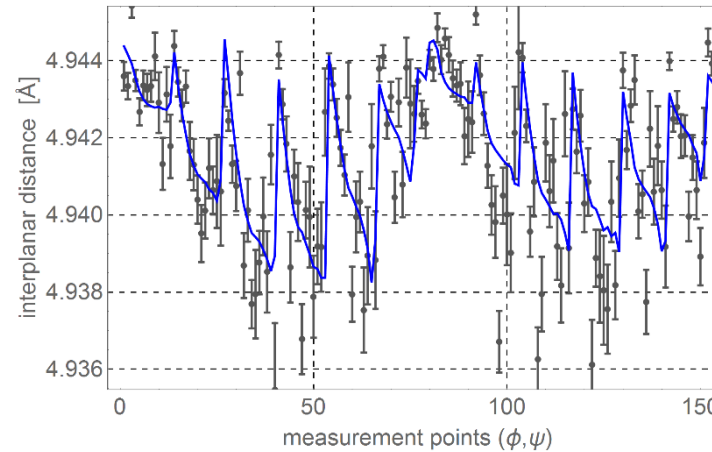
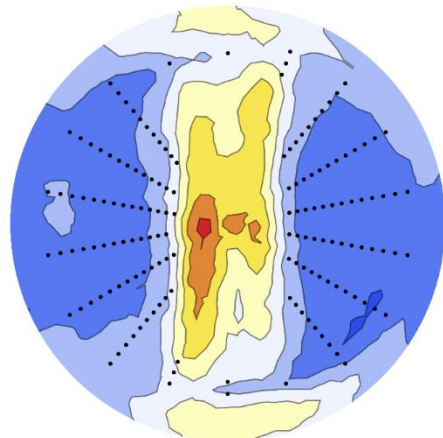

$$\sigma_{hi} = -130 \pm 10 \text{ MPa}$$

002 Zn, extruded Zn-Mg alloy, Mg 1.5% wt

Project WND-PCWR.1.02.00-00-10-13/16



Texture-induced mechanical anisotropy

Austenite Young modulus
surface

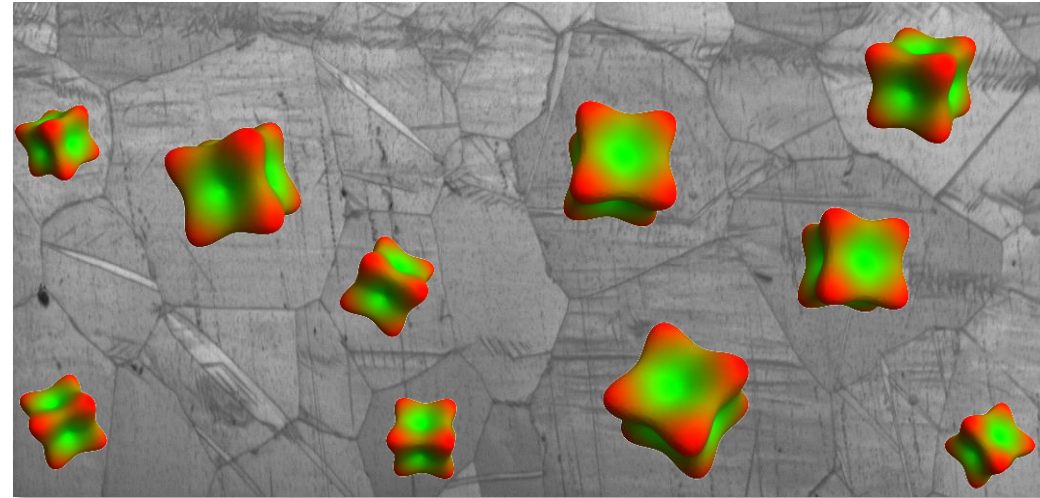
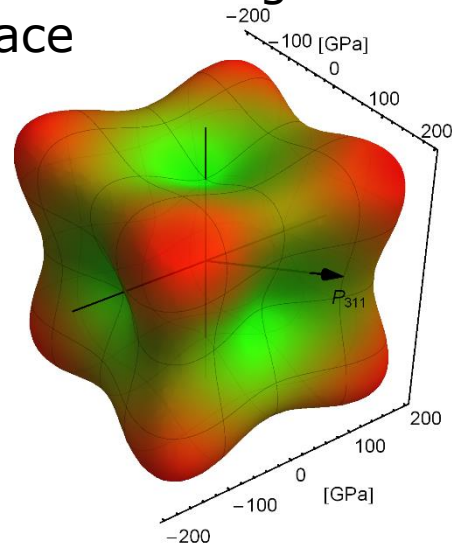

$$\varepsilon_{\phi\psi}^L(\varphi, \psi, hkl) = F_{ij}(\varphi, \psi, hkl) \sigma_{ij}$$



Texture-induced mechanical anisotropy

Ni cold rolled substrate

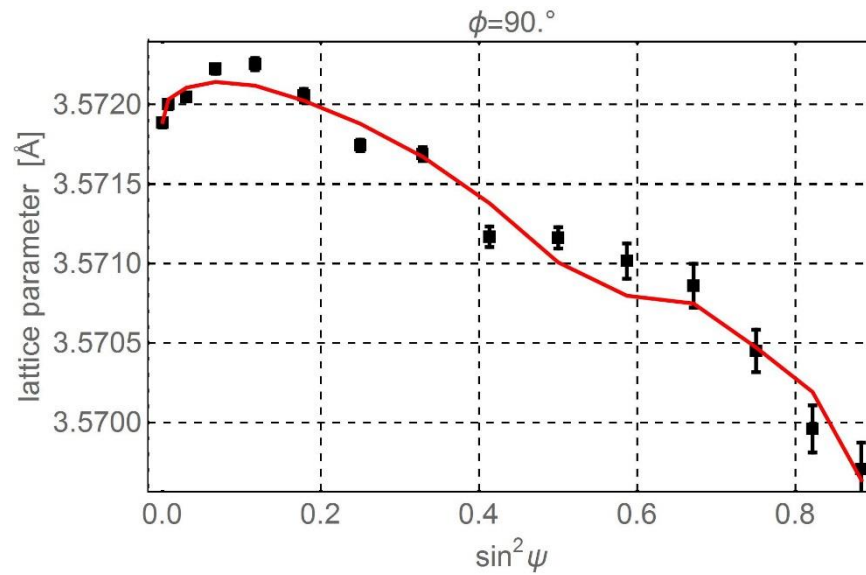

$$\sigma_{\phi} = -280 \pm 10 \text{ MPa}$$

Ni coating on Ni substrate

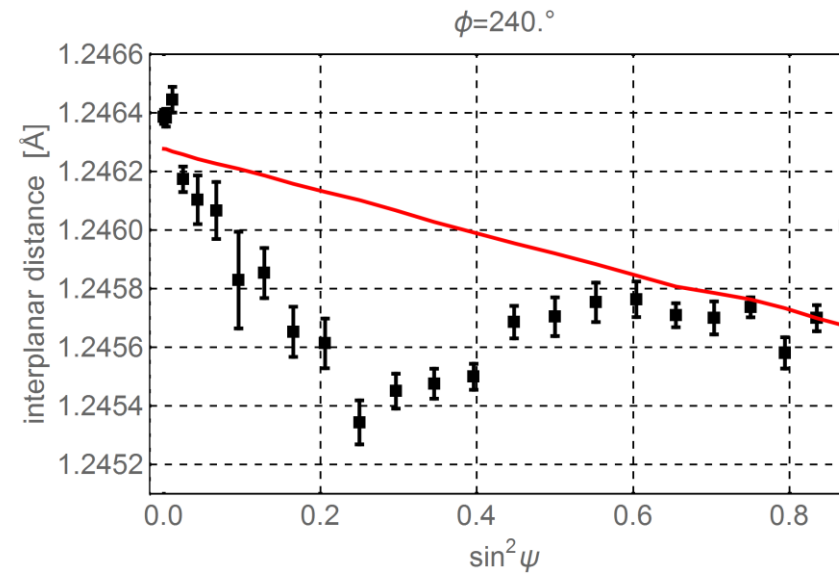

Possible stress and texture
depth gradient



Texture-induced mechanical anisotropy

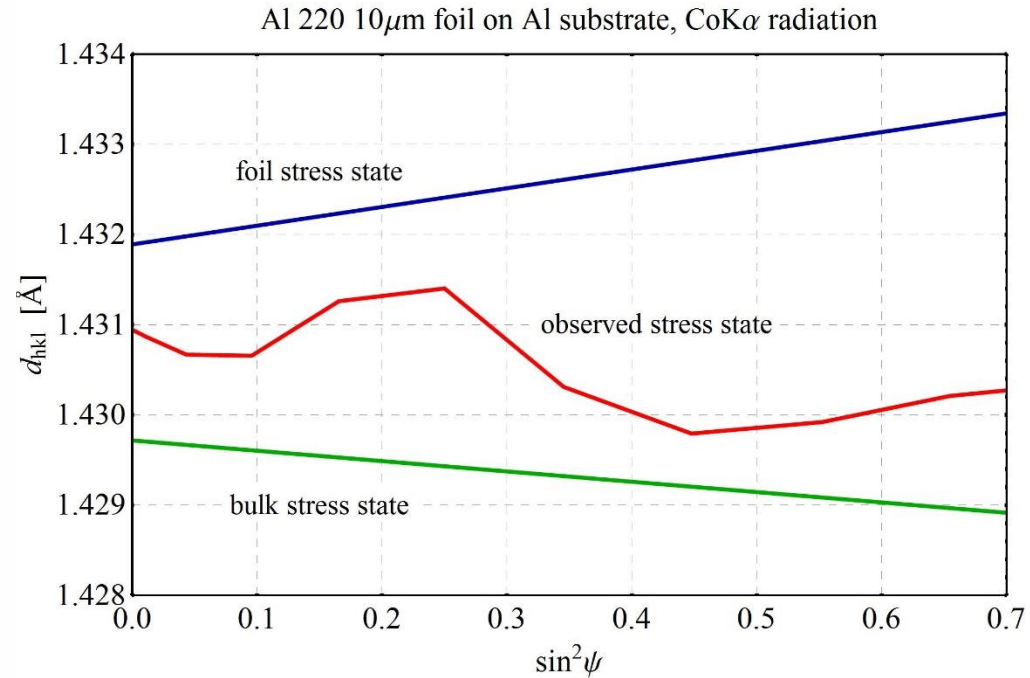
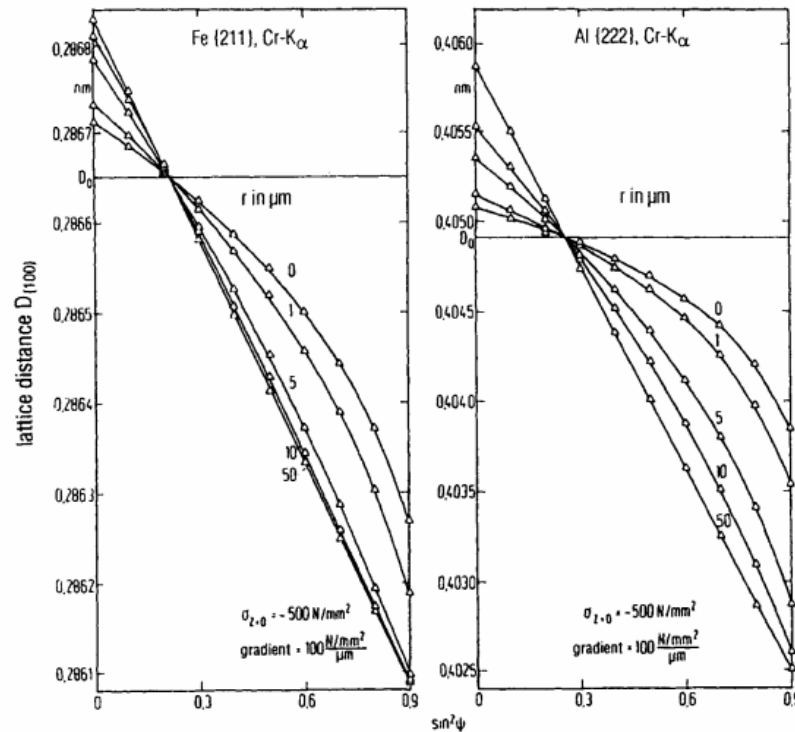

V. Hauk, W.K. Krug: Der theoretische Einfluß tiefenabhängiger Eigenspannungszustände auf die röntgenographische Spannungsermittlung II. Härterei-Tech. Mitt. 39 (1984), 273-279.



Applications of proposed methodology of XRD residual stress investigation

- Thin functional coatings investigations
- 3D printed and severe deformed materials studies
- Stress and texture mapping

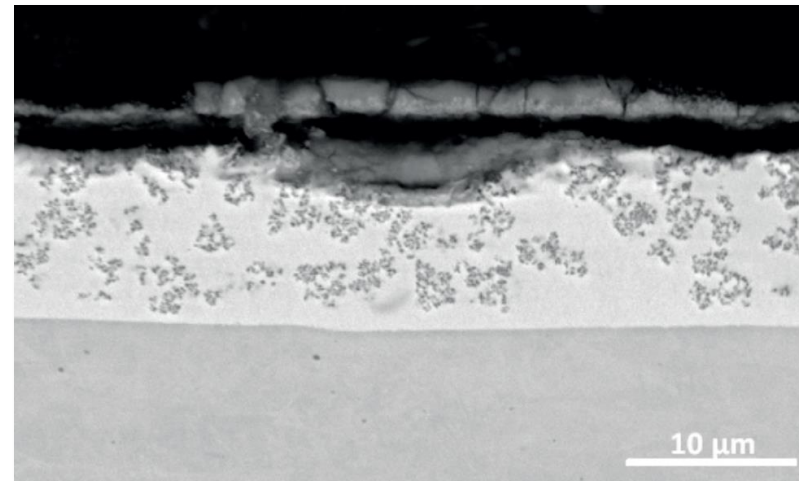
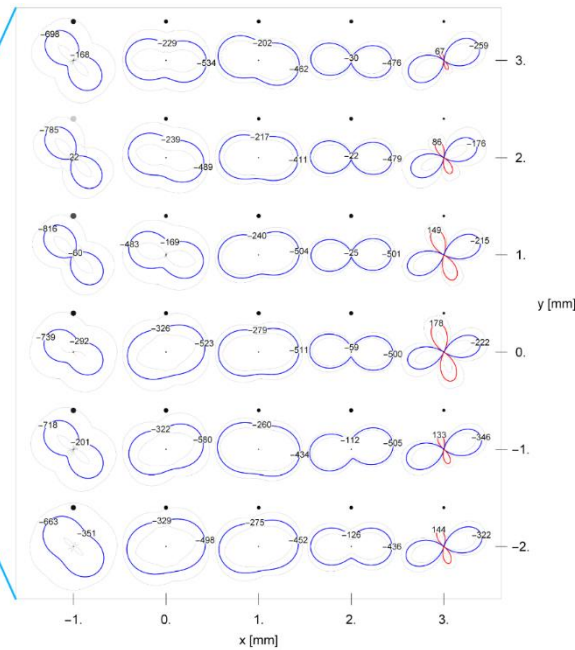
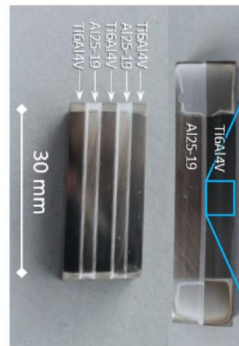
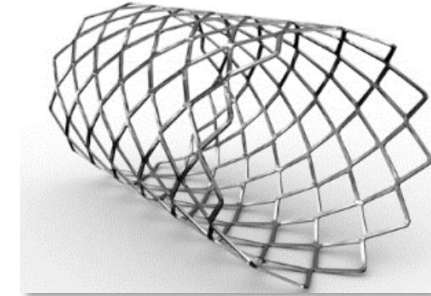



Thank you for your attention