

## NOVEL METHOD OF THERMAL CONDUCTIVITY MEASUREMENT USING STEFAN-BOLTZMANN LAW

The article presents a novel method that allows measurement of thermal conductivity that is based on Stefan-Boltzmann law. The developed method can be used to determine thermal conductivity of ceramic investment casting molds. The methodology for conducting thermal conductivity tests of ceramic material samples is presented. Knowledge of the value of thermal capacity and thermal conductivity as a function of temperature enables computer simulations of the process of cooling and solidification of liquid metal in a mold.

*Keywords:* thermal conductivity, thermal radiation, ceramic shell molds, aluminum castings

## 1. Introduction

The coefficient of thermal conductivity belongs to the group of physical parameters necessary for simulations of foundry processes conducted by numerical methods. So far, the values of this coefficient as a function of temperature have been determined for very few materials only. Technical literature gives values of the coefficient of thermal conductivity for materials with a homogeneous structure which is substantially different from the structure of ceramic casting molds.

## 2. Thermal conductivity measurements

Heat transport through the layer of porous ceramic material takes place by conduction and radiation.

In order to conduct a correct simulation of the aluminum alloy casting process, it is required to know the coefficients of thermal conductivity in the range of solidification and cooling temperatures, i.e. from 400°C to 850°C.

The heterogeneous structure of investment casting molds significantly impedes the measurement of their thermal conductivity [1].

The amount of energy transferred through a unit of area in a unit of time is described by the Fourier differential equation as shown below:

$$\frac{\partial Q}{\partial t} = -k \oint_S \nabla T \cdot dS, \text{ W} \quad (1)$$

where:

$Q$  – amount of heat, transferred through sample in time  $t$ , J,

$k$  – thermal conductivity, W/(m·K),

$\nabla T$  – temperature gradient, K/m,

$dS$  – surface area element, m<sup>2</sup>.

For a steady heat flow through a flat sample with parallel walls, after integration, the Fourier equation can be written in the following form:

$$\frac{Q}{t} = \left( \frac{k}{d} \right) A (T_b - T_t), \text{ W} \quad (2)$$

where:

$d$  – thickness, m,

$A$  – surface area, m<sup>2</sup>,

$T_b, T_t$  – temperature of the bottom and the top of the sample, K.

In laboratory based research, a plate apparatus are used to measure the thermal conductivity that allows measurements of the materials characterized by low heat conductivity (ceramics). The principle of measurement consists in determining the amount of heat transmitted through a flat parallel test sample, heated on one side with a flat radiator, on the other side, cooled by a flat water cooler. The thermal conductivity then can be calculated from the formula shown below [2]:

$$k = \frac{(Q/t)d}{A(T_b - T_t)}, \text{ W/(m·K)} \quad (3)$$

## 3. Novel idea of thermal conductivity measurements

Investment casting molds are characterized by different properties of both their surfaces. The inner surface which is in contact with a liquid metal has low roughness in order to obtain

\* FOUNDRY RESEARCH INSTITUTE, 73 ZAKOPIAŃSKA STR., 30-418 KRAKÓW, POLAND

# Corresponding author: wojciech.lesniewski@iod.krakow.pl

the best quality of casting. The outer surface of the mold shows the surface corresponding to the grain size of the ceramic material used for the last mold layer. The thickness of the mold is strictly related to the number of ceramic layers, and the grain size of the ceramic material that was used, however due to different parameters of the ceramic materials the thermal properties of such materials vary significantly. Large grain size of the external surface precludes the use of plate apparatus for measurements. The grinding of the surface required in this case significantly changes the way the heat is discharged.

The design of the new apparatus developed by the authors of this work allows for determination of thermal conductivity of ceramic samples taking into account the fact that when a liquid metal is pouring into ceramic mold, its internal surface provides very good contact with a liquid metal, while its external surface discharges heat into the space mainly through the emission of thermal radiation.

In this work it was assumed that when the heat flowing through the ceramic plate is radiated to the half-space by thermal radiation, then the value of  $Q/t$  can be calculated from the well-known Stefan-Boltzman equation. The equation defines the power radiated by the unit surface to the half-space.

$$\left(\frac{Q}{t}\right) = n^2 \sigma T^4, \text{ W} \quad (4)$$

where:

- $n$  – index of refraction,
- $\sigma$  – Stefan-Boltzmann constant,  $5.670 \cdot 10^{-8} \text{ W}/(\text{m}^2 \cdot \text{K}^4)$ ,
- $T$  – temperature, K.

The calculations assume that the refractive index,  $n$ , equals 1 and that the calculated power is related to the unit surface [2-4].

$$k = \frac{\sigma T^4 d}{A(T_b - T_t)}, \text{ W}/(\text{m} \cdot \text{K}) \quad (5)$$

The presented formula that allows calculation of thermal conductivity can be considered correct if it is assumed that the energy sent from the sample can be determined by the Stefan-Boltzmann equation, i.e. there is no convective air movement over the sample and that the emissivity is equal to 1. These assumptions are sufficiently accurate because above 573 K thermal energy radiated by a measuring object, which is proportional to  $T^4$ , reaches values exceeding the energy occurring in other forms of heat transport. The outer surface of a casting mold is usually significantly developed, which is why the calculation assumes that the emissivity is equal to 1. The designed construction of the new device is shown in Fig. 1.

In order to measure thermal conductivity, the heating chamber (2) was closed with the sample (6). The bottom surface of the sample (6) is constantly in contact with a thermocouple (5). The heating power of the measuring device is adjusted by the control system (9) in order to obtain the expected temperature of the bottom surface the sample. When the thermal conditions are stable, the temperature of the bottom surface is measured by a thermocouple (5), the temperature of the top surface of the sample is measured by pyrometer (13).

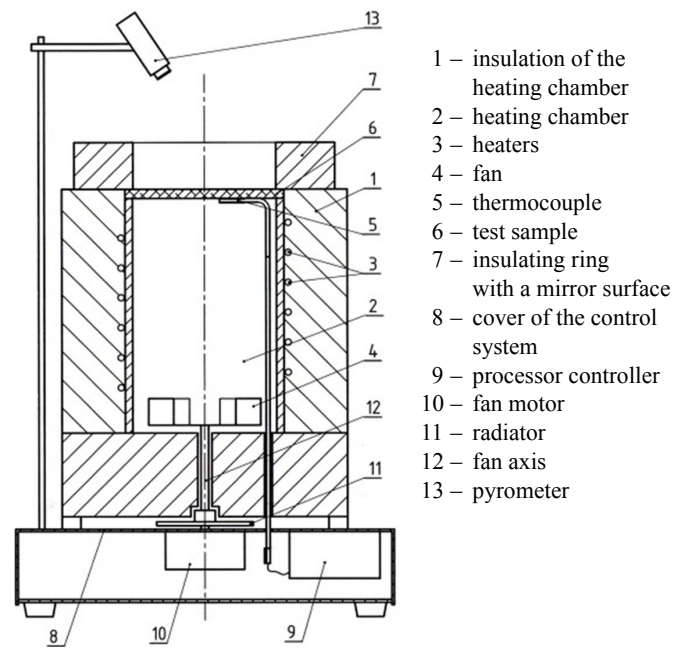

Fig. 1. Construction of apparatus for determining thermal conductivity of ceramic shell samples

Ring (7) prevents the occurrence of convection movements above the surface of the ceramic tile and its inner mirror surface allowed in this situation the emission of thermal radiation to the half-space [5].

#### 4. Making samples of multi-layer ceramic molds

Ceramic samples were prepared in silicone molds, the cavities of which were reproduced by aluminum discs with a diameter of 82 mm and a thickness of 6, 9 and 12 mm.

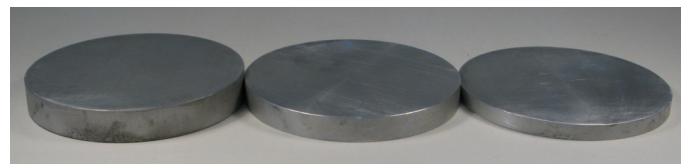

Fig. 2. Aluminum discs reproducing the silicone mold cavity



Fig. 3. Molds made from silicone rubber

The silicone molds were filled with successive layers of ceramic material until the required thickness was obtained. Then

the samples were dried and after being taken out of the mold they were baked at 1000°C.

Flours with the grain size typical for the casting process were used, as well as the silica sand SiO<sub>2</sub> and zircon sand ZrO<sub>2</sub>, and binder based on an aqueous solution of colloidal silica.

The first layer and the second layer of the sample were made from the sand with a grain size of 0.1 to 0.3 mm. For the next layers, the sand with a grain size of 0.5 to 1 mm was used.

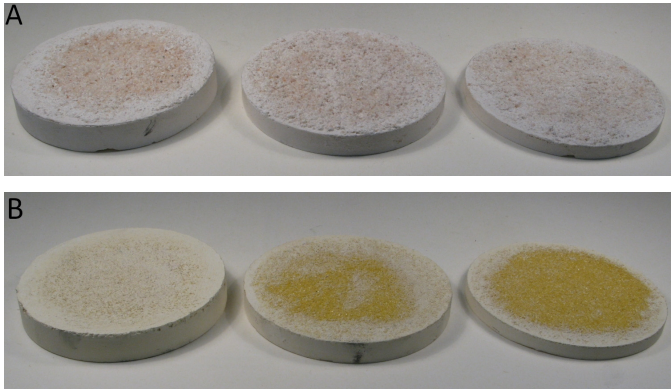

Fig. 4. Samples of multi-layer ceramic samples: A – quartz, B – zirconium dioxide

### 5. Measurements

The first step in the measurements involved placing the previously prepared disc-shaped sample of ceramic material in the heating chamber. The pyrometer location was controlled with a laser indicator showing the measurement field. A pyrometer operating in the spectral range of 8-14 μm was used for the measurements. The measuring range was from 0°C to 900°C.

The center of the measurement field was positioned over the tip of the thermocouple measuring the temperature of the lower surface of the ceramic sample. The measurement process was controlled by a computer program in which the measurement parameters were determined, including time necessary to reach the preset temperature and time of recording. The adopted values of measurement temperatures ranged from 400°C to 900°C.

After setting the algorithm, the measurement was activated. The program controlling the real-time measurement process presents graphs of temperature changes determined by the thermocouple and the pyrometer. After completing the measurement algorithm, the program controls the cooling process of the furnace heating chamber. The recorded data can be exported to an .xls file.

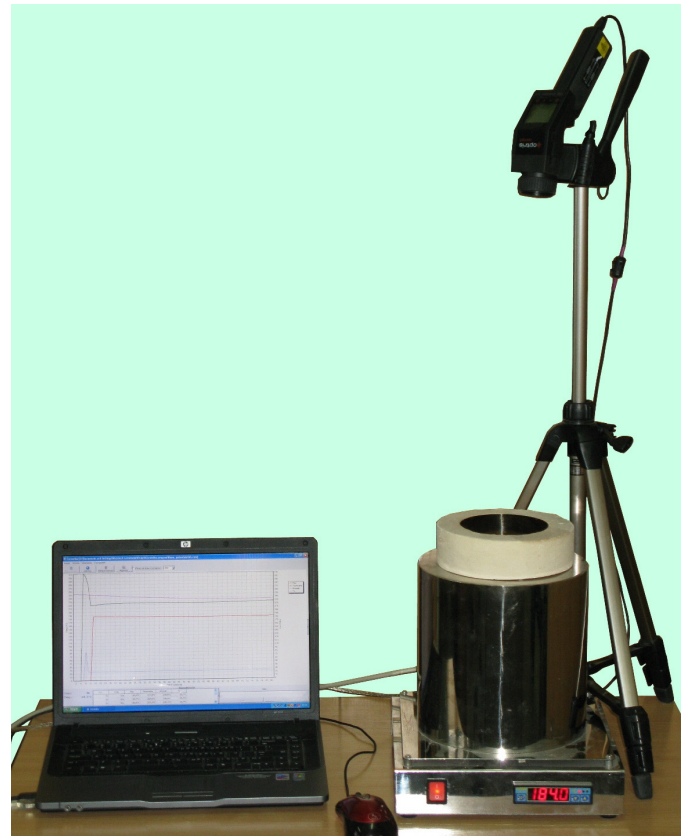

Fig. 5. Stand for measurement of the coefficient of thermal conductivity of ceramic materials

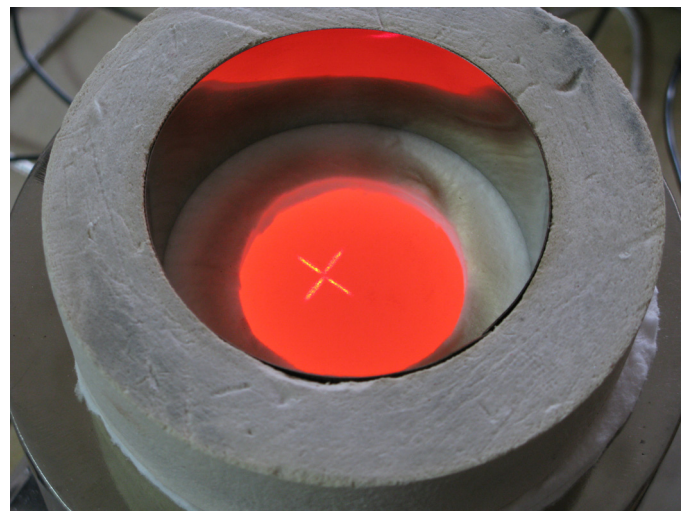

Fig. 6. The hot surface of the ceramic sample with a well-visible cross indicating the measurement field of the pyrometer

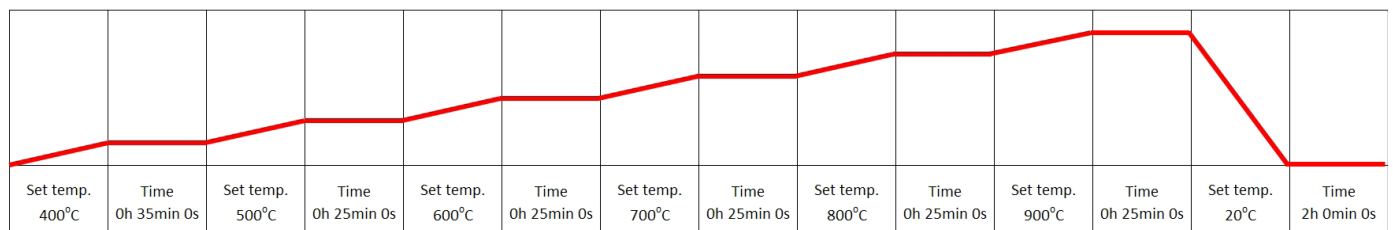

Fig. 7. Algorithm for device operation control

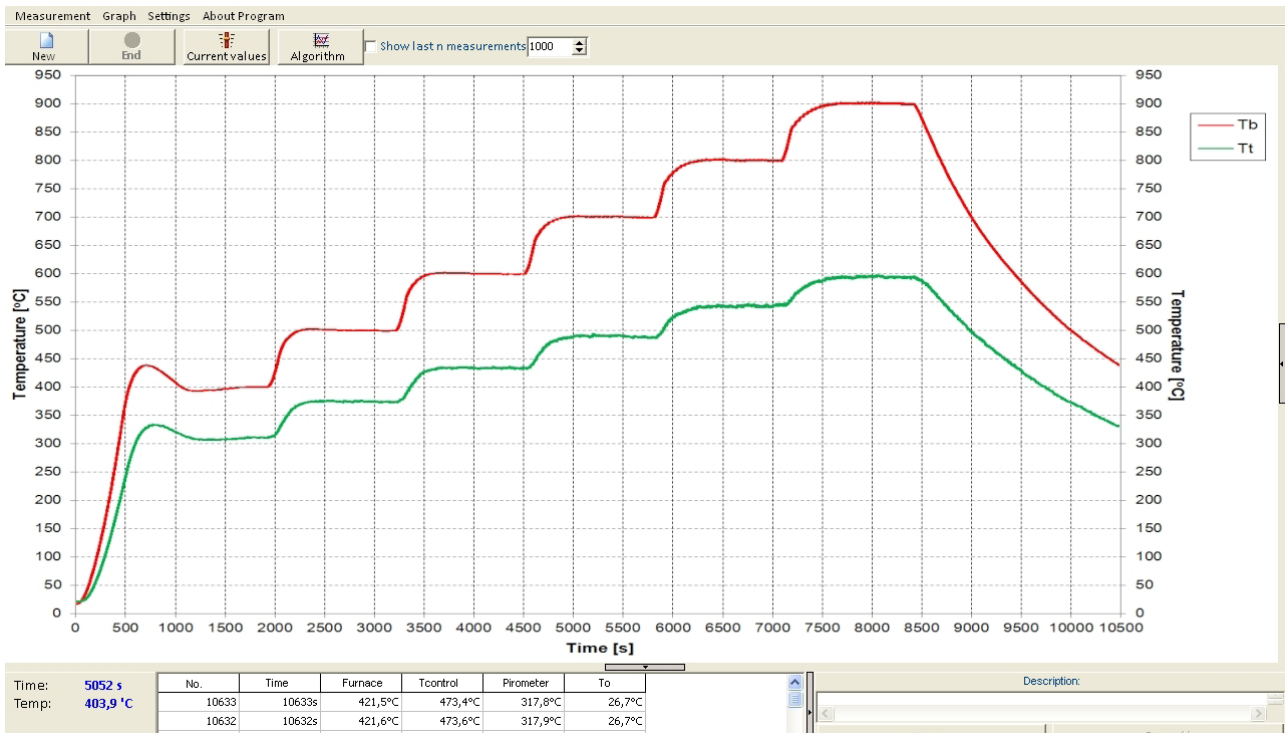

Fig. 8. Temperature changes recorded during measurement

### 6. Discussion of results

In homogeneous materials, the coefficient of thermal conductivity does not depend on the thickness of the sample.

The tested samples of materials are composed of distinctly different layers. In a foundry mold, the bottom layer of the sample is the surface entering in direct contact with the liquid metal and therefore very smooth and with nearly no porosity.

The outer (upper) layer is characterized by high degree of roughness. Samples of different thicknesses have proportionally different thicknesses of individual layers with different grain size changing the heat conduction.

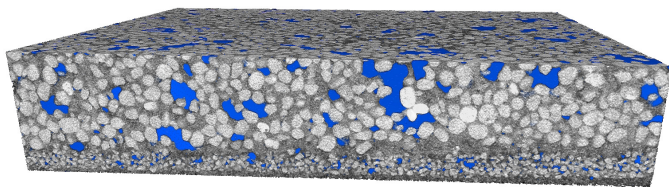

Fig. 9. View of the sample cross-section with porosities marked in blue color – CT image

Table 1 presents the results of calculations of the coefficient of thermal conductivity carried out for a 6 mm thick sample of zircon dioxide.

The measurement result is calculated for the average temperature value measured on the top and bottom surface of the sample [6].

The measurements carried out indicate that the coefficient of thermal conductivity of the ceramic material based on zirco-

TABLE 1

The coefficient of thermal conductivity calculated for a 6 mm thick sample made of zirconium dioxide

Calculated value of temperature [°C]	356,02	437,59	517,11	595,13	672,35	747,72
Coefficient of thermal conductivity [W/m·K]	0,45	0,48	0,51	0,55	0,59	0,63

nium dioxide is higher than that of the quartz-based material. The obtained result is consistent with the literature data.

For fused quartz, the coefficient of thermal conductivity reaches a value of 1.3 to 1.5 W/m·K, while for zirconium dioxide it ranges from 1.7 to 2.7 W/m·K [7-8]. The structure of the obtained material plays an important role in the thermal conductivity of the multi-layer ceramic molds made from granular materials. The area filled with 0.5-1 mm ceramic grains still has a relatively large amount of free space, and contact points formed by ceramic bridges conduct a small amount of heat.

### 7. Summary

The novel method of the measurement of thermal conductivity allows determining the value of this coefficient for porous ceramic materials from which the multi-layer foundry molds are made. The conducted research indicates that it is the structure of the molding material that determines the thermal conductivity. The obtained data can be used in computer simulations to predict the processes of cooling and solidification of aluminum-based alloys in multi-layer ceramic molds.

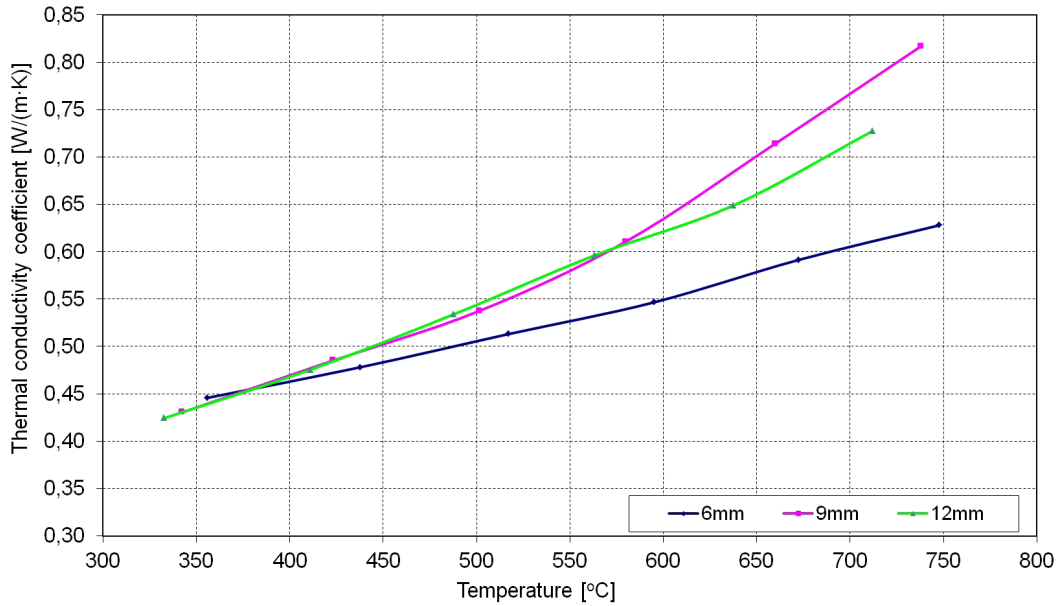

Fig. 10. The course of changes in the coefficient of thermal conductivity of zirconium dioxide samples as a function of temperature

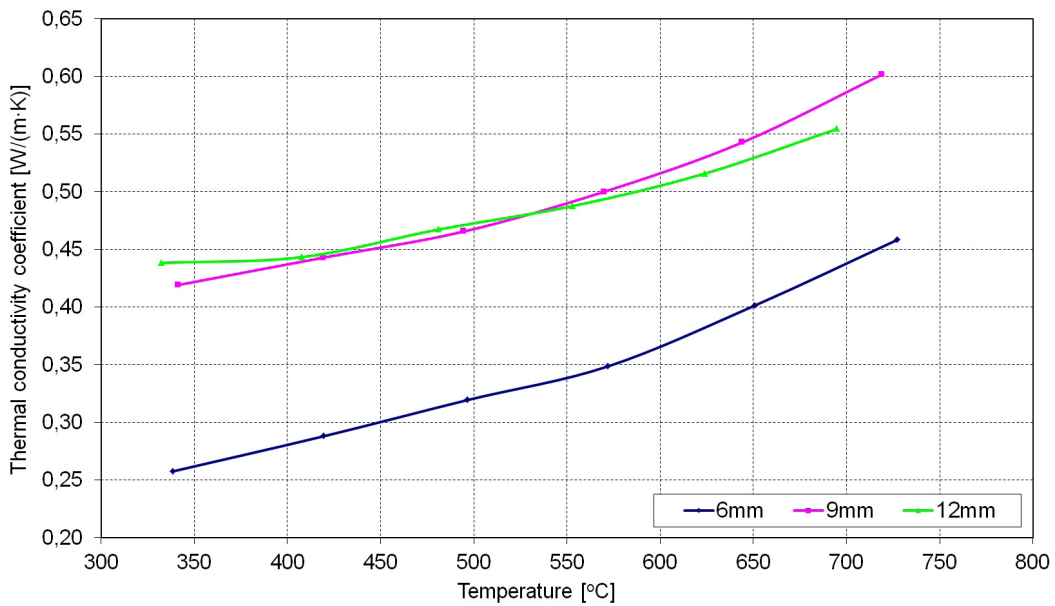

Fig. 11. The course of changes in the coefficient of thermal conductivity of silicon dioxide samples as a function of temperature

#### Acknowledgments

Project co-financed by the European Union through the European Regional Development Fund. Project No.: POIG.01.01.02-00- 015/09 “Advanced Materials and Technologies for their Manufacture”.

#### REFERENCES

- [1] H. Szydłowski, Pracownia fizyczna rozdział IV Ciepło i fizyka molekularna, PWN 1973 Warszawa.
- [2] A. Sala, Radiacyjna wymiana ciepła, WNT Warszawa 1982.
- [3] K.W. Schlichting, N.P. Padture, P.G. Klemens, Journal of Materials Science **36**, 3003-3010, (2001).
- [4] H. Szydłowski Pracownia fizyczna rozdział IV Ciepło i fizyka molekularna, PWN 1973 Warszawa.
- [5] W. Leśniewski, E. Czekaj, Apparatus for measuring thermal conductivity of ceramic materials, 2012, Patent PL-210610. Patent Office of the Republic of Poland.
- [6] W. Leśniewski, M. Wawrylak, P. Wieliczko, A. Gil, M. Małysha, K. Szczepaniak-Lalewicz, Prace Instytutu Odlewnictwa **57**, 4, 259-263 (2017)
- [7] <https://www.azom.com/properties.aspx?ArticleID=133> (2018.10.15)
- [8] <https://www.azom.com/properties.aspx?ArticleID=1114> (2018. 10.15)