

**NUMERICAL-EXPERIMENTAL RESEARCH ON SOME PARAMETERS OF HIP
AND KNEE ENDOPROSTHESES, DETERMINING VALUE AND FORM OF CONTACT STRESS
BETWEEN THEIR ELEMENTS**

The paper presents Finite Elements Method numerical analysis of strength of friction pairs most often used in hip and knee joints alloplasty. Analytic solutions are to indicate and define the areas where damages or premature wear of cooperating elements may occur. Analytical-experimental research states complete and thorough analysis. Accurate technical simulation of the joints of the human motor system, is difficult to conduct due to high level of complexity of human bio-bearings. All attempts to simulate the work of human joints, lead only to an approximate reflection of real human joint motion. To properly face the above problems, along with numerical analysis, there have been conducted empirical tests on the simulator of knee joint endoprosthesis

Keywords: endoprosthesis; stress; strain; FEM

1. Introduction

The aim of this study was numerical analysis of strength, conducted with the Finite Elements Method, applied in knee joints with friction pairs most often used in knee joints prosthesoplasty.

With application of modular endoprosthesis it is possible to properly select friction pairs with respect to the specific biomechanical situation. It is also possible to replace only damaged or worn out friction element of an endoprosthesis, what minimizes the range of an eventual revision procedure.

At the initial study stage, it is appropriate to apply analytic solutions aimed at indicating the areas where damages or premature wear of cooperating elements may occur [1-4].

Nowadays there are lots of various types (hundreds) of knee joint endoprosthesis. Companies producing them, mostly present very complex modular systems (endoprosthesis and implanting instruments) what significantly facilitates the process of optimal implantation itself. Most of modern endoprosthesis basically consist of 3-4 components: femoral, tibia with polyethylene insert of different thickness and patella part [5-8].

The material commonly used for lifting elements in knee joint endoprosthesis, i.e. stem and sleds, is CoCrMo alloy. The

other one, considered as future material is the alloy Ti6Al4V and new generation of Ti alloys such as TiNbZr, TiAlNb [2]. Basic material used for friction elements – inserts, is polyethylene of high density UHMWPE. It means that friction pair of the human motor system in knee joint endoprosthesis is made of metal-polyethylene. The characteristic feature of knee joint endoprosthesis is that all available types of them use polyethylene insert as an element decreasing friction resistance. Polyethylene, despite of its slipping features assuring low friction coefficient, has many disadvantages, like low wear resistance, ageing and creep sensibility. That is why polyethylene inserts are the weakest elements of knee joint endoprosthesis. There are very few publications on the wear of knee joint endoprosthesis; that is what caused the Author to take a closer look at the subject and present it basing on numerical analysis and laboratory tests on simulator [9-12].

2. Method and methodology

All simulations were conducted by using FEM on Autodesk Simulation Mechanical software and the ADINA System, calculating the contact stress in particular elements of the tested model.

¹ CZESTOCHOWA UNIVERSITY OF TECHNOLOGY, FACULTY OF MECHANICAL ENGINEERING AND COMPUTER SCIENCE, DEPARTMENT OF TECHNOLOGY AND AUTOMATION, 21 ARMII KRAJOWEJ AV., 42-201 CZESTOCHOWA, POLAND

* Corresponding author: marcin@jop.pcz.pl



2.1. Numerical analysis of the loads affecting the modular hip joint endoprosthesis

The numerical analysis was performed based on the finite elements method, using Autodesk Simulation Mechanical 2017 software.

The geometric model presented in Fig. 1, consists of real polyethylene cup and head of the hip joint endoprosthesis dimensions, with $\phi 32$ mm. In the stem section, the part closer to the modular set based on widely applied solutions was used. The geometric model was built using Autodesk Inventor Professional 2017 software. Due to the way of virtual fastening, the geometric model of the cup did not have so-called “longitudinal cuts” that counteract the rotation of the cup [13-15].

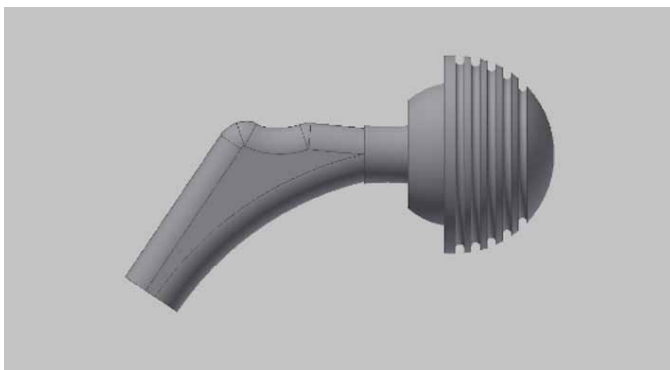

Fig. 1. Geometric model

The system of restraints and loads was based on the active model of hip joint with load, modified and simplified for the purpose of the simulation. The values of loads were assumed on the basis of the literature data [16,17].

The following values were assumed:

- P1 = 700 N – load resulting from a patient’ weight,
- P2 = 50 N – loads resulting from the work of muscles.

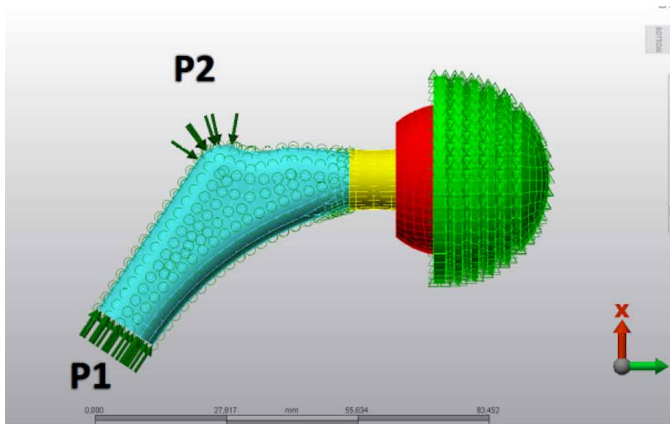

Fig. 2. Model of the loads affecting the analyzed system

In the tribological sphere of the cooperating pair, with the head moving around the cup, friction coefficient $\mu = 0,2$, at contact point.

In the examples in question, the following material combinations were analyzed:

TABLE 1

Combination of biomaterials

Number of association	Stem	Head	Cup
1.	Ti6Al4V	Al ₂ O ₃	UHMWPE
2.	Ti6Al4V	CoCrMo	UHMWPE
3.	Ti6Al4V	Ti6Al4V	UHMWPE

The parameters of the materials assumed in the analysis:

TABLE 2

Mechanical features of biomaterials

Element of the model	Young’s module [MPa]	Poisson’s coefficient n
Alloy CoCrMo	$2,0 \times 10^5$	0,3
Alloy Ti6Al4V	$1,1 \times 10^5$	0,3
UHMWPE	$1,0 \times 10^3$	0,4
Ceramics Al ₂ O ₃	$3,8 \times 10^5$	0,22

The following figures illustrate the example stress and strain distributions for the pair: stem – Ti6Al4V, head – CoCrMo, cup UHMWPE.

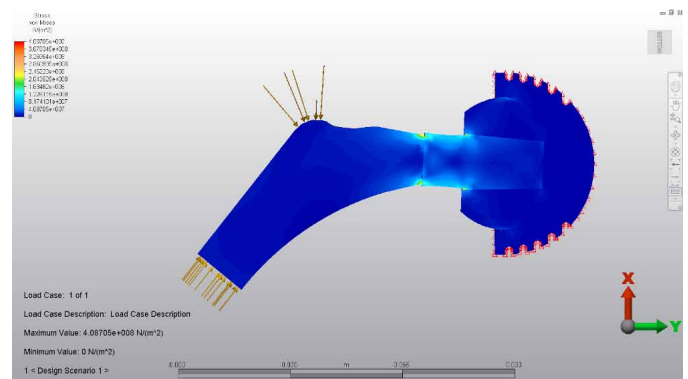

Fig. 3. Stress distribution for the pair: stem – Ti6Al4V, head – CoCrMo, cup UHMWPE

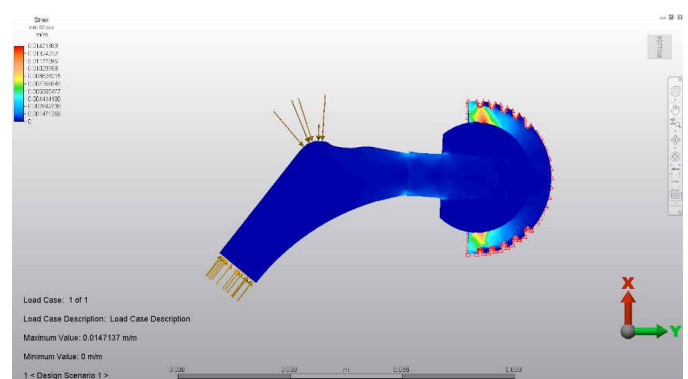

Fig. 4. Strain distribution for the pair: stem – Ti6Al4V, head – CoCrMo, cup UHMWPE

Figure 5 illustrates specification of the maximum stresses in the analyzed configurations. The highest values of stresses were obtained for the pair: stem – Ti6Al4V, head – Al₂O₃, cup UHMWPE, with the maximum value on the level of 416 MPa. A lower value of stresses 408 MPa was obtained for the pair: stem – Ti6Al4V, head – CoCrMo, cup UHMWPE; while the lowest value 391 MPa – for the configuration: stem – Ti6Al4V, cup UHMWPE. The concentration of the stresses in all the cases was placed in the contact area of the endoprosthesis' stem with its head. It should be noted that it is a modular endoprosthesis, and therefore there is a contact between the tapered surface of the stem and the internal part of the opening in the head in this place. Figure 6 illustrates enlarged area including the maximum values of stresses for the association: stem – Ti6Al4V, head – CoCrMo, cup UHMWPE.

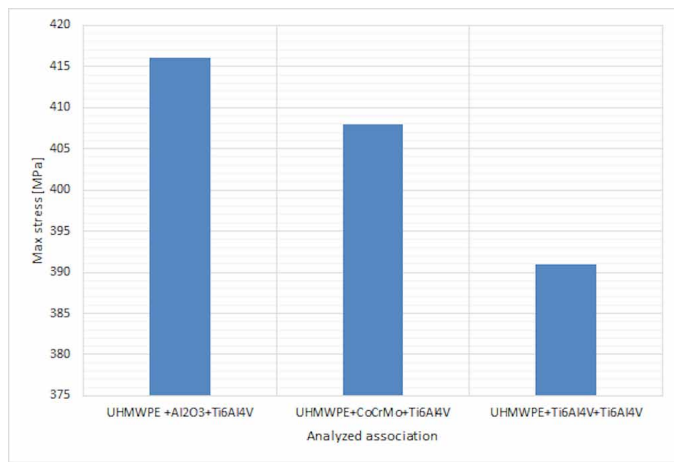

Fig. 5. Values of the maximum stresses with the analyzed pairs

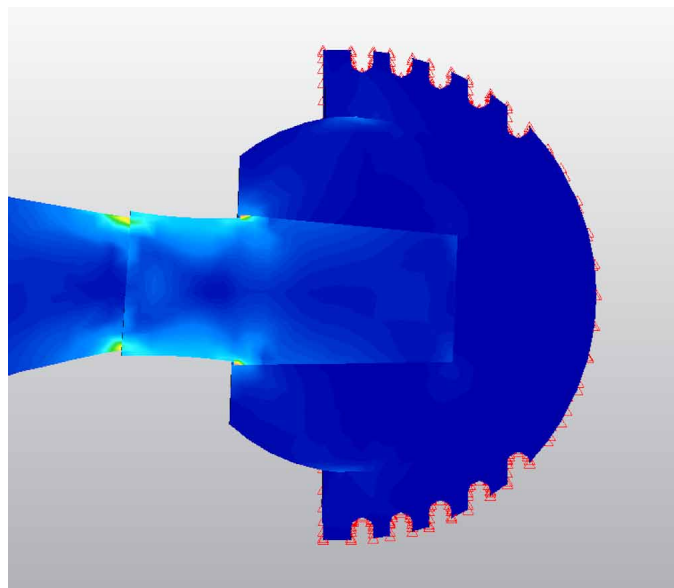

Fig. 6. Enlarged area including the maximum values of stresses for the association: stem – Ti6Al4V, head – CoCrMo, cup UHMWPE

In all the analyzed cases, the highest values of strains occurred in the cup made of UHMWPE in the area of its contact

with the endoprosthesis head. The maximum strains in all the three cases of pairs oscillated around 0,014 mm. The contact of the endoprosthesis hard head with a relatively flexible material of the cup, could have caused such behavior of the cooperating parts. No displacement of the strains to the deeper parts of the cup has been recorded.

Due to the way of modeling of the adopted system, the proximal part of the endoprosthesis stem, with load applied, underwent the largest displacements. The values of the maximum displacements oscillated around 0,4 mm.

2.2. Mechanical load of knee endoprostheses

The paper presents the numerical simulation of knee joint endoprosthesis of the human motor system, subjected to load, the aim of which was to designate stress distribution. There are two types of knee joint endoprostheses: a) W. Link sled endoprosthesis, and b) Motta-Calle total knee endoprosthesis with properly profiled motion elements (sled – polyethylene insert); both of them have surface slide.

Figure 7a shows discretized finite element model of sled endoprosthesis, and figure 7b – the one of Motta-Calle total type. The computation was carried with the ADINA System 8.1, based on the finite element method. The finite elements mesh was built of 3600 cube – shaped elements of 3D Solid type and 43 12

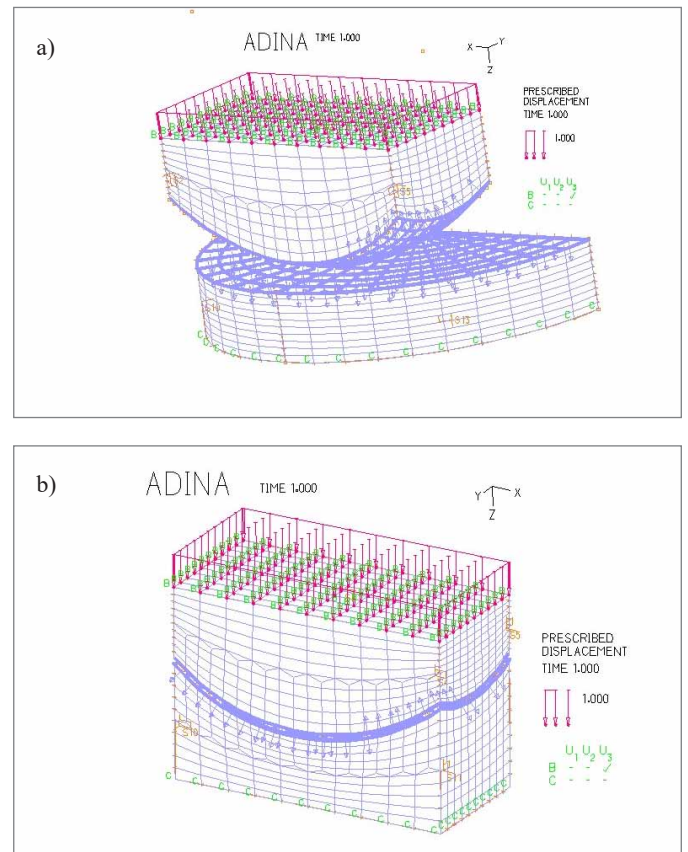

Fig. 7. Discretized finite element geometrical model of the system: metal sled – polyethylene insert, a – in the sled endoprosthesis, b – in the Motta-Calle total knee endoprosthesis

nodes. The model presented in the paper, consists of the elements respective to all parts of endoprosthesis: metal sled and UHMW polyethylene insert. Additionally, there are presented numerical calculations defining the influence of the implant geometry on the stress pattern in the contact area of the cases: sled with the cross section radius 17 mm – spherical and flat insert and sled with the cross section radius 27 mm – spherical and flat insert.

Contact stress distribution σ_{zr} [MPa], occurring in both types of inserts, are exemplary shown on Figures 8a and 8b, 9a and 9b.

Such a discrete model of sled and insert was used to simulate the performance of polyethylene inserts subjected to mechanical loads. The main purpose of the calculations was to define stress distribution on the surface of the polyethylene insert and right underneath it, where the sleds cooperate. Each pair was subjected to load $F = 1500$ N. Stress distribution in the contact area, where the sleds are pressed onto the inserts, is based on the assumptions:

- the contact area is continuous and relatively smaller than other cooperating elements,
- implemented load is close and relative to the one occurring in the real knee joint,
- both contacted parts are made of isotropic material and obey Hook's law.

Boundary conditions, settled for the calculations represent mechanical features of endoprostheses' elements as well as mechanical load distribution and values. It was assumed, that all materials used for models (medical titanium alloys, polyethylene UHMWPE) are linear-elastic and isotropic with constant mechanical features. The calculations apply to standard and simplified model of the pair subjected to load put onto the upper surface of endoprosthesis sled. The evaluation of the achieved results was based on stress pattern in the section of particular models of endoprosthesis. The calculations were carried out for partial knee joint endoprosthesis. The most significant resulted observed, are the reduced contact stresses in particular types of polyethylene inserts, due to the weakest kinematic point of endoprostheses, which is UHMWPE polyethylene. Due to large bearing surface, low values of unit pressure occur in the contact area of both elements of endoprostheses. Pressure distribution is uniform because of the surface contact. In knee joint endoprostheses consisting of spherical inserts durability time is longer, wear proceeds slower than in those with flat inserts.

The calculations prove that stress in endoprosthesis is concentrated in the polyethylene insert, right underneath the contact area of both elements, and highest stress is located

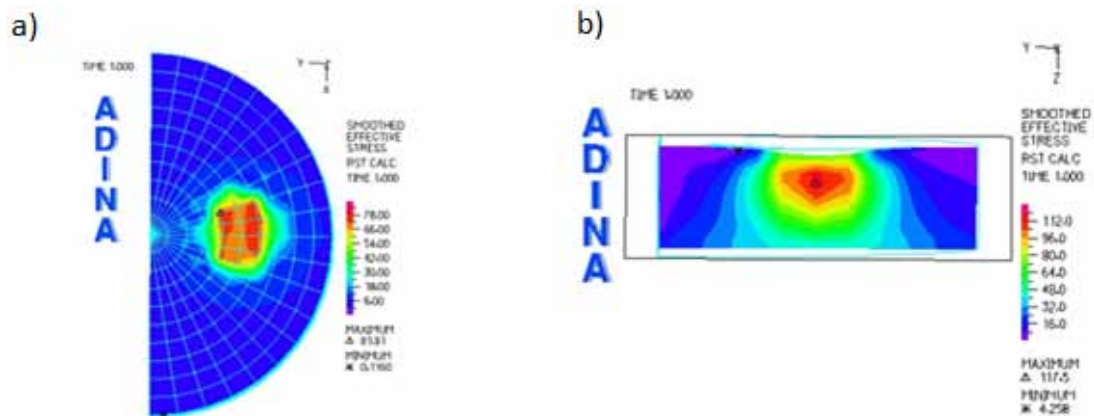

Fig. 8. Contact stresses distribution, reduced, appearing in a flat polyethylene insert, a) an overall view, b) cross-section. Polyethylene insert 8 mm wide interacting with a sled of a radius 27 mm. The load: 1500 N

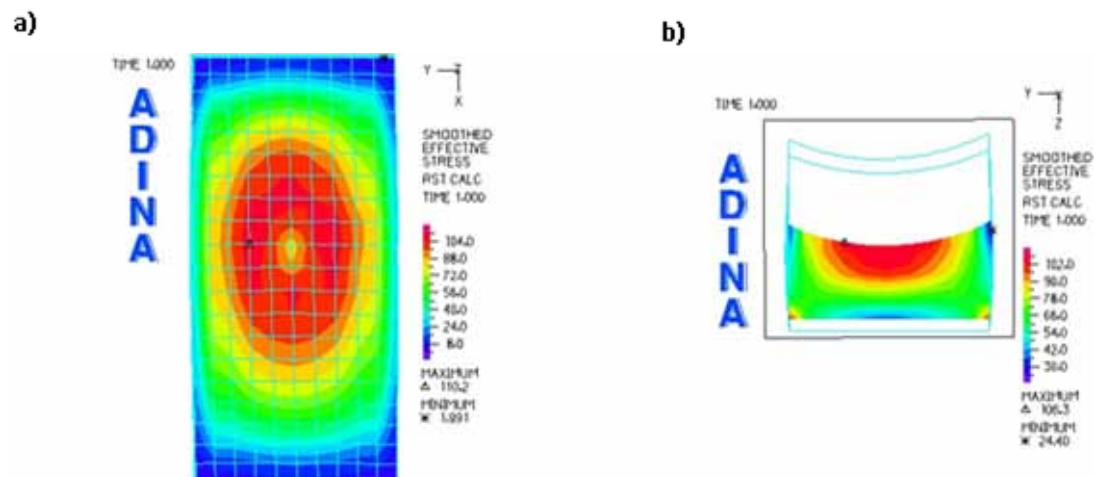

Fig. 9. Contact stresses distribution, reduced, appearing in a profile polyethylene insert [5], a) an overall view, b) cross-section. Polyethylene insert 8 mm wide interacting with a sled of a radius 27 mm. The load: 1500 N

right underneath the insert's surface. The conducted numerical calculations and analysis undoubtedly prove that the future of knee joint alloplastics belongs to a group of new materials including titanium alloys, which when appropriately selected and combined as far as mechanical features are concerned (low Young's modulus value), may significantly decrease the value of stress generated in polyethylene elements of endoprostheses.

Another important element influencing durability of endoprostheses is optimizing of the geometry of the implants both in the friction node and fixing area in the bone.

3. Experimental wear testing of friction components of the knee joint endoprostheses

An accurate technical simulation of the joints of the human motor system is impossible due to the high level of complexity of human bio-bearings. Therefore, any attempt to simulate the work of human joints, leads only to an approximation of the real human joint's movement. As a solution to the above problems, the simulator for testing durability of human knee joint endoprostheses was developed in the Institute of Metal Working and Forming, Quality Engineering and Bioengineering of the Czestochowa University of Technology. The simulator for friction and wear tests meets the following conditions:

- it models the contact geometry of a spherical surface with a plane, or a spherical surface, with an adhering surface depending on the type of knee joint endoprosthesis being examined,
- it models the kinematics of motion, characteristic of knee joint, with the omission of certain movements that occur in the real joint but are less important for the research,
- it allows to obtain the load to the friction pair of $P = (2-5) G$, where G is body weight of an average human, adopted as 70 kg.
- it allows for the measurement and recording such quantities as:
 - normal load,
 - number of loading cycles,
 - the amount of linear wear of the polyethylene insert,
- collecting the resulting wear products

The wear tests presented in this paper were conducted using the above-mentioned simulator. Figure 10 shows the front view of the station for testing of human knee joint endoprosthesis durability, whereas Fig. 11 presents the right view of this station.

The device simulates the working conditions of the bio-bearings in the musculoskeletal system during performance of squats with an additional load. The motion of lower limbs simulated in this way enables faster tribological examinations of endoprostheses. Furthermore, the movements forced by the simulator are accelerated in relation to human movements. Wear tests of these components under near-real loading conditions, is extremely time-consuming. Therefore, some acceleration of the wear process, by increasing the unit pressure of the friction pair within certain limits, was necessary. The test stand enables

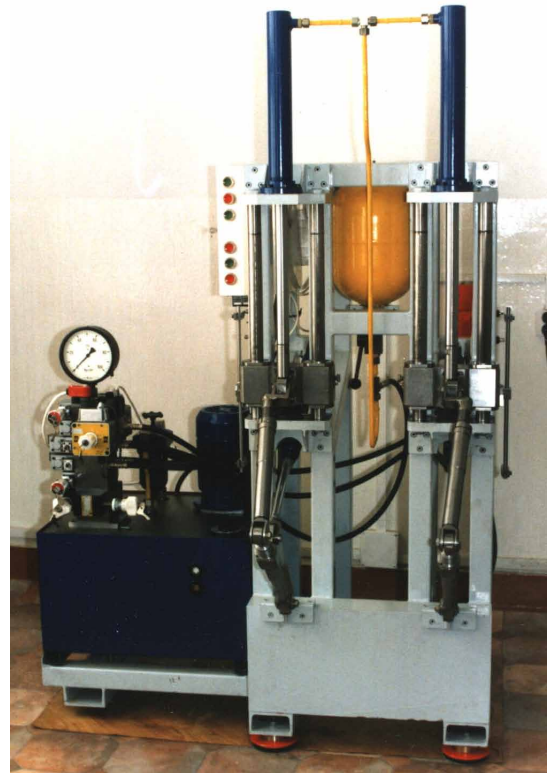

Fig. 10. Front view of the stand for testing durability of human knee joint endoprostheses

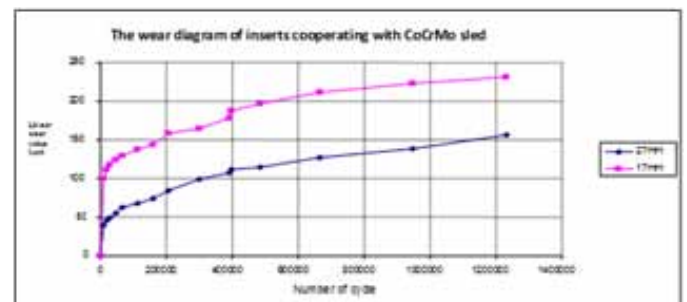

Fig. 11. Right view of the stand for testing durability of human knee joint endoprostheses

a smooth hydraulic adjustment of the load to the friction pairs and the angle of flexion of the knee joint endoprosthesis.

The basic characteristics of the test stand include:

- range of stepless adjustment of the axial load: $P = 0-3500$ N,
- maximum knee flexion angle: $\alpha = 110^\circ$,
- frequency of work of executive assemblies:
 - in a single motion system: 0.36 Hz, which corresponds with duration of the full flexion cycle of the modeled knee, $T_p = 2.8$ s,
 - in a double motion system: 0.18 Hz, which corresponds with duration of full flexion of $T_p = 5.6$ s,
 - each set of samples was subjected to 3 million loading cycles,
 - the tests were carried out without the use of lubricant,
 - normal force load $P = 1500$ N for the samples,
- power of the hydraulic drive: $N_c = 2.2$ kW.

Research carried out on the simulator, may deliver many important information about wear processes of friction elements of endoprostheses. It allows to draw the wear curves and to determine the wear intensity of tested material, in this case – polyethylene cooperating with sleds made of CoCrMo steel. The tests modeled characteristic movements of a leg. Laboratory tests used load 1500 N and with different sled curve radiuses (17 mm, 27 mm). Figure 12 presents an exemplary influence of the load of total knee endoprosthesis on average value of linear wear of polyethylene insert.

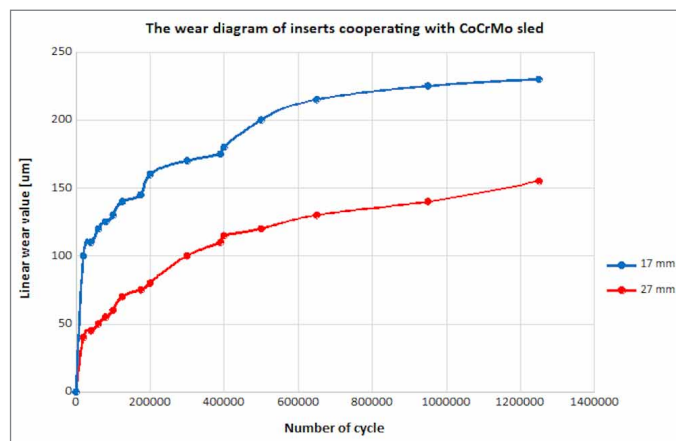

Fig. 12. Influence of load force on linear wear value of the polyethylene insert

4. Conclusion

1. The highest stresses occur for the sets: cup UHMWPE, head Al_2O_3 , stem Ti6Al4V. In all the analyzed compositions, concentration of stresses is located in the area of contact between the tapered surface of the stem with the internal part of the opening in the endoprosthesis head.
2. The highest values of the strains, which could have been foreseen, have occurred in the area of contact between the endoprosthesis cup and head. Using polyethylene head allows to counteract the transfer of stresses and strains to the deeper parts of the material, and furtherly to the pelvic bone.
3. It is reasonable continue analysis of the suggested model, and supplement it with additional elements, such as, e.g., contact with a bone.
4. The abrasive – strain processes caused appearance of many wear products, which are mainly polyethylene particles of various sizes. The process of forming the wear products occurs during the last phase of endoprosthesis operating.
5. Endoprosthesis construction, especially insert's thickness and sled's curvature radius, strongly influence the wear intensity of the polyethylene insert.
6. Polyethylene, that is actually used in medicine, has quite poor tribological features, what effects in seeking for new methods of its surface improvements.

7. Evaluation of tribological features of materials used for producing elements of endoprostheses should be based on friction – wear research conducted on simulators constructed for particular type of endoprosthesis work.

REFERENCES

- [1] C. Piconi, *Advanc. in Ceram. Biomat. Mater., Devices and Challenges Devices and Challenges*, 129-179 (2017). DOI: <https://doi.org/10.1016/B978-0-08-100881-2.00005-1>
- [2] P. Sahoo, S. Kalyan Das, J.P. Davim, *Wood. Publ. Ser. in Biomat.* 1-45 (2019). DOI: <https://doi.org/10.1016/B978-0-08-102174-3.00001-2>
- [3] Ch. Drouet, A. Leriche, S. Hampshire, *Advan. in Ceram. Biomat., Materials, Devices and Challenges* 21-82 (2017). DOI: <https://doi.org/10.1016/B978-0-08-100881-2.00002-6>
- [4] Ch. Goswami, A. Patnaik, I.K. Bhat, *Mater. Today: Proceed.* (2021). DOI: <https://doi.org/10.1016/j.matpr.2020.11.888>
- [5] D. Vogel, M. Wehmeyer, M. Keibach, *Jour. of the Mech. Beha. of Biom. Mater.* **113**, 104115 (2021). DOI: <https://doi.org/10.1016/j.jmbbm.2020.104115>
- [6] M. Olinski, A. Gronowicz, A. Handke, M. Ceccarelli, *Inter. Jour. of Appl. Mech. and Eng.* **21** (3), (2016). DOI: <https://doi.org/10.1515/ijame-2016-0037>
- [7] M. Krzywicka, J. Grudziński, J. Tatarczak, *Inż. Mater.* **37** (2), (2016). DOI: <https://doi.org/10.15199/28.2016.2.5>
- [8] A. Polyakov, V. Pakhaliuk, M. Kalinin, V. Kramar, *Proc. Engin.* 530-538 (2015). DOI: <https://doi.org/10.1016/j.proeng.2015.01.400>
- [9] A. Jahnke, C. Ulloa, J. Seegera, *Clin. Biom.* **52**, 49-56 (2018). DOI: <https://doi.org/10.1016/j.clinbiomech.2018.01.006>
- [10] X. Xu, D. Luo, Ch. Guo, Q. Rong, *Med. Engin. & Phys.* **46**, 1-11 (2017). DOI: <https://doi.org/10.1016/j.medengphy.2017.04.012>
- [11] J. Eckert, S. Jaeger, M. Klotz, M. Schwarze, R. Bitsch, *The Knee* **25** (4), 609-616 (2018). DOI: <https://doi.org/10.1016/j.knee.2018.03.013>
- [12] H. Dathe, R. Gezzi, Ch. Fiedler, *Acta of Bioengin. and Biomech.* **18**, 4, (2016). DOI: <https://doi.org/10.5277/ABB-00464-2015-03>
- [13] H. Nagerl, H. Dathe, Ch. Fiedler, *Acta of Bioengin. and Biomech* **17**, 2, (2015). DOI: <https://doi.org/10.5277/ABB-00119-2014-02>
- [14] A. Mielnińska, A. Czamara, Ł. Szuba, R. Będziński, *Acta of Bioengin. and Biomech.* **17**, 2 (2015). DOI: <https://doi.org/10.5277/ABB-00208-2014-04>
- [15] P. Melzer, M. Głowacki, J. Głowacki, J. Misterska, *Acta of Bioengin. and Biomech.* **16**, 3 (2014). DOI: <https://doi.org/10.5277/abb140313>
- [16] R. Będziński. *Biomechanical engineering*, Publishing House of the Wrocław University of Technology, Wrocław (1997).
- [17] J. Marciniak, *Biomaterials*, Publishing of Silesian University of Technology, Gliwice (2002).