

P. PRESOLY*, J. KORP**, R. SCHNEIDER***

ELECTRICAL CONDUCTIVITY AND CORRESPONDING SPECIFIC ENERGY CONSUMPTION OF NEW MgO-CONTAINING ESR-SLAGS

PRZEWODNOŚĆ ELEKTRYCZNA I ZWIĄZANE Z TYM ZUŻYCIE ENERGII NOWYCH, ZAWIERAJĄCYCH MgO ŻUŻLI DLA EŻP

Continuously increasing product requirements place constant demands on steel manufacturers with regard to innovation. Among them is the development of new Electro Slag Re-melting (ESR) slag concepts, where MgO is one of the basic components. The specific electrical conductivity of CaF₂-based MgO-containing ESR slags is determined by a specially constructed measurement cell equipped with four electrodes. The analysed slags are composed either of CaF₂-MgO with a maximum content of 15%MgO or of CaF₂- 15%CaO with stepwise substitution of CaO by MgO. The results show that the conductivity decreases with rising MgO content. In order to provide a better evaluation of the effects of adding MgO, the results are compared to the specific conductivity of pure CaF₂ and a CaF₂-CaO-Al₂O₃ standard slag. The applicability of the laboratory results in industry was verified by re-melting experiments in an electro slag re-melting furnace.

Keywords: Electro Slag Re-melting, pressurized ESR, CaF₂-based slags, CaF₂-CaO-Al₂O₃, CaF₂-CaO-MgO, CaF₂-CaO, CaF₂-MgO, specific electrical conductivity, conductivity measuring device

Ciągle zwiększające się wymagania, co do jakości produktów, przyczyniają się do stałych nacisków na producentów w zakresie stosowania innowacji. Wśród nich jest rozwój nowej koncepcji żużli EŻP, gdzie MgO jest głównym składnikiem. Przewodność właściwa żużli zawierających MgO, opartych o CaF₂, w procesie elektrożużlowego przetapiania jest określona przez specjalnie skonstruowany układ pomiarowy wyposażony w cztery elektrody. Analizowane żużle składają się albo z CaF₂-MgO z maksymalną zawartością MgO wynoszącą 15%, albo z CaF₂- 15%CaO, poprzez stopniowe zastąpienie CaO przez MgO. Wyniki wskazują, że przewodność maleje ze wzrostem zawartości MgO. W celu dostarczenia lepszej oceny efektów dodawania MgO, wyniki zostały porównane z przewodnością czystego CaF₂ i standardowych żużli CaF₂-CaO-Al₂O₃. Przydatność wyników laboratoryjnych w przemyśle została zweryfikowana przez próby przetapiania w piecu EŻP.

1. Introduction

Owing to the high demands placed on the level of cleanliness, steels with special requirements regarding their polishability, such as plastic mold steels, have extremely high standards. Only after the application of special melting practices, such as Electro-Slag-Remelting (ESR), is it possible to meet such demands on quality. ESR involves the use of mainly slags with high amounts of CaF₂. In addition to the usual procedural tasks in metallurgy, these must also meet electrical requirements [1], for only the appropriate amount of electrical resistance in the slag generates at a given current flow the amount of heat required for re-melting. The degree of

electrical resistance in the slag is, in turn, its electrical conductivity. So far, very few ESR slag systems have been analyzed in great detail, and the available data is often contradictory [2].

Determining the specific electrical conductivity of slags requires a robust measurement method and test set-up, whereby the actual measurement operation is defined by a current and voltage measurement. An overview of the various possibilities for determining conductivity by applying the method of current and voltage measurement (2 electrode measuring cells, 4 electrode measuring cells, measuring cells with both an undefined and a defined current path) is presented in [3-5].

* UNIVERSITY OF LEOBEN, LEOBEN, AUSTRIA – CHAIR OF METALLURGY

** BÖHLER EDELSTAHL GMBH & CO KG, KAPFENBERG, AUSTRIA – RESEARCH & DEVELOPMENT

*** UPPER AUSTRIAN UNIVERSITY OF APPLIED SCIENCES, WELS, AUSTRIA – DEPARTMENT FOR MATERIALS TECHNOLOGY

2. THEORY

2.1. Power consumption of Electro-Slag-Remelting

ESR is an energy-intensive steel manufacturing process with a specific power consumption in the order of approximately 1500kWh^1 [6]. From the experiments of Holzgruber [10-12], Kammel and Winterhager [13] and Machner [14] it may, moreover, be gathered that the specific power consumption is determined above all by the melting rate. Measures which serve to increase the melting rate normally bring about a reduction in the specific power consumption. The input of electrical energy, the degree of filling (ratio of diameters of electrode and ingot), the height of the slag layer and finally its resistance may be named as influencing variables. Under otherwise equal conditions, an increase in the melting rate is closely tied to an increase in the specific slag resistance, whereby the specific power consumption simultaneously decreases [9, 10, 14]. The increase in the melting rate may be explained by the resulting increased temperature of the slag layer [10]. The specific slag resistance of commonly used ESR slags of the $\text{CaF}_2\text{CaOAl}_2\text{O}_3$ system lies between $0,2$ and $0,8\Omega\text{cm}$ [7]. However, ESR is based on molten droplets of metal that fall from the electrode to form an emulsion consisting of metal and slag, which exhibits a considerably lower level of resistance, owing to the highly conductive metal, than the slag itself.

2.2. ESR slags with MgO: CaF_2MgO - and $\text{CaF}_2\text{CaOMgO}$ slags

Along with the natural raw materials CaF_2 and CaO , MgO is also incorporated into the slag [17, 18]. Therefore it can be found, albeit only in small amounts, in all ESR slags [19]. In addition to the main components of ESR slags, CaF_2 , CaO and Al_2O_3 , in certain cases MgO is also deliberately added. One such case is represented by the binary slag of CaF_2 and MgO , whereby CaO and Al_2O_3 are completely replaced for the application of ESR. Back when the industrial application of the ESR process was still young, such slags, those with $80\%\text{CaF}_2$ and $20\%\text{MgO}$ (ANF-9) for instance, were often used as desulfurization slags in the manufacture of hydrogen sensitive steels, because they posed a viable alternative to the hygroscopic CaF_2CaO slags. With this configuration, similar to the CaF_2CaO system, the demand for low melting temperatures is quite practicable, as shown in the phase diagram (Fig. 1).

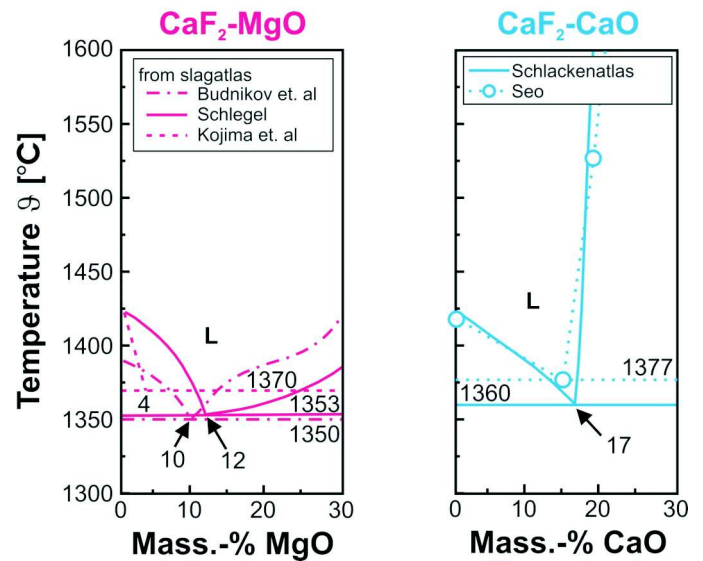

Fig. 1. - CaF_2 rich corner of a phase diagram from CaF_2MgO and CaF_2CaO systems (Source: Schlackenatlas [2], Seo [20])

During the investigation of $\text{CaF}_2\text{-MgO}$ under uncontrolled conditions (i.e. contact with humidified air) CaO is also created by the reaction $\text{CaF}_2 + \text{H}_2\text{O} = \text{CaO} + 2\text{HF}$. This leads to the ternary system $\text{CaF}_2\text{CaOMgO}$, which takes on greater importance in slag systems on the whole. The melting temperatures shown in the phase diagram play an important role in choosing the right ESR slag, as only those slag mixtures, whose melting point lie approximately 100°C under the melting point of the alloy to be melted, come into question [21]. Unlike $\text{CaF}_2\text{CaOAl}_2\text{O}_3$ systems, such phase diagrams of the components CaF_2 , CaO and MgO have up to now seldom been the subject of dedicated scientific study. Here we distinguish the work of Schlegel [22], who made the phase diagram shown in Fig. 4 (chart on the right). It consists of the eutectic boundary systems CaF_2CaO , CaF_2MgO and CaOMgO , which form a ternary eutectic at $71\%\text{CaF}_2$, $19\%\text{CaO}$, $10\%\text{MgO}$ and 1343°C .

Mitchell describes in [8], that MgO in the slag can produce small amounts of Mg vapor on the surface of the electrodes during the cathode cycle. Consequently, favorable conditions for periodic, stable arc loads are created, whereby the ESR process becomes unstable. Therefore it is critical to monitor slags with MgO -concentrations of approximately 10% [8].

3. EXECUTION OF LABORATORY TESTS

The specific electric conductivity is determined by the measuring apparatus shown in Fig. 2 and described in [5] according to 4 electrode measurement method. The calibration of the measuring cell was done using a $0,1\text{molar}$ KCl solution ($\kappa_{20^\circ\text{C}}=0,01167\Omega^{-1}\text{cm}^{-1}$ [23]) under test conditions similar to those used when measuring the slag. After calibration the slag was heated in a gas-tight Tammann furnace in purified Ar to a temperature just over 1600°C , and the specific electric conductivity was measured.

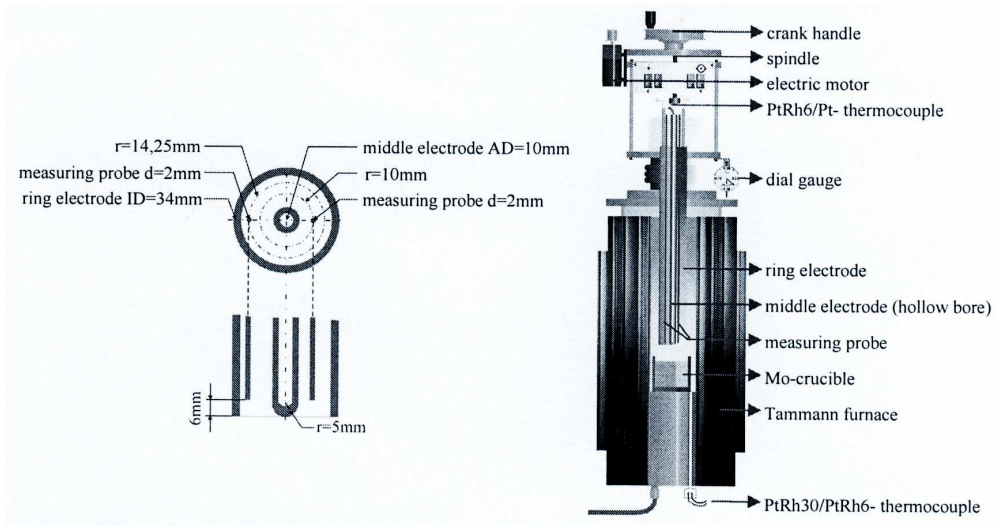

Fig. 2. Construction of the conductivity measuring device

TABLE 1

Composition of slag melts

No.:	Composition in Mass.-%																		
	1	2	3	4	5	6	7	8	9	10	11	12	13	14	15	16	17	18	19
		I	II									IV	V						III
CaF₂	100	97	34	95	90	85	95	90	85	80	90	85	80	75	85	80	75	70	75
CaO	-	-	30	-	-	-	5	5	5	5	10	10	10	10	15	15	15	15	20
MgO	-	-	3	5	10	15	-	5	10	15	-	5	10	15	-	5	10	15	5
Al₂O₃	-	3	33	-	-	-	-	-	-	-	-	-	-	-	-	-	-	-	-

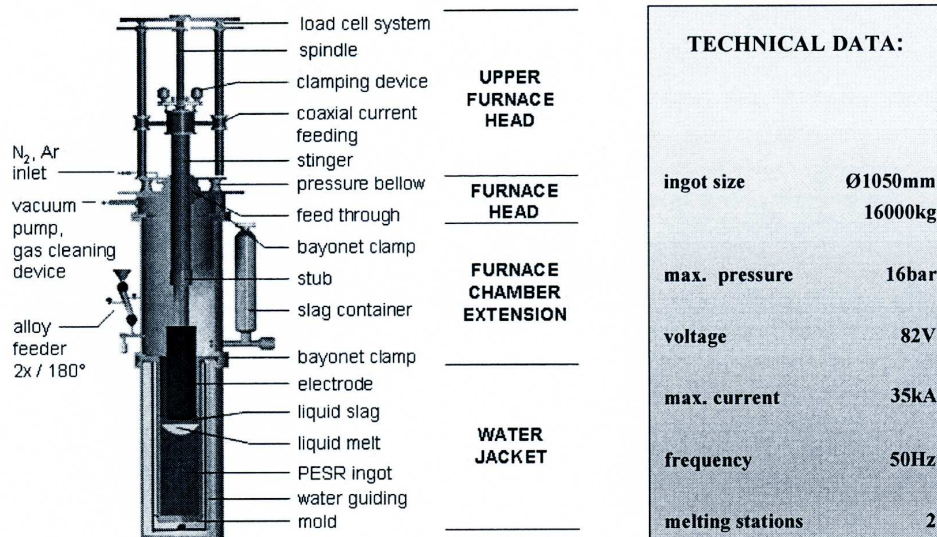

Fig. 3. Construction of the shielding gas/pressurized ESR plant of Böhler Edelstahl GmbH & Co KG with a maximum pressure up to 16bar

The studied slags (Table 1) were mixed from pure powdered substances (purity > 99%) from SIGMA ALDRICH AG to form a total weight of 210g.

4. EXECUTION OF FIELD TESTS

4.1. Layout of a pressurized ESR plant

The re-melting tests were carried out on the shielding gas/pressurized ESR plant shown in Fig. 3. As called for, the plant may be operated in either shielding gas/high-pressure mode or in shielding gas mode alone. The type of operation depends on the type of steel being produced. As a rule nitrogen steel alloys and steels with high requirements on cleanliness, corrosion resistance, polishability and toughness are manufactured in high-pressure ESR plants.

4.2. Steel and slag composition in the field test

In the field tests the plastic mold steel Böhler M333 ISOPLAST, a corrosion-resistant, martensitic Cr steel, was re-melted. This steel is characterized above all by its outstanding toughness at a typical hardness level of 50-54HRC. Its strong corrosion-resistance is based on a significant nitrogen alloying content. Its excellent polishability results from an extremely homogenous microstructure combined with the least possible number of non-metallic inclusions. This steel also possesses a better thermal conductivity than standard grades allowing a reduction in cycle time during plastic processing. The typical composition of M333 ISOPLAST is 0.28%C,

0.30%Si, 0.30%Mn, 13.5%Cr and 0.1%N [24]. The tests employed electrodes with a cross-section of $\varnothing 260\text{mm}$ and an ingot mold of $\varnothing 400\text{mm}$, as well as an ingot weight of approximately 2t. The amount of slag used lay just under 60kg.

In the field trials only those slag designs were tested, the conductivity characteristics of which had been previously investigated in the laboratory (I – V in Table 3). The designs of the laboratory and operational slags are in fact essentially identical, however, slight differences in the composition of the slags arise, owing to variations in the purity of the components. While the laboratory slags were comprised of chemically pure substances, the individual components of the operational slags were merely technically pure.

The compositions I and II (Fig. 4, left chart) represent two extreme cases of slags, where due to the good conductivity of CaF_2 and their carefully-chosen composition, on the one hand a very high (slag I) and on the other hand a very low (slag II) power requirement was to be expected. Both slags served as a standard gauge for the assessment of the alternative $\text{CaF}_2\text{CaOMgO}$ slag designs which followed.

The slags III – V of the $\text{CaF}_2\text{CaOMgO}$ system are located in the CaF_2 rich corner near the ternary eutectics (Fig. 4, right chart). High concentrations of MgO far outside of this area were avoided, so as not to risk the chance of periodic, stable arc loads [8] and the damage to the ingot mold which these can cause. Additionally, high concentrations of CaO were also consciously avoided, as these compositions lie within a high-melting area, where the first solid CaO precipitation is also to be expected.

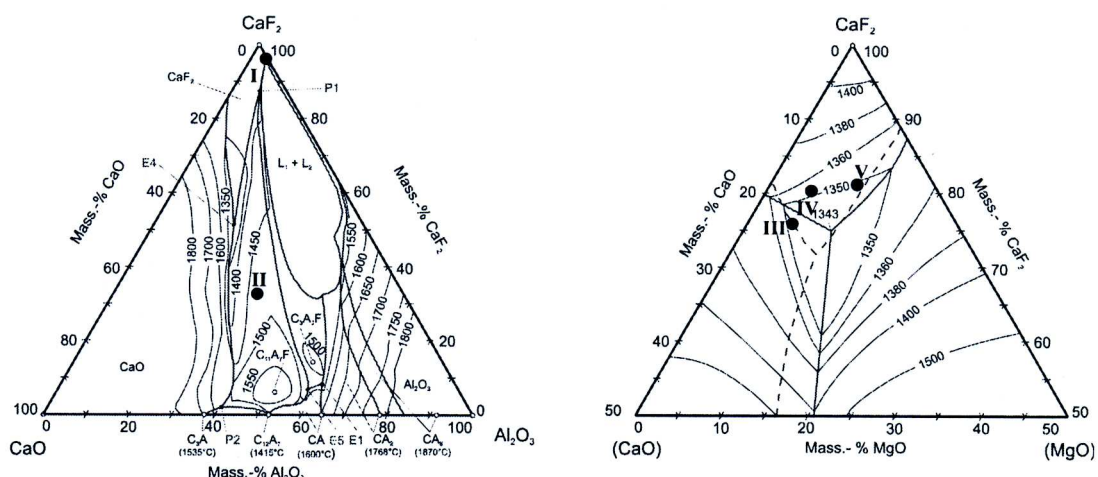

Fig. 4. Position of the slag compositions in the corresponding phase diagram of the $\text{CaF}_2\text{CaOAl}_2\text{O}_3$ system according to Chatterjee and Zhmoydin [25] as well as the $\text{CaF}_2\text{CaOMgO}$ system according to Schlegel [22]

5. RESULTS AND DISCUSSION

5.1. Results of the laboratory tests on $\text{CaF}_2\text{CaOMgO}$ slags

In Fig. 5 the specific electric conductivity for the $\text{CaF}_2\text{CaOMgO}$ system is shown against the CaO and MgO concentrations in Mass.-%. The uppermost lines of both diagrams represent the results of the pure binary system CaF_2CaO (Fig. 5, left) and CaF_2MgO (Fig. 5, right). Without the addition of MgO the conductivity at low concentrations of CaO remains practically constant and begins to sink continuously with increasing concentrations of CaO. These results for the CaF_2CaO system are well within the framework of measurement uncertainty in good correlation with the trustworthy values given by Mitchell [26] and Ogino [27], whereby the results from Ogino et al. lie somewhat above and, in the case of Mitchell, somewhat below these values. Published values on the conductivity of CaO concentrations considerably higher than 15% are not directly comparable due to the expected precipitation of solid CaO (Fig. 1, right).

A purely binary CaF_2MgO system shows similar characteristics, whereby a reduction in conductivity with low concentrations of MgO is distinctly detectable and the reduction occurs more noticeably. With similar slag compositions there have been but few measurements with tried and proven measurement technologies and these have predominantly dealt with MgO concentrations of over 15%. Only the values provided by Ogino et al.

[27] pertain to the same concentration area and strongly correlate with the aforementioned results.

At CaO and MgO concentrations around 15% the purely binary systems displayed greater variance in the test results, which could afterwards be attributed to a failure to thoroughly mix the substances before the melting process begins. For concentrations higher than 15% the use of pre-molten slags instead of pure, powdered components is therefore highly recommended.

If one considers the combined effect of both oxides it can be shown that within the concentrations tested, up to a maximum of 15%CaO and 15%MgO, both additives contribute to a decrease in conductivity. In the binary systems CaF_2CaO and CaF_2MgO conductivity decreases minimally at the outset with the addition of the respective oxide. This reduction increases considerably - as previously mentioned - at higher concentrations. In ternary systems, however, the greatest decrease is mostly observed within the first 10%. Afterwards the trend appears to be considerably flatter. This correlation is clearly pronounced at higher CaO concentrations in slags containing MgO.

If one transforms the results from Fig. 5 into iso-conductivity lines for the CaF_2 corner of the $\text{CaF}_2\text{-CaOMgO}$ system, the result yields a better overview of the ratios. The line progressions of the iso-conductivity lines in Fig. 6 are roughly parallel, whereby this mirrors the trend of the binary system comparisons, in that MgO shows itself to be the more effective of the two additives and the effect of reduced conductivity at increasing concentrations of CaO decreases considerably.

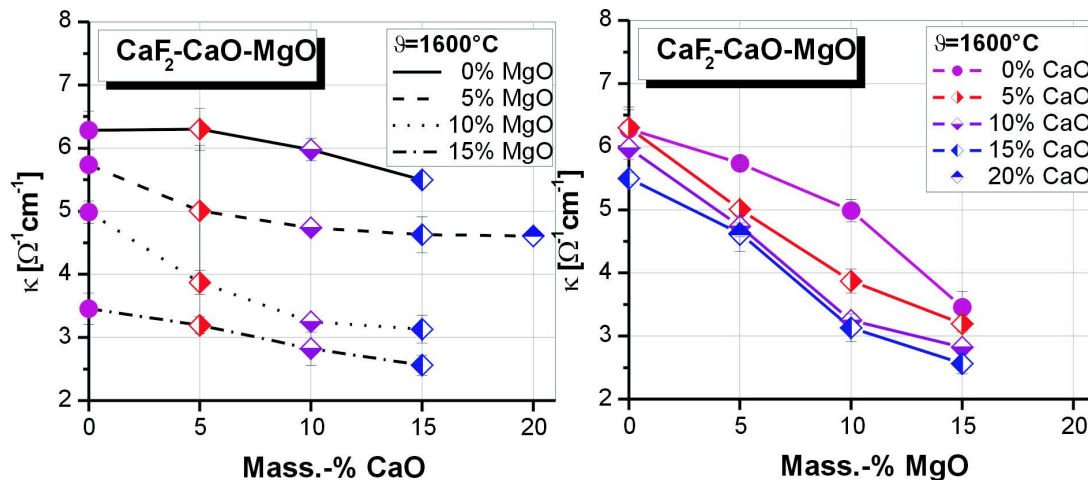

Fig. 5. Specific electric conductivity of CaF_2 CaO MgO slags against CaO and MgO concentrations at 1600°C

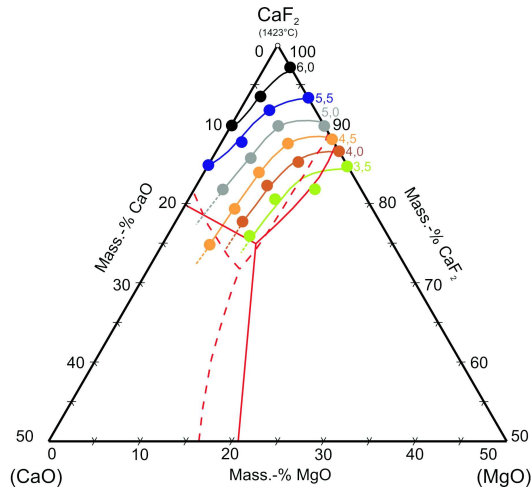

Fig. 6. Iso-conductivity lines in the CaF_2 rich area of CaF_2 - CaO - MgO systems at 1600°C

Drawing a comparison with the results of various other authors is not possible here, because the literature contains no record of a systematic investigation for the determination of the specific electric conductivity of these slag compositions. The form of the iso-conductivity lines are, however, in principle quite similar to the better documented and well-known CaF_2 - CaOAl_2O_3 system [2].

5.2. Transferability of laboratory tests to operational conditions in ESR

The specific electric conductivity determined in laboratory tests primarily mirrors the specific power consumption of the field tests. This becomes apparent when the specific electric conductivity and the specific power consumption are brought into relation with one another. To do this, the specific power consumption of the field tests with technically pure slags is shown in Fig. 7 over the specific electric conductivity from the laboratory tests with chemically pure slags. The shaded area between these value pairs illustrates the trend of coherences.

As the results in Fig. 7 show, the high specific electric conductivity of a slag is an indicator for a high rate of power consumption when re-melting, and vice versa. This specific correlation of results exist, however, only under the conditions stated here, and may only be applied to other operational parameters with extreme reservation. Particularly, the following aspects should be taken into consideration:

With regard to the specific electric conductivity there exists a basic difference between the correlations drawn between laboratory and field conditions. Variances result from the operational frequency of 1000Hz on the laboratory plant and 50Hz on the field test plant. The conductivity of the slag is indeed the same in both

cases, however, the significance of the frequency effect is varied. An additional aspect of the aforementioned differences is that in the laboratory the measurement medium represents only the slag, whereas in the field the slag is permanently interspersed with droplets of metal, whereby the conductivity of these metal/slag emulsion increases considerably due to the proportion of metal [28]. Further variances exist in temperature distribution of the slag and the purity of the slag components. Regarding the specific electric conductivity, it is also to be observed that the absolute specific electric conductivity is not as interesting as its relative conductivity behavior when designing new ESR slags. The laboratory tests also represent a practical aid to making decisions when choosing new ESR slags.

With regard to the power consumption determined in field tests, it should be taken into consideration that this is influenced not only by the conductivity of the slag, but also by other factors, such as the thermal conductivity of the slag and the heat transfer coefficients which are determined by the thickness of the slag film.

The comparability of the specific power consumption rates from these tests with the results of other works is made more difficult not only by the aforementioned factors, but also by the seldomly concurrent metallurgical parameters of the amount of slag [15], the degree of filling [9] and the composition of the re-melt material. From the point of view of plant-engineering there exist additional influences on power consumption related to the type of current being supplied (high current wiring or high current raiting), whereby the high current raiting displays a smaller amount of reactive power and therefore less power consumption [29]. It would therefore be impossible to completely fulfill each and every criteria for comparability.

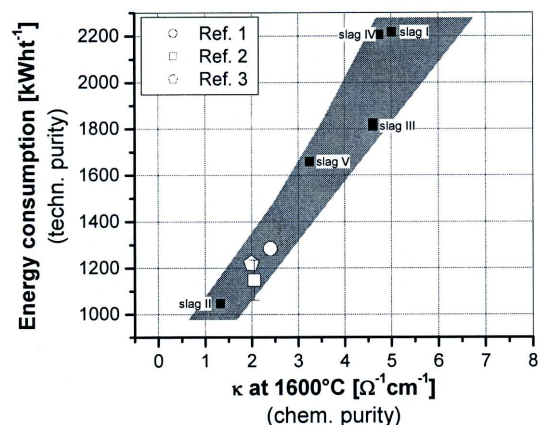

Fig. 7. Lined up for comparison are the ascertained correlation areas between specific electric conductivity and specific power consumption with results from literature (Ref 1: Schlackenatlas [2] – Zhengbang et al. [9]; Ref. 2: Schlackenatlas [2] – Everson [30] Ref. 3: Schlackenatlas [2] – El Gammal et al. [15])

Irrespective thereof, the ascertained comparison values fit nicely in the correlation areas shown in Fig. 7, which are at least corroborated at a specific electric conductivity up to $3\Omega^{-1}\text{cm}^{-1}$. For slag compositions with higher conductivity levels there is no data in the literature gathered regarding power consumption, which is why no absolute comparison could be made for this particular area of interest.

6. SUMMARY

The aim of this work was to test the effects of the basic slag components of CaO and MgO on the electric conductivity of CaF_2 . To carry out these tests a conductivity measuring device based on the 4 electrode measuring method was created for an existing Tammann furnace. In field tests on a high-pressure ESR plant, the transferability of the conductivity measurements on power consumption was ascertained, and the effect of the individual slag components verified with operational benchmarks.

These tests yielded the following results:

- In CaF_2 binary systems the addition of CaO and MgO decreases the specific electric conductivity of CaF_2 . In such cases MgO has a considerably stronger effect than CaO.
- In multi-component systems the effect of the individual components adds up, particularly with low concentrations, which cause the conductivity to drop off more strongly.
- The additionally conducted field tests resulted in the finding that the ascertained conductivity values of $\text{CaF}_2\text{CaOMgO}$ slags correlate very well with the specific power consumption.
- A reduction in power consumption through the use of $\text{CaF}_2\text{CaOMgO}$ as opposed to pure CaF_2 , although possible, does not in this regard represent a comparable alternative to commonly used standard slags of the $\text{CaF}_2\text{CaOAl}_2\text{O}_3$ system.

For that reason a first, fundamental assessment of this type of slag system took place, and was tested in consideration of its operational usability.

REFERENCES

- [1] A. Mitchell, Slag Functions in the ESR Process, Proceedings of the 2005 International Symposium on Liquid Metal Processing and Casting, p.195-200 Santa Fe (2005).
- [2] Schlackenatlas, Verlag Stahleisen G.m.b.H. Düsseldorf, (1995).
- [3] M.Hajduk, T. El Gammal, Schriftumszusammenstellung von Leitfähigkeitsmessungen an CaF_2 -haltigen Schlackenschmelzen, Stahl und Eisen **99**, p.113-116 (1979).
- [4] S. L. Schiefelbein, A New Technique to Measure the Electrical Properties of Molten Oxides, Dissertation, Massachusetts Institute of Technology (1996).
- [5] J. Korp, R. Rabitsch, R. Schneider, W. Krieger, Experimentelle Bestimmung der spezifischen elektrischen Leitfähigkeit hoch CaF_2 haltiger Schlacken, p.184-189 BHM (2006).
- [6] B. I. Medovar, State of the Art and Prospects of Electroslag Technology Development, Proceedings of the 9th International Vacuum Metallurgy Conference on Special Melting, p.566-571 San Diego (1988).
- [7] G. Hoyle, Electroslag Processes Principles and Practice, Applied Science Publisher, London and New York, (1983).
- [8] A. Mitchell, The use of rare-earth oxides in electroslag remelting, Report to: The Molybdenum Corporation of America, (1976).
- [9] L. Zhengbang, Z. Jiawen, Influence of slag composition and fill ratio on power consumption of electroslag remelting, Proceedings of the 7th International Conference on Vacuum Metallurgy, p.1486-1494 Tokyo (1982).
- [10] W. Holzgruber, Das Elektroschlacke Umschmelzverfahren, Dissertation, Montanuniversität Leoben, (1967).
- [11] W. Holzgruber, E. Plöckinger, Das Elektroschlacke Umschmelzen- ein neues Verfahren zur Verbesserung der Qualität von Edelstählen, BHM **113**, p.83-93 (1968).
- [12] W. Holzgruber, E. Plöckinger, Metallurgische und verfahrenstechnische Grundlagen des Elektroschlacke Umschmelzens von Stahl, Stahl und Eisen **88**, 638-648 (1968).
- [13] R. Kammel, H. Winterhager, Raffination von Metallen durch Elektroschlacke- Umschmelzen, Erzmetall **21**, 399-448 (1968).
- [14] P. Machner, Die Hauptparameter des ESU-Prozesses und deren Einfluss auf den Blockaufbau und die Wirtschaftlichkeit des Verfahrens, BHM **118**, p.365-372 (1973).
- [15] T. El Gammal, I. von Hagen, Grundlagen der Raffination eines einfachen Baustahles nach dem Elektroschlacke Umschmelzverfahren, Forschungsbericht des Landes Nordrhein-Westfalen Nr. 2565, (1976).
- [16] P. Dewson, R. Schlatter, Process and Product Characteristics of DC Electroslag Remelting of Alloy Steels, Proceedings of the 5th International Symposium on Electroslag and other Special Melting Technologies, p.91-114 Pittsburgh (1974).
- [17] B. Korousic, Technologische Merkmale der ESU-Schlacken - Teil 1: Chemische Heterogenität der in einem 10t Elektroofen erzeugten ESU-Schlacken, p.764-769 Radex-Rundschau (1976).
- [18] B. Korousic, V. Oster, Technologische Merkmale der ESU-Schlacken – Teil 2: Mineralogische Anal-

- yse von ESU-Schlacken, p.803-813 Radex-Rundschau (1976).
- [19] Wacker, Vorgeschmolzene Schlacken – Die Erfolgskomponente im Elektroschlacke Umschmelzverfahren (ESU), in Werkstoffdatenblatt (2007).
- [20] W.-G. Seo, D. Zhou, F. Tsukihashi, Calculation of thermodynamic Properties and Phase Diagrams for the CaOCaF₂, BaOCaO and BaOCaF₂ Systems by Molecular Dynamics Simulation, Materials Transactions **46**, p.643-650 (2005).
- [21] A. Mitchell, The Chemistry of ESR Slags, Canadian Metallurgical Quarterly **20**, p.101-112 (1981).
- [22] E. Schlegel, Das System CaOMgOCaF₂, Silikatechnik **20**, p.93-95 (1969).
- [23] F. W. Küster, Rechentafeln für die Chemische Analytik, Berlin NewYork, (1985).
- [24] R. Schneider, R. Pierer, K. Sammt, W. Schützenhöfer, Heat Treatment and behaviour of new corrosion resistant plastic mold steel with regard to dimensional change, Proceedings of the 4th International Conference on Quenching and the Control of Distortion, Beijing, p.357-362 (2003).
- [25] A. K. Chatterjee, G. I. Zhmoydin, The Phase Equilibrium Diagram of the System CaOAl₂O₃CaF₂, Journal of Materials Science **7**, p.93-97 (1972).
- [26] A. Mitchell, J. Cameron, The Electrical Conductivity of Some Liquids in the System CaF₂-CaOAl₂O₃, Metallurgical Transactions **2**, p.3361-3366 (1971).
- [27] K. Ogino, S. Hara, H. Hashimoto, Study of the Conduction Mechanism of Molten Fluxes for Electroslag Remelting, Tetsu to Hagane **64**, p.48-55 (1978).
- [28] A. D. Ryabtsev, et al., About Electrical Conductivity of Fluxes of CaF₂-Ca System, Advances in Electrometallurgy **1**, p.2-3 (2003).
- [29] A. soScheriau, H. Holzgruber, Developments and Operational Experiences of Three Most Modern ESR-furnaces, Proceedings of the 2005 International Symposium on Liquid Metal Processing and Casting, Santa Fe, p.121-129 (2005).
- [30] H. Everson, Remelted steels, process, product and properties, Steel Times **221**, p.427-429 (1993).