

J. SZAJNAR*, M. STAWARZ*, T. WRÓBEL*, W. SEBZDA*

INFLUENCE OF SELECTED PARAMETERS OF CONTINUOUS CASTING IN THE ELECTROMAGNETIC FIELD ON THE DISTRIBUTION OF GRAPHITE AND PROPERTIES OF GREY CAST IRON

WPLYW WYBRANYCH PARAMETRÓW ODLEWANIA CIĄGŁEGO W POLU ELEKTROMAGNETYCZNYM NA ROZKŁAD GRAFITU I WŁAŚCIWOŚCI ŻELIWA SZAREGO

In paper problem concerning modification of grey cast iron EN-GJL-200 Grade, which is realized mainly by intensification of liquid metal movement in horizontal continuous casting mould containing electromagnetic stirrer is presented. The range of studies contains influence of electromagnetic field on morphology of graphite and usable properties i.e. tensile strength, hardness and machinability. Moreover the influence of velocity of ingot pulling on microstructure was analyzed. The results of studies and their analysis show possibility of improvement in quality of grey cast iron continuous ingot firstly in result of elimination of hard spots in structure by properly selection of velocity of ingot pulling and second in result of unification of size, shape and distribution of flake graphite by application of electromagnetic field.

Keywords: continuous casting; ingot; grey cast iron; graphite; electromagnetic field

W pracy przedstawiono problematykę modyfikacji żeliwa szarego gatunku EN-GJL-200 realizowanej głównie poprzez intensyfikację ruchu ciekłego metalu w krystalizatorze zawierającym mieszadło elektromagnetyczne w procesie poziomego odlewania ciągłego. Zakres badań obejmował badania wpływu pola elektromagnetycznego na morfologię grafitu oraz właściwości użytkowe tj. wytrzymałości na rozciąganie, twardości oraz skrawalność. Ponadto analizowano wpływ prędkości wyciągania wlewka na jego mikrostrukturę. Wyniki badań oraz ich analiza pokazały, że istnieje możliwość poprawy jakości wlewka ciągłego z żeliwa szarego po pierwsze w wyniku wyeliminowania ze mikrostruktury zabieleni poprzez właściwie dobraną prędkości wyciągania oraz po drugie w wyniku ujednorodnienia wielkości, kształtu oraz rozmieszczenia grafitu płatkowego poprzez zastosowanie oddziaływania pola elektromagnetycznego.

1. Introduction

Forced convection of liquid metal in the traditional mould or in the continuous casting mould has a significant influence on the crystallization process of castings. For many years, the device whose main purpose is to generate movement of the liquid metal were used. First, they were the typical mechanical or electromagnetic stirrers, used to unification the liquid metal in e.g. maintaining furnace or faster melting of alloying additives. Developments in the field of refractory materials and electrical engineering and, above all, recognize the positive effect of forced convection on the crystallization process of casting structure has brought a wider use of the magnetohydrodynamic (MHD) devices in the seventies of the last century. Generally in foundry practice horizontal or vertical electromagnetic field generated by electromagnetic stirrers which principle of operation based on construction of induction coil is used (Fig.1) [1].

So far, the influence of electromagnetic fields in order to unification the microstructure has been successfully applied in the casting of ferrous-carbon alloys [1-5] and non-ferrous metals [6-11]. In contrast, the paper [12] present the possibility

of influence of the electromagnetic stirring on the solidifying metal to unification the microstructure of grey cast iron. It is anticipated that this procedure will allow to obtain more favorable properties as compared to grey cast iron without forced convection at the time of its solidification in continuous casting mould.

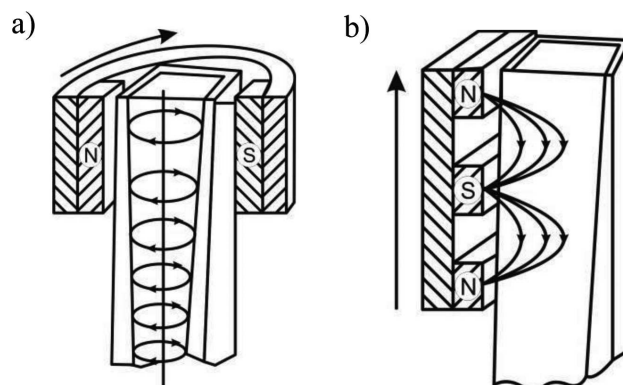

Fig. 1. Scheme of an electromagnetic stirrer (induction coil) forcing horizontal (a) and vertical (b) movement of liquid metal [1]

Therefore the aim of paper is to present of improvement in quality of grey cast iron continuous ingot by properly selection of velocity of ingot pulling and by application of electromagnetic field.

2. The range of studies

To studies of grey cast iron ingots φ 20 mm diameter were used laboratory stand of horizontal continuous casting, which is placed in Foundry Department of Silesian University of Technology. The stand consists of three main parts i.e. melting part (Fig. 2a) consisting of a crucible induction furnace with maximum capacity of 80 kg, casting part (Fig. 2b) consisting of a 20 mm diameter graphite continuous casting mould and water cooling radiator made of chromium-nickel austenitic steel and operating in a closed circuit, equipped with water flow controls and temperature measurement system and a electromagnetic field inductor (stirrer) placed in the chamber between radiator and cover. The last part is automatic pulling machine of continuous ingot (Fig. 1c).

The electromagnetic stirrer placed in water-cooled continuous casting mould generates rotate electromagnetic field (Fig. 1a). Application of this type of electromagnetic field makes possible obtainment of forced convection of liquid metal in perpendicular plane to ingot axis.

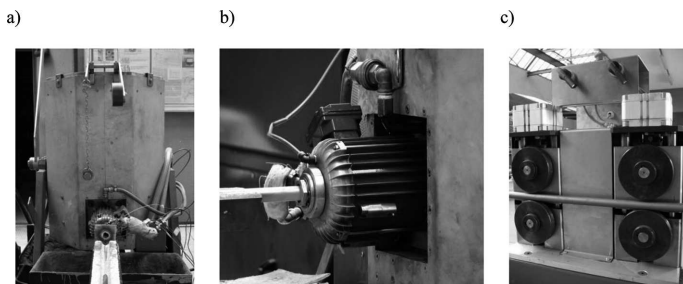

Fig. 2. Laboratory stand of horizontal continuous casting in the Foundry Department of the Silesian University of Technology: a – induction furnace, b – continuous casting mould, c – pulling machine

To fundamental steering work parameters of electromagnetic stirrer with a maximum power 3kW belong current intensity $I = 10$ A feeding the stirrer, which corresponds to value of magnetic induction $B = 60$ mT inside of continuous casting mould, frequency of supply current $f = 25 \div 100$ Hz, which at constant value of current intensity makes possible regulation of force, which generating the movement of liquid metal and in result of this the velocity of liquid metal movement in continuous casting mould.

To residual parameters of studied horizontal continuous casting process belong overheating temperature of liquid metal in furnace $T = 1450^\circ\text{C}$, temperature of cooling water in continuous casting mould $T_w = 70^\circ\text{C}$ at flow rate $Q_w = 2,5 \div 5$ l/min in dependence of velocity of ingot pulling $V = 200 \div 700$ mm/min at algorithm of ingot movement: forward 5 s, stop 0.5 s, backward 0.5 s and so on. The minimum and maximum velocity of ingot pulling depends on the position of the solid/liquid front. An decrease of velocity of ingot pulling below 200 mm/min results in breaking of ingot by shifting of the crystallization front on entry of the continuous casting mould. Whereas an increase of velocity of ingot pulling over

the 700 mm/min results in shifting of the crystallization front on outside the continuous casting mould. Then liquid metal pours on the outside of continuous casting mould. The last parameter is temperature of ingot after leaving the continuous casting mould $T_0 = 300 \div 1000^\circ\text{C}$, which value depend on all presented parameters. This temperature is measured directly in casting process with use of pyrometer.

Morphology of flake graphite in structure of studied grey cast iron was evaluated in bases of metallographic microscopic examinations on scanning electron microscope Inspect F. Observation of microstructure was made on non-etch micro-sections in fields: on periphery, half of radius and in axis of ingot.

In range of studies of usable properties were made measurements of hardness on cross-section of ingots with use of Brinell method and designation of machinability with use of Keep-Bauer method. To machinability studies was used cutting tools (borer φ 5 mm diameter) with identical contour and angles, which were burdened of force 350 N. Rotational speed of tools was 360 turns on minute and height of samples was 20 mm. In each investigated ingots were bored 3 test-hole and time of boring was measured. Moreover on the basis of tensile test was evaluated tensile strength UTS of studied continuous ingots.

3. The results of studies

On Figure 3 the influence of velocity of ingot pulling on the quantity of hard spots in microstructure of cast iron is shown. It was found that with an increase in velocity of ingot pulling the amount of cementite in the structure of cast iron is decreasing (Fig. 4). The most advantageous velocity of ingot pulling $V = 700$ mm/min provides low cooling rate of cast iron, because of its short stay time in area of the water-cooled continuous casting mould. Then the temperature of ingot after leaving the continuous casting mould is about $T_0 = 1000^\circ\text{C}$, and a large part of the process of shaping the final microstructure of the cast iron takes place during cooling in air.

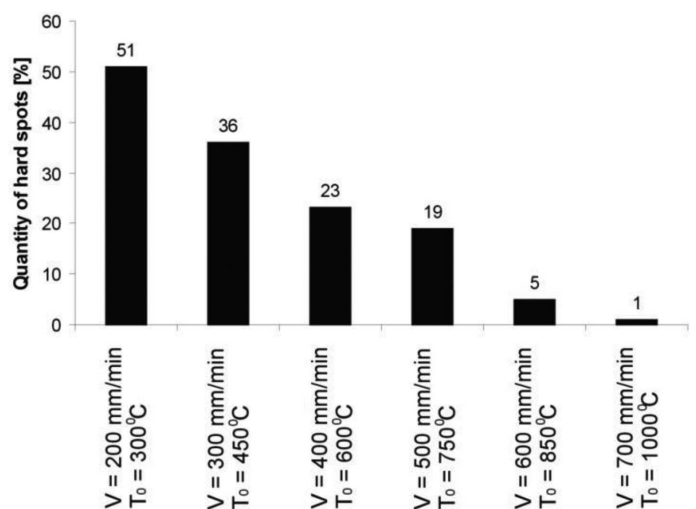

Fig. 3. Influence of the velocity of ingot pulling V on percentage quantity of hard spots in microstructure of grey cast iron (at definite value of the temperature of ingot after leaving the continuous casting mould T_0)

In Table 1 are presented the results of metallographic microscopic examinations of ingots, which were cast at velocity of pulling $V = 700$ mm/min. As a result of obtaining a small amount of cementite and the irregular shape and distribution of graphite in the microstructure there is a big gradient of hardness in cross-section of the ingot (Fig. 5), which consequently caused a deterioration in machinability (Fig. 6).

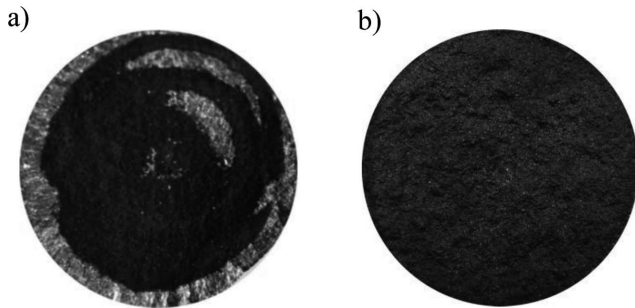

Fig. 4. Macrostructure of grey cast iron fracture at velocity of ingot pulling and temperature of ingot after leaving the continuous casting mould: $V = 200$ mm/min and $T_0 = 300^\circ\text{C}$ (a), $V = 700$ mm/min and $T_0 = 1000^\circ\text{C}$ (b)

By contrast, the use of electromagnetic field forced convection of the solidifying metal result in increases of the unification of flake graphite morphology. This phenomenon has been advanced especially by the influence of the electromagnetic field created in the stirrer powered with a frequency of 50 Hz. Whereas the influence of the application of rotate electromagnetic field powered with the frequency different from the power network, i.e. 25, 75 and 100 Hz promotes partial unification of the graphite morphology, only in fields from about half of radius of ingot to its center. On the periphery

of the ingot, occur undesirable in the point of view of usable properties i.e. machinability, short and compacted graphite, often with a different shape then the flake graphite.

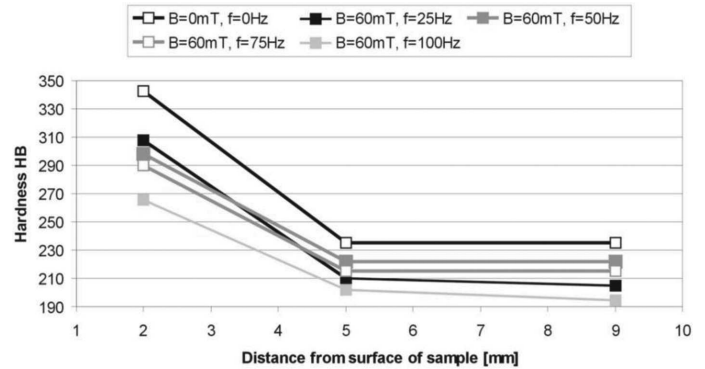

Fig. 5. Influence of the electromagnetic field on hardness distribution on cross-section of grey cast iron continuous ingot

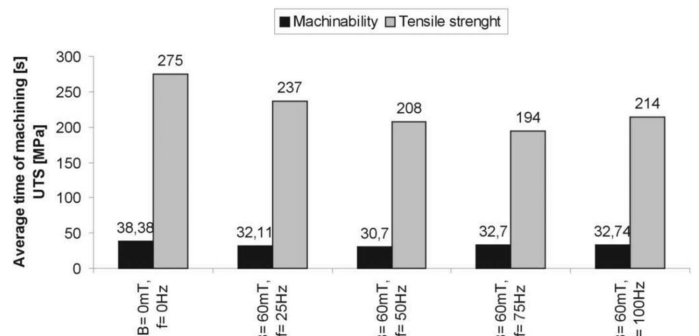
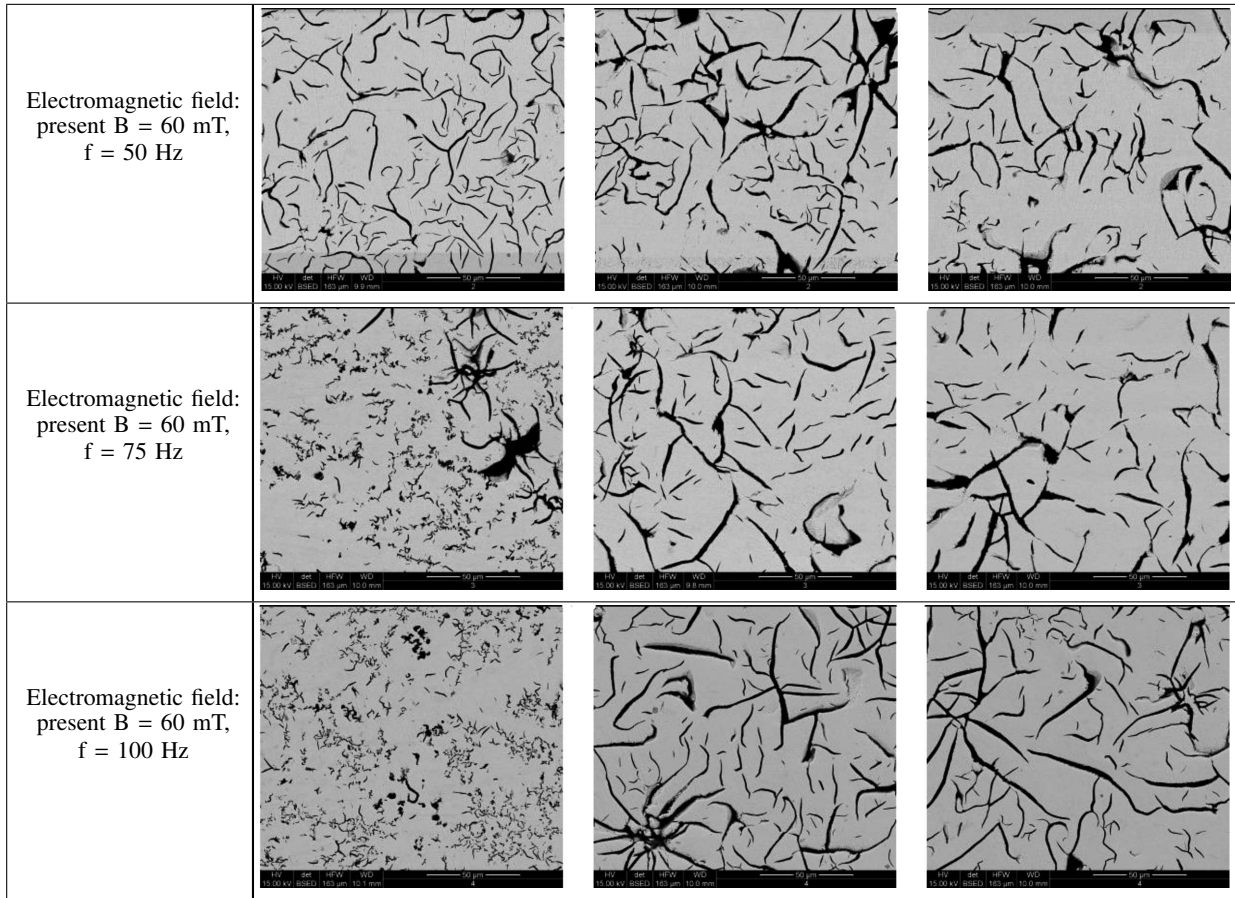

Fig. 6. Influence of the electromagnetic field on machinability and tensile strength UTS of grey cast iron continuous ingot

TABLE 1

Microstructures of grey cast iron EN GJL-200 Grade ingot after cast in continuous casting mould, which contains inductor of rotate electromagnetic field – non-etch microsection

Sample specification	Field of observation		
	Periphery	Half of radius	In axis
Electromagnetic field: lack			
Electromagnetic field: present B = 60 mT, f = 25 Hz			



4. Conclusions

REFERENCES

Based on conducted studies following conclusions have been formulated:

1. Selection of continuous casting parameters that ensure temperature of ingot after leaving the continuous casting mould about 1000°C, allows to reduce defects in the form of fields of hard spots in structure of grey cast iron to about 1%.
2. The change of thermal conditions on the solid/liquid front obtained as a result of the influence of electromagnetic field forced convection of the solidifying metal in continuous casting mould, ensures complete elimination of the presence of fields of hard spots and leads to unification of flake graphite morphology from consideration of its shape and distribution.
3. Increasing the unification of flake graphite morphology is favored by the influence of the electromagnetic field created in the inductor powered with a frequency of supply voltage 50Hz.
4. The unification of flake graphite morphology result from the influence of the electromagnetic field provides a reduction in gradient of hardness on cross-section hardness of ingots, which leads to an improvement in their machinability, while maintaining the tensile strength UTS appropriate to grey cast iron sort EN-GJL-200 Grade.

Acknowledgements

Project financed from means of National Science Centre.

- [1] J. Adamczyk, Engineering of metallic materials, Publishers of Silesian University of Technology, Gliwice, 2004.
- [2] W. Derda, J. Wiedermann, Some aspects of continuous casting of low carbon microalloyed steels with niobium and titanium, Archives of Metallurgy and Materials **57**, 303-310 (2012).
- [3] K. Janerka, M. Pawlyta, J. Jezierski, J. Szajnara, D. Bartocha, Carburiser properties transfer into the structure of melted cast iron, Journal of Materials Processing Technology **214**, 794-801 (2014).
- [4] M. Stawarz, Influence of technological parameters on the microstructure of the silicon cast iron, 22nd International Conference on Metallurgy and Materials, Metal 2013, May 15-17.2013, Brno, Czech Republic, 92-96.
- [5] Z. Malinowski, T. Telejko, B. Hadała, Influence of heat transfer boundary conditions on the temperature field of the continuous casting ingot, Archives of Metallurgy and Materials **57**, 325-331 (2012).
- [6] T. Knych, P. Uliasz, M. Piwowarska-Uliasz, Comparative studies of continuously cast semi-finished Al Grade EN AW 1370, Archives of Foundry Engineering **13**, 65-69 (2013).
- [7] Z. Yan, W. Jin, T. Li, Effect of rotating magnetic field (RMF) on segregation of solute elements in CuNi10Fe1Mn alloy hollow billet, Journal of Materials Engineering and Performance **9**, 1970-1977 (2012).
- [8] Z. Bei Jiang, C. Jianzhong, L. Guimin, Effects of low-frequency electromagnetic field on microstructures and macrosegregation of continuous casting 7075 aluminum alloy, Materials Science & Engineering A **355**, 325-330 (2003).

- [9] T. Wróbel, J. Szajnar, Modification of pure Al and AlSi2 alloy primary structure with use of electromagnetic stirring method, Archives of Metallurgy and Materials **58**, 941-944 (2013).
- [10] T. Wróbel, J. Szajnar, Horizontal continuous casting of Al and Al-Si alloy in semi-industrial conditions, 22nd International Conference on Metallurgy and Materials, Metal 2013, May 15-17.2013, Brno, Czech Republic, 1177-1182.
- [11] J. Szajnar, T. Wróbel, Influence of magnetic field and inoculation on size reduction in pure aluminium structure, International Journal of Materials and Product Technology **33**, 322-334 (2008).
- [12] J. Szajnar, M. Stawarz, T. Wróbel, W. Sebzda, Influence of electromagnetic field parameters on the morphology of graphite in grey cast iron, Archives of Foundry Engineering **9**, 181-184 (2009).

Received: 10 January 2014.