

## OVERLOAD STRESS AND ITS INFLUENCE ON DURABILITY OF CERAMIC ELEMENTS IN HIP AND KNEE JOINTS ENDOPROSTHESES

The paper presents mathematic-statistic methods defining the influence of stress on ceramic elements' durability of hip and knee joints endoprostheses. The tests were conducted with Finite Elements Method in the ADINA System. The obtained results state the influence of load on the values of durability and stress, that get formed in ceramic parts of joints, and help to detect and solve technical problems and thus, counteract the subsequent effects resulting from premature wear of endoprosthesis elements. The paper emphasizes necessity of discovering new materials, that will be bio-compliant and wear resistant. Although ceramic materials like  $Al_2O_3$ ,  $ZrO_2$ , are brittle and less resistant to load than metallic implants, their improving mechanical parameters (excellent tribological properties), make them becoming new standard in biomaterials for clinical use. That opens new possibilities especially for hip or knee joints alloplasty.

*Keywords:* endoprosthesis; stress; ceramic; FEM

### 1. Introduction

Medical ceramics are widely used in orthopedic applications as a replacement for bone matter. Rapid growth in materials research and development is likely to be a key driver for the medical ceramics market, as new materials and production technologies are likely to be developed in the coming years, helping the medical ceramics market achieve smoother operations and higher profit margins. These materials can have greater advantages than CoCr, resulting in less wear of the surface and, consequently, less unwanted wear of the polyethylene. Among ceramics,  $ZrO_2$  is especially suitable for development of implants because of its tensile stress resistance and the possibility to shape it with a thickness similar to that of CoCr components [1,2].

The most common solution offered by endoprostheses producers, as far as joints construction is concerned, is the application of replaceable cup in metal casing. That solution decreases the range of surgery when the friction elements of endoprosthesis are worn. The cups in such systems usually consist of a metal casing made of titanium alloy Ti6Al4V and an appropriate insert. The replaceable internal element can be made of UHMWPE, bio-ceramic or double-layer materials [17,18].

All the ceramic material used in endoprostheses elements are subjected to high loads. It is important, that due to the spe-

cific shape of tribologically cooperating surfaces, the point of contact is formed [3-6].

All the data concerning the durability of ceramic materials can be obtained, by i.e. mathematic-statistic methods. In such case, the tests are conducted on chosen samples with the same kind and size of defects as the analysed parts. The obtained measurements lead to conclusions concerning the parameters of whole group of parts [7-9].

Ceramic composites have been recently used in prosthetic components, presenting minimum wear and excellent long-term results in total knee replacement, due to their high resistance to abrasion. Furthermore, the biologic response to debris generated from these bearings is less aggressive. Tests conducted on knee joint simulator and clinical results, demonstrate promising results of knee joint alloplasty with ceramic components that should led to benefit for the patients [10,11].

Most important for development of ceramic knee components, is the use of existing designs to ensure the same surgical techniques, the same instruments as in case of standard metal femoral components. Ceramic, as a novel material, has higher density, strength and reduced structural flaws. The unique properties of ceramic can reduce polyethylene wear in total knee arthroplasty and the potential detrimental effects of wear particles [12,19].

<sup>1</sup> CZESTOCHOWA UNIVERSITY OF TECHNOLOGY, FACULTY OF MECHANICAL ENGINEERING AND COMPUTER SCIENCE, DEPARTMENT OF TECHNOLOGY AND AUTOMATION, 21 ARMII KRAJOWEJ AV., 42-201 CZESTOCHOWA, POLAND

\* Corresponding author: [marcin@jop.pcz.pl](mailto:marcin@jop.pcz.pl)



Ceramics have a wide field of application in joint replacements. This paper focuses on the application of oxide ceramics in joint replacement bearings. The development of alumina ( $\text{Al}_2\text{O}_3$ ) and zirconia ( $\text{ZrO}_2$ ) for this application is traced since the early 1970s [20-22]. The clinical results of the different bearing couples making use of ceramic components are reported, and the future tendencies in this field of application are summarized.

The innovation mentioned in the paper is application of ceramic elements in knee and hip joint endoprostheses. Additionally the objective of the manuscript is to show that when compared to metal ones or those made of Ultra High Molecular Weight Polyethylene, ceramic elements are bio-compatible, bio-conform and non-toxic and much better transmit loads that human joints are subjected to.

Fig. 1 presents knee joint endoprosthesis with polyethylene insert combined with ceramic femoral component.



Fig. 1. Ceramic Multigen Plus Knee with BIOLOX® delta ceramic femoral component [12]

## 2. Method and methodology

All simulations were conducted by using the ADINA System. The geometrical model was based on real solutions of modular endoprostheses.

The objective of presenting results of tests on endoprostheses with elements made of metal alloys and polyethylene, is to demonstrate the utility differences between them and those with ceramic elements, in favor of the ceramic ones.

### 2.1. Numerical analysis of overload stress and strain in “head – cup” set of hip joint endoprosthesis

The geometric model is based on the real endoprosthesis solution of Aesculap [17], where diameters of particular elements are:

- 28 mm head,
- 40 mm cup,
- 48 mm casing,
- 60 mm bone.

Figs 2 and 3 presents simplified model used for calculations.

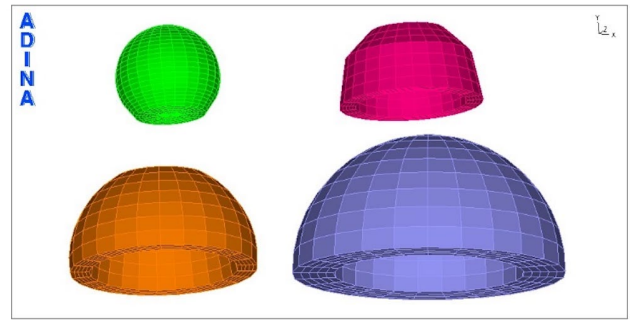

Fig. 2. Geometrical model of “head-cup” set of elaborated solution

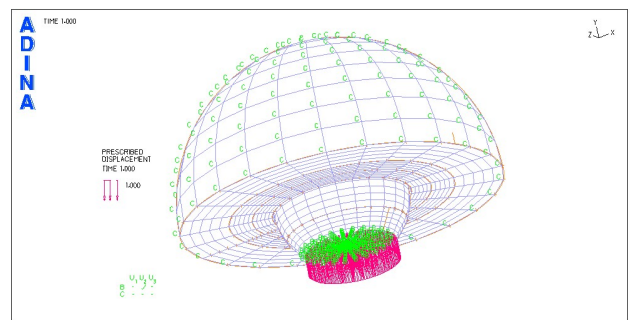

Fig. 3. Model of discreet elaborated solution

Discreet model consists of 10000 cubic elements distributed on 10292 nodes. 8 node elements 3D Solid were used to build up the model [13].

Mechanical parameters of the materials and bone tissue used in analysis are presented in the TABLE 1.

TABLE 1

Mechanical features of biomaterials and bone tissue [14]

Element of the model	Young's module [MPa]	Poisson's coefficient $\nu$
Core bone	$1,7 \times 10^4$	0,35
Alloy Ti6Al4V	$1,1 \times 10^5$	0,3
Ceramics $\text{Al}_2\text{O}_3$	$3,8 \times 10^5$	0,22

In the discreet model of “head-cup” both elements are ceramic. In the tested set the load refers to the load to which the head is subjected in the plain XY with strength 600 N and 900 N.

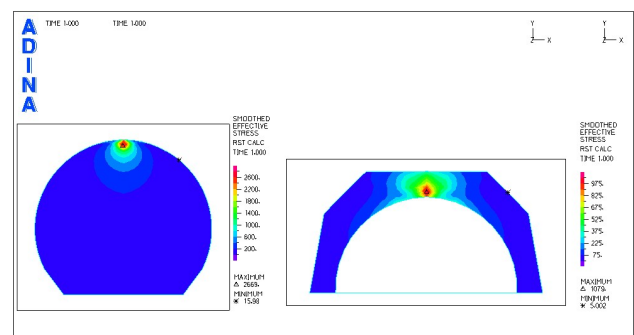

Fig. 4. Stress patterns  $\sigma_{zr}$  [MPa] in cross-section of each element of the analyzed system of: ceramic head-ceramic cup, with the load 600 N

The obtained results proved that due to the cooperating elements' parameters, the contact point occurs. It concentrates the stress which can reach in the surface area 2669 MPa when the load is 600 N, and 2900 MPa when the load is 900 N. The contact point between the cooperating surfaces transfers the stress onto the cups. Selected stress pattern in cross section of casing of core bone in the analysed system presents Fig. 5. Strain patterns in cross-section for each element of the analyzed system: ceramic head-ceramic cup with the load 600N illustrates Fig. 6.

Fig. 7 illustrates the state of the maximum values of stresses in the elements of the analysed system and Fig. 6 presents the state of the values of strain.

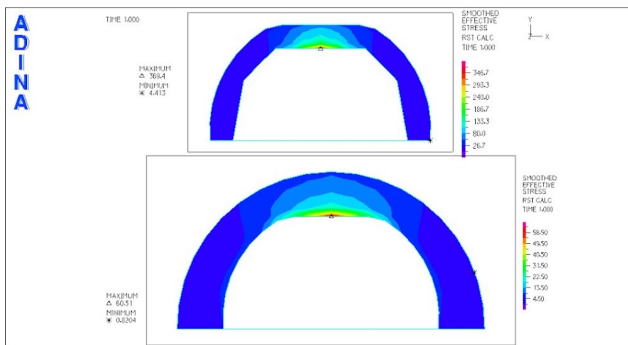

Fig. 5. Stress pattern  $\sigma_{zr}$ , MPa in cross section of casing of core bone in the analysed system, with the load 600 N

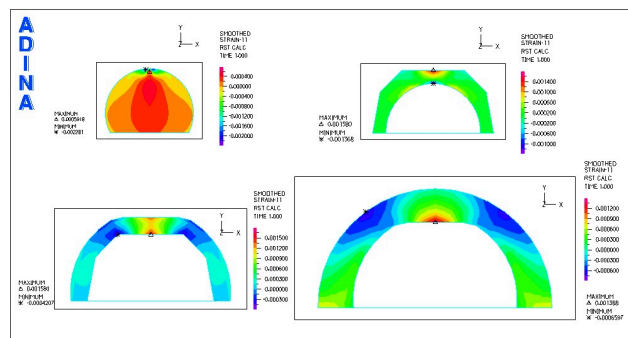

Fig. 6. Strain patterns in cross-section for each element of the analyzed system: ceramic head-ceramic cup with the load 600 N

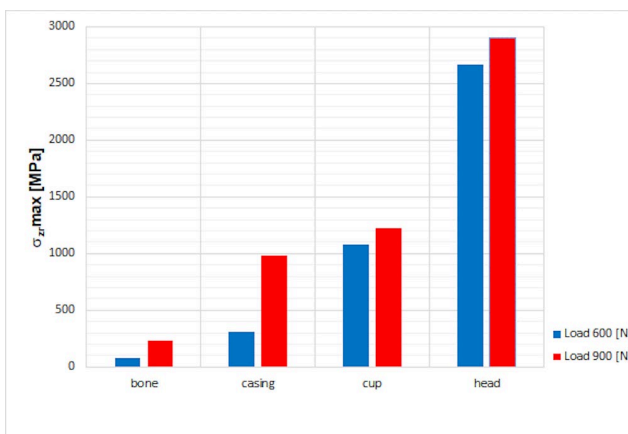

Fig. 7. Statement of the maximum values of stresses in the elements of the analysed system with the load 600 N and 900 N

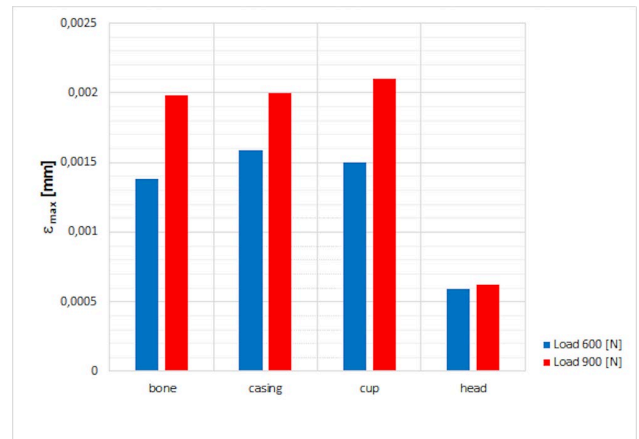

Fig. 8. Statements of the values of strain in the analysed system with the load 600 N and 900 N

The strain distribution showed that biggest strain values occur in the area where the cup is connected with the casing, and that the pelvis bone was deformed.

The obtained stress and strain distribution for the assigned materials prove that the ceramic elements in the analysed system will not be damaged.

Within conducted tests on hip joint endoprosthesis simulator [15], aiming at defining the influence of friction pair “head-cup” on friction resistance, it has been detected that ceramic elements, subjected to load and variable operational conditions, do not practically exhibit any wear or damage. Schematic diagram of the stand for testing durability of human hip joint endoprosthesis presents Fig. 9. Friction coefficient values for chosen friction pairs, are presented on Fig. 10.

All the above results were positively confirmed in the empirical tests carried out on the hip joint simulator in the biotribology laboratory in the Department of Technology and Automation of Technical University of Czestochowa. When

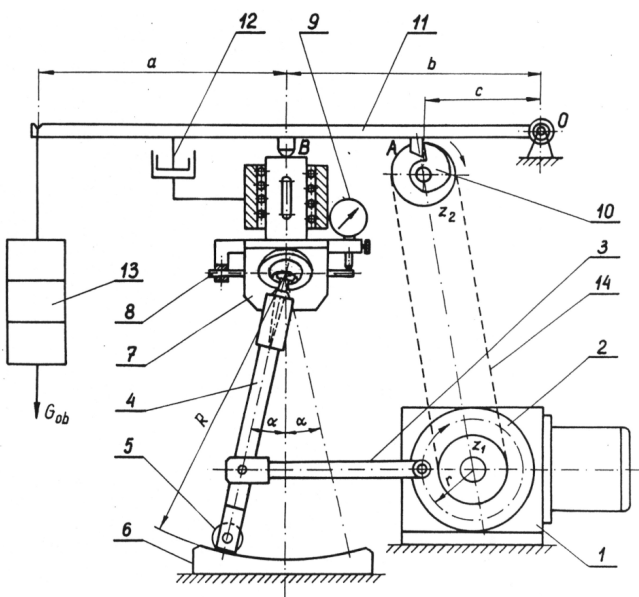

Fig. 9. Schematic diagram of the stand for testing durability of human hip joint endoprosthesis [15]

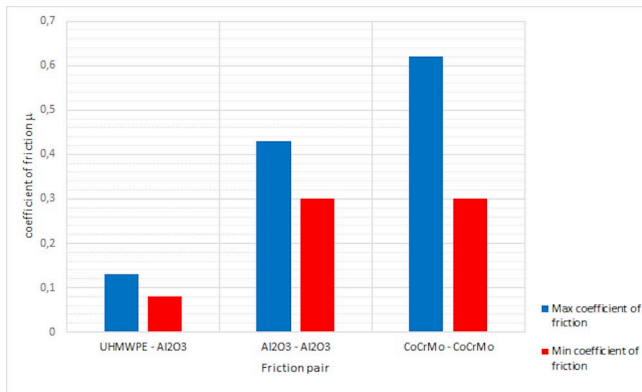

Fig. 10. Summary of the friction coefficient of the analyzed friction pairs

the real set “ceramic head-ceramic cup” was subjected to load 600 N and 900 N respectively, the values of friction coefficient grew significantly for that set run. However that did not cause any damage of the analysed ceramic elements.

## 2.2. Numerical model of knee joint endoprosthesis

Numerical model is a simplified version of the original endoprosthesis, though the sleds’ geometry has been maintained. That enables us to keep the general shape of endoprosthesis and to quite closely imagine the strain distribution on the insert’s surface.

The geometric model is based on the real knee endoprosthesis solution of Ceramic Multigen Plus Knee. The finite elements mesh was built of 3600 cube-shaped elements of 3D Solid type and 4312 nodes. The model presented in the paper, consists of the elements respective to all parts of endoprosthesis: metal sled and Ultra High Molecular Weight polyethylene insert. Additionally, there are presented numerical calculations defining the influence of the implant geometry on the stress pattern in the contact area of the cases: sled with the cross section radius 17 mm – spherical and flat insert and sled with the cross section radius 27 mm – spherical and flat insert.

The Fig. 11 presents the simplified sled model.

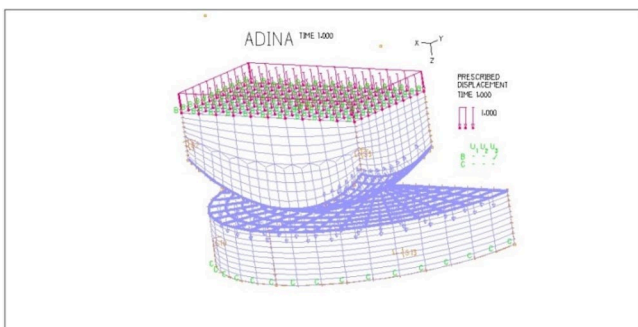

Fig. 11. Simplified sled model used for calculations

The main purpose of calculations was to define stress distribution on the surface of the polyethylene insert and right underneath it, where the ceramic or metal sled operates. The key

dimension in the analysis is the thickness of the insert defined as  $G$ . There were three thicknesses of polyethylene inserts analyzed: 8, 13 and 22 mm, and two sleds of cross section radii of 17 and 27 mm, respectively. The analyzed sleds were made of CoCrMo, Ti6Al4V, Al<sub>2</sub>O<sub>3</sub>, ZrO<sub>2</sub>. Fig. 12 presents sleds’ geometry of the analyzed knee joint endoprosthesis.

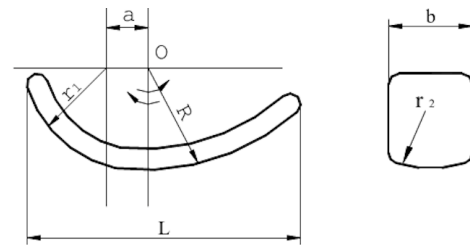

Fig. 12. Knee joint endoprosthesis sled’s geometry. Side and front view

Sled’s geometric value, accepted as a specific parameter, defined cross-section radius of a sled. Constant geometric diameters are:

1. Sled of geometry:  $R = 28$  mm;  $r_1 = 15$  mm;  $r_2 = 27$  mm;  $L = 46$  mm;  $b = 17,5$  mm
2. Sled of geometry:  $R = 26$  mm;  $r_1 = 16$  mm;  $r_2 = 17$  mm;  $L = 45$  mm;  $b = 16$  mm

Fig. 13 presents the simplified polyethylene insert of thickness  $G = 8$  mm, used in tests conducted on knee joint simulator.

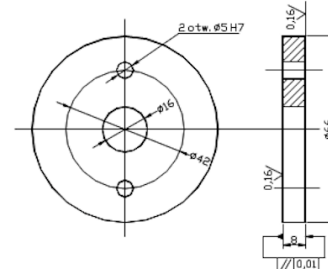

Fig. 13 The simplified polyethylene insert of thickness  $G = 8$  mm

There were conducted 24 numerical analysis for three various thicknesses of polyethylene inserts cooperating with two geometrically different sleds made of four different materials. Each pair was subjected to load  $F = 1500$  N. Simulations of the cases were conducted with the following, accepted physical features of the materials presented in the TABLE 2.

TABLE 2

Mechanical features and weight density of the materials used for endoprostheses [16]

Material	Young’s modulus $E$ [GPa]	Poisson’s coefficient $\nu$	Weight density $\rho$ [kg/m <sup>3</sup> ]
CoCrMo	210	0,3	8300
Ti6Al4V	120	0,35	4500
Al <sub>2</sub> O <sub>3</sub>	300	0,22	3750
ZrO <sub>2</sub>	270	0,23	3600
UHMWPE	0,2	0,4	960



### 2.3. The results of numerical analysis conducted with the use of Finite Elements Method

The calculations prove that stress in endoprosthesis is concentrated in the polyethylene insert, right underneath the contact area of both elements, and highest stress is located right underneath the insert's surface. Some examples of the calculations of contact stress and strain distribution present Figs 14, 15 and 16.

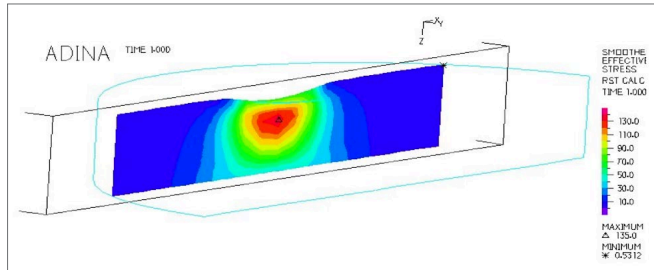

Fig. 14. Contact stress distribution occurring in the polyethylene insert. The insert 8 mm thick cooperates with a sled of radius 17 mm. Load 1500 N

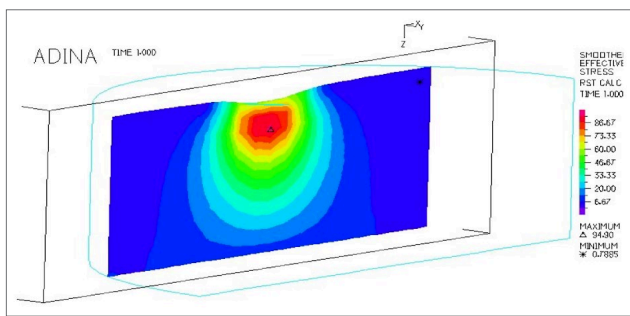

Fig. 15. Contact stress distribution occurring in the polyethylene insert. The insert 13 mm thick, cooperates with sled of radius 27 mm. Load 1500 N

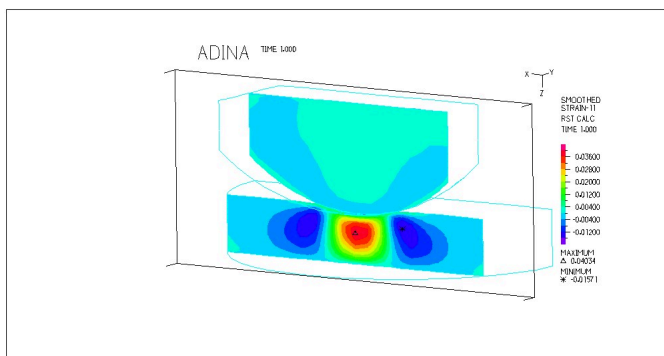

Fig. 16. Strain distribution occurring in the polyethylene insert. The insert 8 mm thick, cooperates with sled of radius 27 mm. Load 1500 N

The lowest reduced stress was achieved for the model where the sled's cross-section radius is 27 mm, PE insert's thickness is 22 mm and the sled is made of Ti6Al4V alloy and valued 9,29 MPa. The highest stress occurred in the model where the sled was made of ceramic ( $\text{Al}_2\text{O}_3$ ), and valued 38,85 MPa, and PE insert's thickness is 8 mm and the sled's cross section radius

was smallest and valued 17 mm. Fig. 17 presents the influence of the sled's cross section radius, Ultra High Molecular Weight Polyethylene insert's thickness and kind of a sled's material on value of stress generated in a polyethylene inserts.

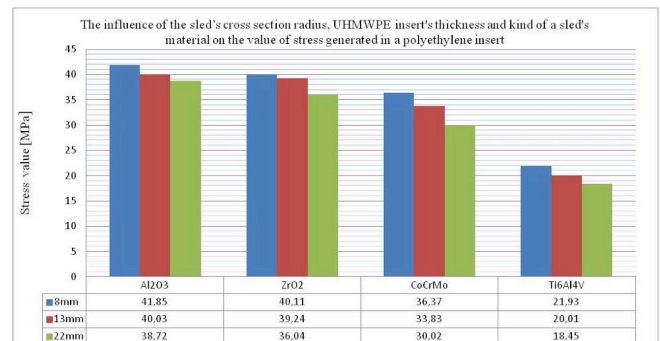

Fig. 17. The influence of the sled's cross section radius, UHMWPE insert's thickness and kind of a sled's material on the value of stress generated in a polyethylene inserts

### 3. Conclusion

1. The strain distribution is highest in the area where the cup is connected with the casing, and that the pelvis bone was deformed.
2. The obtained stress and strain distribution for the assigned materials prove that the polyethylene elements in the analysed system ("polyethylene-ceramic") will not be as damaged as in case of pair "polyethylene-metal".
3. The conducted numerical calculations and analysis prove that the future of knee joint alloplastics belongs to a group of new materials including titanium alloys and ceramic elements, which when appropriately selected and combined as far as mechanical features are concerned (low Young's modulus value), may significantly decrease the value of stress generated in polyethylene elements of endoprostheses.
4. Another important feature influencing durability of knee joint endoprostheses, is optimizing of the geometry of the implants in the friction node. Basing on presented tests results, it has only been pointed out, that in knee joint endoprosthesis with sled of 27 mm cross section radius, the value of stress is significantly lower (10-12%) than in case of 17 mm cross section radius sled, what effects in decreased volume of debris and increased durability of endoprosthesis.

### REFERENCES

- [1] A. Polyakov, V. Pakhaliuk, M. Kalinin, V. Kramar, *Procedia Engineering* **100**, 530-538 (2015). DOI: <https://doi.org/10.1016/j.proeng.2015.01.400>
- [2] P. Janíček, V. Fuis, M. Málek, *Acta Mechanica Slovaca* **14** (4) 42-51 (2010). DOI: <https://doi.org/10.2478/v10147-011-0033-9>

- [3] S. Ahmad, Y. Liu. *Procedia CIRP* **89**, 68-73 (2020). DOI: <https://doi.org/10.1016/j.procir.2020.05.120>
- [4] S.K. Fokter, A. Moličnik, R. Kavalarič, P. Pelicon, *Journal of the Mechanical Behavior of Biomedical Materials* **69**, 07-11 (2017). DOI: <https://doi.org/10.1016/j.jmbbm.2016.12.012>
- [5] D. Vogel, A. Falkenberg, S. Bierbaum, *The Journal of Arthroplasty* **32**, 8, 2580-2586 (2017). DOI: <https://doi.org/10.1016/j.arth.2017.03.033>
- [6] E.A. Audenaert, V. Khanduja, C. Bauwens, *Clin. Biomech.* **70**, 186-191 (2019). DOI: <https://doi.org/10.1016/j.clinbiomech.2019.09.004>
- [7] D. Kiyoshi Fukumothi, H. Pupo, L.A. Reganin, *Rev. Brasil. de Ortop.* **51**, 5, 569-573 (2016). DOI: <https://doi.org/10.1016/j.rboe.2016.08.012>
- [8] M.N. Rahaman, B. Bal, J.P. Garino, *J. Am. Ceram. Soc.* **90** (7), 1965-1988 (2007). DOI: <https://doi.org/10.1111/j.1551-2916.2007.01725>
- [9] V. Gopal, G. Manivasagam, *Applications of Nanocomposite Materials in Orthopedics*, 201-219, (2019). DOI: <https://doi.org/10.1016/B978-0-12-813740-6.00011-9>
- [10] <https://www.ceramtec-medical.com/en/infocenter/ceranews/archive>, accessed 17.01.2021
- [11] Ch.F. Scifert, T. Brown, J. Lipman, *Clinic. Biomechanics* **14**, 697-703 (1999). DOI: [https://doi.org/10.1016/S0268-0033\(99\)00054-6](https://doi.org/10.1016/S0268-0033(99)00054-6)
- [12] P. Bergschmidt, R. Bader, D. Ganzer, *The Open Orthopaedics Journal* **6**, 172-178 (2012).
- [13] ADINA. *Theory and Modeling Guide*, Adina R&D, INC. 2012.
- [14] R. Będziński, *Biomechanical engineering*, Publishing House of the Wrocław University of Technology, Wrocław (1997).
- [15] *Praca zbiorowa pod red. M. Gierzyńskiej-Dolnej: Optymalizacja doboru materiałów i obróbki powierzchniowej niektórych endoprotez narządów ruchu człowieka w oparciu o badania tarciowo-zużyciowe. Sprawozdanie z projektu badawczego Nr 7 T08C 03809*, (1998).
- [16] J. Marciniak, *Biomaterials*, Publishing of Silesian University of Technology, Gliwice (2002).
- [17] <https://knoglemekanik.dk/Vejledning/O10702%20Bicon-tact%202013.pdf>, accessed: 17.01.2021.
- [18] <https://www.bbraun.pl/pl/products/b/metha-short-hip-stem.html>, accessed: 17.01.2021
- [19] H.F. El'Sheikh, B.J. MacDonald, *Jour. of Mater. Proc. Tech.* 143-144, 249-255 (2003).
- [20] J. Knapczyk, M. Góra-Maniowska, *Acta Mechanica et Automatica* **11**, 4 (2017). DOI: <https://doi.org/10.1515/ama-2017-0050>
- [21] T. Madej, A. Ryniewicz, *Tribologia* **2**, 115-128 (2013).
- [22] T. Madej, A. Ryniewicz, *Analiza naprężeń i przemieszczeń w strefie roboczej endoprotezy stawu biodrowego*, *Mechanika w Medycynie* **6**, 127-134 (2002).