

J. SIDOR*

MECHANICAL DEVICES USED FOR PRODUCTION OF METALLIC, CERAMIC-METALLIC ALLOYS OR NANO-MATERIALS

URZĄDZENIA MECHANICZNE W TECHNOLOGIACH WYTWARZANIA STOPÓW I NANOMATERIAŁÓW METALICZNYCH ORAZ METALOCERAMICZNYCH

Some metallic alloys, and especially the ceramic-metallic ones, are produced using mechanical methods only by application of mechanical devices – mills. These mechanical methods are applied mostly for production of amorphous alloys, however in many cases they are also applied for production of crystalline alloys. These methods are specifically applied for production of metallic nano-materials and high-purity metals. These methods include: mechanical alloying (MA), high energy ball milling (HEBM) or reactive milling (RM). These methods use mainly the vibratory, planetary, mixing, impeller, rotary-magnetic, gravitational or rotary-vibratory free grinding medium mills. This paper presents operation principles, basic technical parameters and some design solutions of these mills. It includes also an application example of the rotary-vibratory mill for production of the nickel and zirconium or pure nickel crystalline alloys and also the amorphous $\text{Ni}_{50}\text{Zr}_{50}$ alloy.

Keywords: mechanical alloying, $\text{Ni}_{50}\text{Zr}_{50}$ alloy, nanopowders, mills for nanotechnology, reactive milling

Niektóre stopy metaliczne oraz metaloceramiczne, wytwarzane są tylko metodami mechanicznymi z zastosowaniem urządzeń mechanicznych – młynów. Największe zastosowanie metody mechaniczne znalazły przy wytwarzaniu stopów amorficznych, chociaż w wielu przypadkach stosuje się je przy wytwarzaniu stopów krystalicznych. Szczególne zastosowanie mają te metody przy wytwarzaniu nanomateriałów metalicznych i otrzymywaniu metali o bardzo wysokiej czystości. Wśród tych metod wyróżnić można: mechaniczną syntezę (MA), wysokoenergetyczne mielenie (HEBM) oraz reaktywne mielenie (RM). W metodach tych stosuje się głównie młyny z mielnikami swobodnymi: wibracyjne, planetarne, mieszadłowe, wirnikowe, obrotowo-magnetyczne, grawitacyjne i obrotowo-wibracyjne. W pracy przedstawiono sposoby działania tych młynów, ich podstawowe parametry techniczne oraz niektóre rozwiązania konstrukcyjne. Podano również przykład zastosowania młyna obrotowo-wibracyjnego w wytwarzaniu stopów krystalicznych: niklu z cyrkonem oraz czystego niklu, a także stopu amorficznego $\text{Ni}_{50}\text{Zr}_{50}$.

1. Introduction

Within last years of XX century and first years of XXI century a quick development of material engineering occurred using the metallic, ceramic-metallic, ceramic, chemical or organic [1, 2, 3] material nano-structures. Metallic or ceramic-metallic nano-structures, including composites, are of special importance and are necessary for production of modern machinery, mechanical devices and they are also applied in a space technology or metrology devices [4, 5]. Therefore the high-school's or industrial research laboratories produce newer and newer materials, including amorphous or crystalline metallic or ceramic-metallic alloys with significantly better properties as compared to those of the known and used materials. These are materials of significantly higher mechani-

cal strength, higher hardness, plasticity; corrosion, abrasion or creeping resistance as well as significantly better magnetic properties [6]. The known and applied alloy or metallic and ceramic-metallic nano-material production methods are [1, 3, 4, 5]:

- mechanical – basing on generating of large number of crystalline structure defects (dislocations, grain limits, etc.) in poly-crystalline materials, including the mechanical crumbling, push-through or rolling processes,
- physical – including processes of crystallization from the meta-stable or unstable condensed phases, mainly by crystallization or precipitation processes from the supersaturated permanent solutions,
- radiational – by radiation with high-energy particles,
- chemical.

* FACULTY OF MECHANICAL ENGINEERING AND ROBOTICS, UNIVERSITY OF SCIENCE AND TECHNOLOGY, 30-059 KRAKÓW, AL. MICKIEWICZA 30, POLAND

Some of the metallic, crystalline or amorphous nano-structures can be produced only using mechanical methods, with application of the high-energy free grinding medium mills.

2. Effect of material graining to its physical properties

The most important properties of the metallic nano-materials are the mechanical and magnetic ones. For traditional metal or metal-alloy poly-crystalline nano-powders the yield point (σ_y) increase occurs with the grain size decrease.

It is described by the Hall-Petch equation [4, 5]:

$$\sigma_y = \sigma_o + \frac{k}{\sqrt{d}}, \tag{1}$$

where: d – grain size, σ_o – friction tension counteracting the dislocation sliding movement, k – factor of grain limit resistance towards sliding transfer.

Analogical dependence occurs with the hardness [4, 5]:

$$H_y = H_o + \frac{k_H}{\sqrt{d}}, \tag{2}$$

where: H_y – material hardness, H_o – constant of crystals friction – network resistance at a dislocation movement [4, 5], k_H – temperature independent constant.

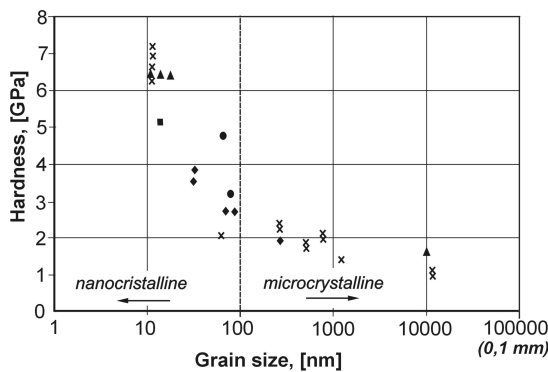

Fig. 1. Effect of the nickel crystal grain sizes to its hardness [7]

In majority of metallic nano-crystalline materials one can find the 4÷5 time hardness increase as compared to traditional materials. Figure 1 shows effect of the nickel crystal grain sizes to its hardness [7], where the grain size decrease from 100 μm to ca. 10 nm caused ca. 7-time increase of its hardness.

3. Mechanical methods for production of metallic and ceramic-metallic nano-structures

Literature [1, 2, 3, 5, 6, 7] describes dozens methods for production of metallic or ceramic-metallic nano-structures. The trial classification is proposed in Fig. 2. Bold types point-out mechanical methods, which are the subject of this paper. As the classification criterion they assumed the process kind occurring in these methods. It shall be assumed that this classification shall subject to further modification in parallel to development of the new nano or micro-structure production methods.

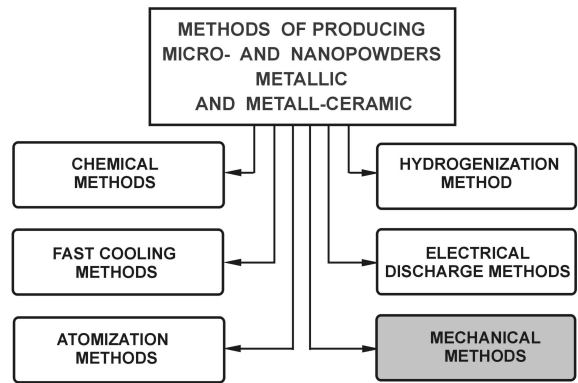

Fig. 2. General classification of the metallic and ceramic-metallic micro and nano-powders production methods

Fig. 3 shows the classification of most frequently applied mechanical methods. The classification criterion is the process nature found in particular methods. Classification of mechanic methods shall subject to modifications, just as the general one.

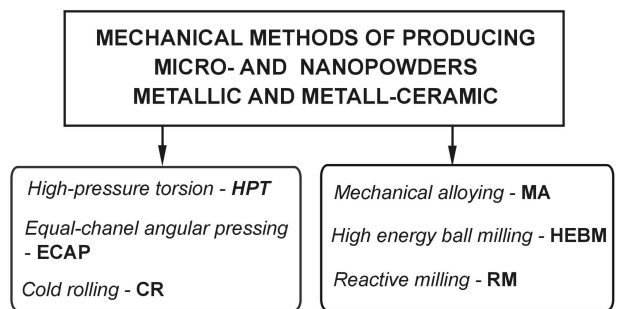

Fig. 3. Classification of the metallic and ceramic-metallic micro and nano-powders mechanical production methods

The HPT, ECAP and CR methods are less significant. The most commonly used methods are the MA, HEBM and RM ones belonging to the second group methods.

The most common is the MA (Mechanical Alloying) method basing on powder milling using the gravi-

tational and vibratory, planetary, rotary-magnetic or impeller type free grinding medium mills. This method was started at the end of 60-ties [10]. Till the 1980 majority of researches related to the dispersion hardened, Ni, Fe or Al based, super-alloys. New nickel and niobium phases were obtained in the 1983 by C.C. Koch [11]. Results of important researches relating to production of ceramic-metallic and ceramic nano-materials were published in 1997 by P. Matteazi, G. Le Caër and A. Mocellin. [12]. First amorphous $\text{Ni}_{50}\text{Zr}_{50}$ alloy was obtained in AGH by MA method in 1997 using the rotary-vibratory mill [13]. During milling of high-purity powders, strongly supersaturated solutions are created, from which, unbalanced crystalline, amorphous or nano-metric structures are produced by an annealing. The alloy produced by MA method may be:

- solid solution,
- inter-metallic phase,
- mix of components,
- amorphous material.

Second method for production of micro or nano-structures is the HEBM (High Energy Ball Mill) [2]. It uses a high-energy graining process occurring also inside the free grinding medium mills. The raw material is the inter-metallic powder with the graining less than $100\ \mu\text{m}$, with known chemical composition and crystallographic structure. As distinct from the MA method, high purity metallic powders are used only. The HEBM method product depends on: mill type, chamber filling rate, grinding medium/powder weights ratio, process temperature and atmosphere. Using the HEBM method it is possible to obtain, after 20 hours, the amorphous ZrV_2 , alloy, which after a thermal treatment forms the crystalline structure with ca. 30 nm crystallites. This method is applied for reversibly hydrogen-absorbing materials, i.e. composite nano-materials, e.g.: ZrV_3 10% by weight Ni. The final alloy is the $\text{Zr}_{0,5}\text{Ti}_{0,5}\text{V}_{0,8}\text{Mn}_{0,8}\text{Cr}_{0,4}$. This method was used in the Material Engineering Institute of Poznan University of Technology for production of magnetic hard nano-crystalline alloys [2]. Third mechanical method is the RM (Reactive Milling). The RM basis was developed within the 80-ties of XXth century. This process was used for production of pure metallic materials [2]. The RM process causes the solid body / solid body or liquid / solid body reaction. For example:

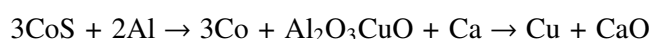
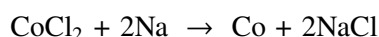

First tests of chemical reactions, with replacement of the mechanical energy to the chemical one were carried in the 1894 [5]. The literature calls this RM

method the mechanosynthesis or, more frequently the mechanochemicalsynthesis [5]. During the RM process, due to thin component layers and many superficial defects, the diffusion speed increases and it facilitates the reaction course, with small energy consumption. The RM process can run in a mild or turbulent way, where the self-developing “burning” reactions occur.

4. Mechanical devices used for plastic deformation methods

Method group – Fig. 3 includes high-pressure torsion (HPT), equi-canale angle pressing (ECAP) or cold rolling (CR). The first two methods produce directly metallic materials with the $100\div 300\ \text{nm}$ grains [8]. In the HPT method – Fig. 4 the disc-shaped metallic sample subjects to a large deformation during a torsion, which occurs under a pressure of several GPa in the room temperature. The body ensures a sample immobilization, while the rotating piston causes the material deformation resulting from an intensive superficial friction.

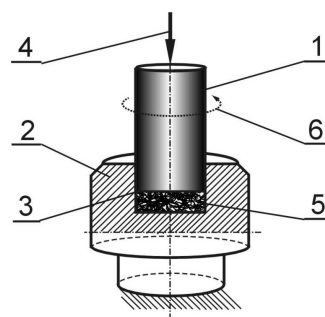

Fig. 4. Schematic diagram of the HPT method: 1 – piston, 2 – body, 3 – unit pressure (20 GPa), 4 – force, 5 – sample, 6 – piston rotation

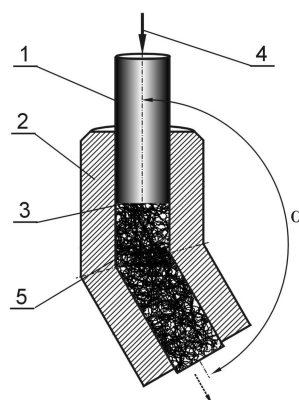

Fig. 5. Schematic diagram of the ECAP method: 1 – piston, 2 – body, 3 – unit pressure (20 GPa), 4 – force, 5 – sample

In the ECAP method – Fig. 5 the sample is pushed through a mould created by two heavy wall tubes with

the same internal diameters, joined together under the angle α , less than 180° . The sample pushed through such formed mould, and due to deviation of their geometrical axes, subjects to shearing in the point where it passes through the pipe-joint. Since the equal internal pipes cross-sections make it impossible a deformation of their cross-sections they cause sample deformation on the cross-section change surface from the body upper part to the lower one. This method is more suitable for the technical scale.

Fig. 6 presents the cold rolling (CR) method [9].

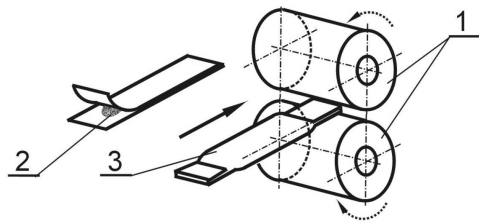

Fig. 6. Schematic diagram of the CR method: 1 – rolls, 2 – sample, 3 – sample multi-rolling process

This method was applied in Japan [9] for production of materials characterizing with unstable thermodynamic structure, i.e.: Al-Fe, Fe-Sn or Ag-Fe alloys. The raw

materials were the high-purity powder mixes (99.9%): aluminum, iron, tin and silver. Such mix was hermetically closed inside the $\varnothing 18$ mm steel pipe, in the argon atmosphere and repeatedly rolled in the room temperature between the $\varnothing 150$ mm rollers. After such rolling the pipe containing the powder mix sample was deformed till the thickness of ca. 0.5 mm.

5. Devices used for mechanic methods, where the milling process occurs

The basic mechanical devices used in this mechanical method group, both for laboratory or industrial applications, are the vibratory, planetary, mixing, impeller, rotary-magnetic, gravitation and rotary-vibratory free grinding medium mills – in the AGH – The University of Science and Technology and The Silesian University of Technology [13, 14, 15]. The basic MA, HEBM or RM process and mills parameters are: ball diameters and weights, dimensions, chamber volume and shape, chamber filling ratio, ball impact speed and energy, ball impact frequency, chamber vibration frequency and amplitude, vibration amplitude trajectory, ball/powder weight ratio (BPR), process temperature and the process control agent (PCA). Table 1 shows a comparison of basic mill and MA, HEBM and RM process parameters.

TABLE 1
Basic mill and MA process parameters. Parameters determined by: 1 – B.S. Murty, S. Ranganthan [14], 2 – M. Abdellaoni, E. Gaffet [15], 3 – T. Tanaka, S. Nasu, K.H. Ishikara, P.H. Shinghu [16], 4 – J. Sidor

Parameter	Type of mill				
	Gravitation	Shaker	Planetary	Attritor	Rotary-vibratory
Ball speed, m/s	$0.7 \div 0.8^4$	$< 3.9^2$	$< 2.5 \div 4^2$	$< 0.8^1$	$1.6 \div 3.6^4$
Kinetic energy ball, 10^{-3} J/impact	$1.1 \div 1.4^4$	$< 120^2$	$< 10 \div 400^2$	$< 10^2$	$12.8 \div 64^4$
Ball impact frequency, Hz	$50 \div 70^4$	200^2	$\approx 100^2$	$> 1000^2$	$250 \div 700^4$
Time of process MA, hour	$600 \div 2000^3$	$< 50 \div 80^2$	$< 60 \div 64^2$	$< 80 \div 120^2$	$< 50 \div 80^4$
Powder weight in chamber, g; kg	$4 \times 2000 \text{ g}^1$	$2 \times 20 \text{ g}^1$	$4 \times 250 \text{ g}^1$	$0.5 \times 100 \text{ kg}^1$	$30 \div 500 \text{ g}^4$

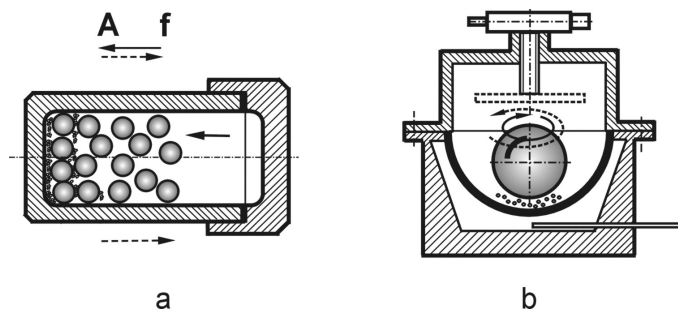

Fig. 7. Schematic diagrams of vibratory mills: a – shaker type, b – one-ball reversible type, A – vibration amplitude, f – vibration frequency

In order to determine the kinetic energy of the balls inside the rotary-vibratory mill, two methods were developed by J. Sidor: computer simulation method and visualization method [17, 18].

Vibratory mills characterize with larger design differences caused by the sectional, circular or spatial vibration amplitude types. Operational diagrams of the two often used vibratory mills, see Fig. 7.

The shaker-type mill (Spex 8000, USA) has the vibration frequency 20 Hz, vibration amplitude 5 mm (sectional) and the Froude number 8 [2].

The one-ball mill from Fritsch, Germany has the vibration frequency 1÷10 Hz, vibration amplitude 5 mm (circular in horizontal plane) and the Froude number 2 [4].

The two mills are suitable for the MA, HEBM or RM process in the inert gas atmosphere, on periodical basis. Researches of the MA, HEBM or RM process were carried also inside the classical tube vibratory mills, equipped with special chambers. These processes more and more frequently are researched in specially designed mills, characterizing with wide range of research possibilities [19, 20]. One of such mills is the tube, two-chamber vibratory mill suitable for continuous process, developed by the Technische Universität Clausthal [21], which enables carrying the milling processes, even at the liquid nitrogen temperature.

cated next to the rotating chamber. The grinding medium kinetic energy (generated by the rotary and linear movements) in this mill may be adjusted within a large range by changing the solenoid location in relation to the chamber or by its current value. The two mill types, due to small less than 200 cm³, chamber volumes are suitable as the laboratory mills only.

Figure 9 shows operational diagram of the mixing mill, called the “atrittor”, and the impeller mill with very high grinding medium energy. These mills are used as the laboratory or industrial ones. The grinding medium energy sources in the two mills are the rotating impellers. The mill chambers are immobile. Thanks to it the mills characterize with a small harmful effect to environment. The two mills disadvantage is a several-time larger power consumption as compared to other designs as well as necessary application of the higher starting torque motors.

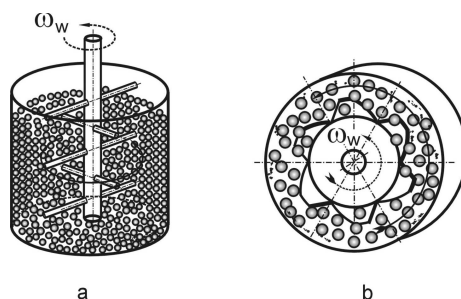

Fig. 9. Operational diagram of the mills: a – mixing mill – atrittor, b – impeller mill, ω_w – impeller angular speed

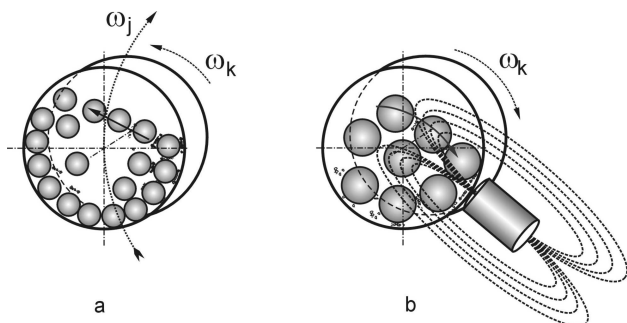

Fig. 8. Operational diagrams of the mills: a – planetary type, b – rotary-magnetic type, ω_k – chamber angular speed, ω_j – yoke angular speed

Figure 8 shows operational diagrams of two mill types, very often used in laboratory practice: planetary or rotary-magnetic ones. The planetary mill is produced for years in several versions: as four-, two- or lastly one-chamber ones by the Fritsch [22] or Retsch [23] companies from Germany. For the MA, HEBM or RM purposes these mills are equipped with chambers and grinding media made of the corrosion resistant steel. The rotary-magnetic mill is quite original design developed by an Australian company [24]. In this mill the ball kinetic energy is generated by mechanical and electromagnetic method, i.e. by a chamber rotation and an electro-magnetic force produced by a solenoid lo-

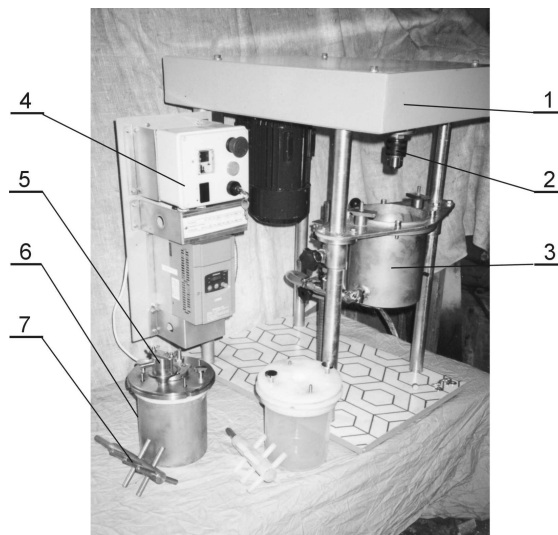

Fig. 10. Photo of laboratory mixing mill LMM-D-2 with the chamber and impeller made of corrosion resistant steel and adopted for milling in the inert gas atmosphere: 1 – mixing drive, 2 – mixer holder, 3 – tank with water jacket, 4 – control system, 5 – powder separator, 6 – steel chamber, 7 – steel mixer

The impeller of the mixing mill is vertically situated and equipped with mandrels. The impeller is surround-

ed by grinding medium and treated material [2, 3, 4, 5]. Fig. 10 shows the high-energy mixing mill used in the Material Science Faculty of The Silesian University of Technology [25].

The LMM-D-2 mill has the 1.8 dm³ volume chamber with internal powder separator, 1.5 kW power motor, 100÷450 rpm impeller rotation speed and its weight is 105 kg.

Inside the impeller mill [26] (Fig. 9) the horizontally situated impeller consists of shaped discs joined co-axially, in some spacing. The impeller is surrounded by grinding medium and treated material within the lower zone only.

High-energy impeller mill CM-8 type from ZOZ GmbH, Germany, has the 8 and 5 dm³ volume chambers; atmosphere: vacuum or inert gas, and the vacuum is the 10⁻² Pa to 0.2 MPa; and operational temperature from minus 100°C to plus 20°C.

TABLE 2

Basic parameters of laboratory and industrial impeller mills [27]

Type of mill	Power, kW	Volume of chamber, dm ³	Using	Weight material (Cu)
CM01	2,7	1 and 2	Laboratory	200 g
CM08	16,6	5 and 8	Lab./industry	800 g
CM20	22	10 and 20	Lab./industry	2 kg
CM100	60	100	Industry/lab.	20 kg
CM400	220	400	Industry	100 kg
CM900	500	900	Industry	250 kg

Metallic crystalline or amorphous alloys are produced in the AGH and The Silesian University of Technology using the rotary-vibratory mills [13, 17]. Operational diagram of such mill is shown in Fig. 11.

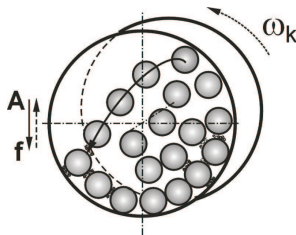

Fig. 11. Operational diagram of the rotational and vibratory mill: A – vibration amplitude, f – vibration frequency, ω_k – chamber angular speed

Fig. 12 shows one of the laboratory rotary and vibratory mills. This mill is used in The Silesian University of Technology [28].

The LMOW-2x1 mill has the 200 kg weight, 400 cm³ and 1 dm³ chambers, 50÷500 g sample weight, 10÷16 Hz vibration frequency, 40÷200 rpm chamber

rotation speed, 0.75 kW power vibrator motor, 0.37 kW power chamber motor and cooling system.

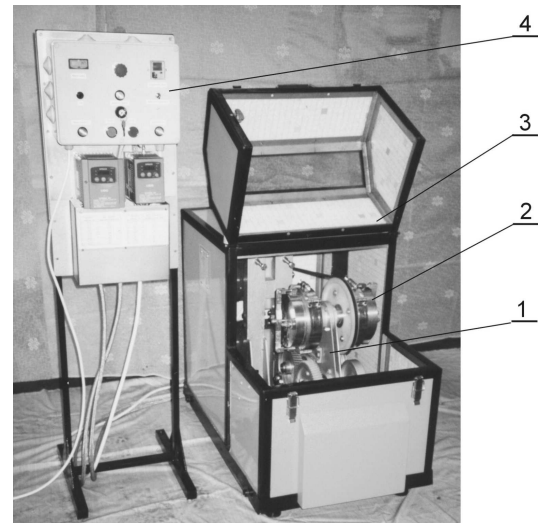

Fig. 12. Photo of laboratory rotary and vibratory mill LMOW-2x1 [28]: 1 – mill operational unit, 2 – chamber, 3 – casing, 4 – control and supply system

Chambers of these mills are adopted for milling in the argon atmosphere, without necessary application of a manipulation lock.

6. Production of amorphous and crystalline Ni₅₀Zr₅₀ alloy in rotary-vibratory mill in University of Science and Technology

In production of amorphous and crystalline Ni₅₀Zr₅₀ alloy was used the laboratory rotary-vibratory mill, type LAMOW-D-1/05 [13, 17]. The basic parameters of that mill were: vibration frequency 14 Hz, chamber angular speed 16,7 rad/s, diameter of ball 12 mm and alloy mass 50 g.

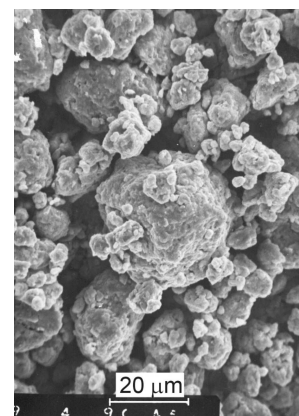

Fig. 13. Microscopic picture of the nickel and zirconium mix after 30 hours of the MA process

Fig. 13 shows the microscopic picture of the amorphous Ni₅₀Zr₅₀ alloy obtained in the AGH [13], and the

Fig. 14 shows the experimentally determined functions $P(r) = \rho(r)/\rho_0$, where $\rho(r)$ is a local atomic density in the “r” distance from particular atom, and ρ_0 – average atomic density for the tested $\text{Ni}_{50}\text{Zr}_{50}$ alloy after the defined milling time.

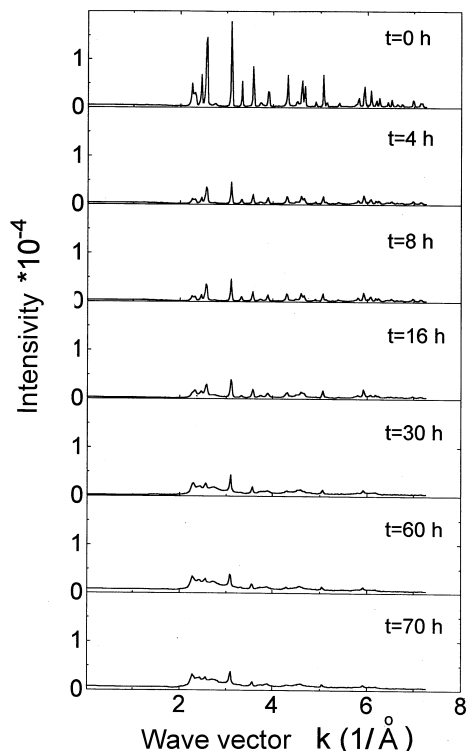

Fig. 14. Experimentally determined $P(r)$ function after 0–70 hours of the MA process

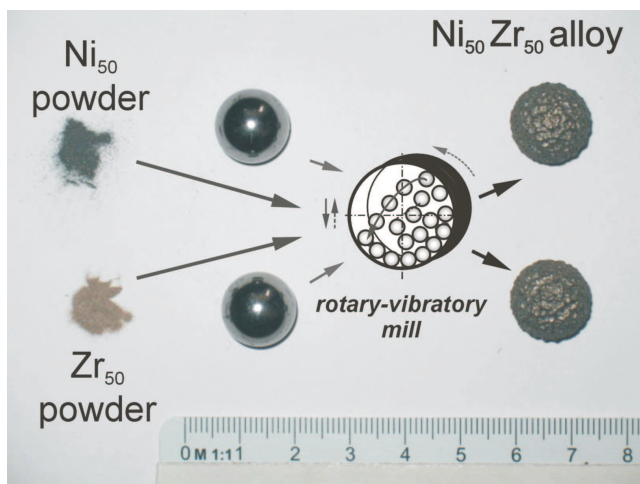

Fig. 15. Powders and crystalline alloys of nickel and zirconium obtained in the UST using the rotary-vibratory mill

Figure 15 shows examples of the $\text{Ni}_{50}\text{Zr}_{50}$ and Fig. 16 – Ni_{50} crystalline alloys obtained by the author using the rotary-vibratory mill. Each of the alloys was obtained in the room temperature form powders with

graining less than $40\ \mu\text{m}$ in the $100\ \text{cm}^3$ chamber. Alloys covered the balls and internal chamber surface.

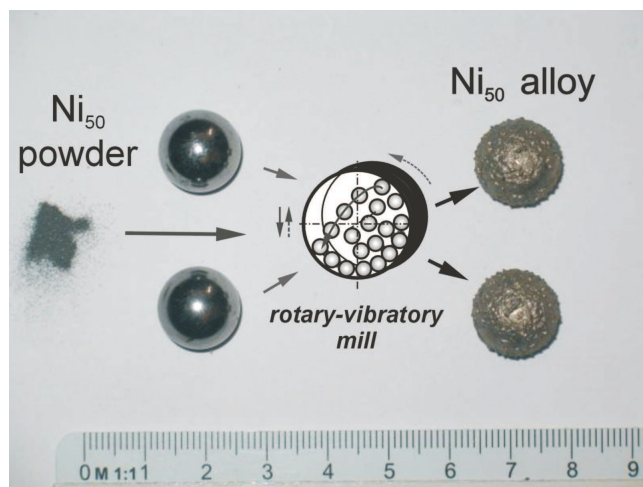

Fig. 16. Powder and crystalline alloy of pure nickel obtained in the UST using the rotary-vibratory mill

7. Summary

Mechanical methods are commonly used for production of metallic and ceramic-metallic nano-structures and amorphous materials. These methods commonly use the mechanical devices. These are the free grinding medium mills, characterizing with high grinding media energies. Most significant design differentiation occurs in the laboratory mills. Most frequently used laboratory mills are the planetary, vibratory, mixing, rotary-magnetic or impeller mills. In two domestic academic centers, AGH – University of Science and Technology and The Silesian University of Technology the original Polish rotary-vibratory mill designs were applied.

There was shown application MA in production of amorphous and crystalline $\text{Ni}_{50}\text{Zr}_{50}$ alloy and pure crystalline Ni_{50} in laboratory rotary-vibratory mill. These laboratory mills are characterizing with large research possibilities, high-technology potentials, low buying cost and low harmful effect to environment. These mills are suitable for all the mechanical production methods for metallic or ceramic-metallic nano-structures or amorphous materials. Their advantages are special chambers adopted to use without the argon lock (manipulation chamber) and the MA process realization time is very near to the times for the planetary, vibratory, mixing or impeller mills.

However three mill groups: gravitational, mixing and impeller type ones are used for an industrial scale. Best technological possibilities ensure the impeller mills in which the MA, HEBM or RM processes can be carried at very large temperature and pressure ranges inside the chamber.

REFERENCES

- [1] B h u s h a n, Handbook of Nanotechnology, Springer 2004.
- [2] M. J u r c z y k, Nanomateriały, Wyd. Politechniki Poznańskiej, Poznań 2002.
- [3] S. C h i c h e l n i c k y, Milling as a nanoparticle preparation technique, Ben-Gurion University of the Negev 2006.
- [4] M. J u r c z y k, Mechaniczna Synteza, Wyd. Politechniki Poznańskiej, Poznań 2003.
- [5] C. S u r y a n a r a y a n a, Mechanical alloying and milling, Progress in Materials Science **46**, 1-184 (2001).
- [6] M. L e o n o w i c z, Nanokrystaliczne materiały magnetyczne, WNT, Warszawa 1998.
- [7] R.Z. V a l i e v, R.K. I s l a m g a l i e v, L.V. A l e k s a n d r o v, Bulk nanostructured materials from severe plastic deformation, Progress in Materials Science **45**, 103-189 (2000).
- [8] K.S. S i o w, O.A. T a y, P. O r u g a n t i, Mechanical Properties of Nanocrystallite Copper and Nickel, Mat. Sci. Technn. **20**, 285-294 (2004).
- [9] S. N a z u, S. I m a o k a, S. M o r i m o t o, H. T a n i m o t o, B. H u a n g et al., Mössbauer study of mechanically alloyed powders, Osaka University, Faculty of Engineering Science, 1990.
- [10] J.S. B e n j a m i n, Mechanical alloying, Sc. American **234**, 40-57 (1976).
- [11] C.C. K o c h, The synthesis and structure of nanocrystallite materials produced by mechanical attrition, A Review, Nanostructured materials **2**, 109-129 (1993).
- [12] P. M a t t e a n z z i, G. L e C a è r, A. M o c e l l i n, Synthesis of Nanostructured Materials by Mechanical Alloying, Ceramics International **23**, 39-44 (1997).
- [13] L. D a r g e l - S u l i r, J. S i d o r, Otrzymywanie amorficznego stopu Ni₅₀Zr₅₀ techniką mechanicznego wytwarzania (MA) w młynie obrotowo-wibracyjnym, Inżynieria Materiałowa **5**, 1296-1301 (1998).
- [14] B.S. M u r t y, S. R a n g a n t h a n, Novel materials synthesis by mechanical alloying – milling, Inter. Mater. Reviews **43**, 101-141 (1998).
- [15] M. A b d e l l a o n i, E. G a f f e t, The physics mechanical alloying in a planetary ball mill: mathematical treatment, Acta metall. mater. **43**, 1087-1098 (1995).
- [16] T. T a n a k a, S. N a s u, K.H. I s h i k a r a, P.H. S h i n g h u, Mechanical alloying of high carbon Fe-C system, Journal of the Less-Common Metals, December 1990.
- [17] J. S i d o r, Badania, modele i metody projektowania młynów wibracyjnych, Rozprawy Monografie nr 150, UWND AGH, Kraków 2005.
- [18] J. S i d o r, Wyznaczanie parametrów ruchu mielników w młynie obrotowo-wibracyjnym za pomocą wizualizacji, Kraków, Problemy w Budowie i Eksploatacji Maszyn i Urządzeń Technologicznych, Problemy Inżynierii Mechanicznej i Robotyki, Wyd. WIMIR AGH, nr 23, 2004, pp. 173-181.
- [19] www.chembio.uoguelph.ca
- [20] www.dymatron.com/megamill
- [21] M. J u h n k e, R. W e i c h e r t, Erzeugung von Nanaopartikeln aus weichen Substanzen mit hohen Reinheitsanforderungen durch Zerkleinerungs, Technische Universität Clausthal, Institut für Verfahrenstechnik 2005.
- [22] www.fritsch.de
- [23] www.retsch.de
- [24] A. C a l k a, D. W e x l e r, D. O l e s z a k, J. B y s t r z y c k i, Formation of Amorphous and Nanostructural Powder Particles from Amorphous Metallic Glass Ribbons using Ball Milling and Electrical Discharge Milling, Solid State Phenomena Vols. 101-102, 111-116 (2005).
- [25] J. S i d o r, Opracowanie założeń, konstrukcji i wykonanie wysokoenergetycznego młyna typu atriyor, PNT Omega, Kraków 2000.
- [26] G. K a u p p, Waste-free large scale synthesis without auxiliaries for sustainable production omitting purifying workup, Journal CrystEngComm **8**, 794-804 (2006).
- [27] www.zoz.de
- [28] J. S i d o r, Opracowanie i wykonanie młyna obrotowo-wibracyjnego z możliwością pracy w trzech wariantach PNT Omega, Kraków 1999.