

J. NIAGAJ\*, Ł. MAZUR\*

## FERRITE CONTENT MEASUREMENTS IN S32101 LEAN DUPLEX STAINLESS STEEL AND ITS WELDED JOINTS

### POMIARY FERRYTY W STALI LEAN DUPLEX S32101 I JEJ ZŁĄCZACH SPAWANYCH

Due to their mechanical and plastic properties as well as unique corrosion resistance, two-phase lean duplex steels are increasingly popular in industrial applications e.g. for building waterside fixtures, ships, pipelines or containers. A critical factor of welded joints made of such steels is the balance between austenite and ferrite; the latter being measured by a special device called ferritoscope. The article contains the results of tests focused on measurements of ferrite content in S32101 lean duplex steel and its welded joints. The text also presents the impact of such factors as test sample thickness or shape and condition of measurement surface etc. on test results. In addition, this paper discusses the use of correction factors, describes problems arising during measurements of ferrite in welded joints and presents manners of the elimination of the latter. The conducted tests revealed that MAG method welding parameters affect the content of ferrite in butt welded joints produced with S32101 lean duplex steel.

*Keywords:* lean duplex, welded joint, ferrite measurement, ferrite content, MAG, GMAW

Dwufazowe stale typu lean duplex z uwagi na ich własności wytrzymałościowe i plastyczne oraz szczególną odporność korozyjną są coraz częściej stosowane w przemyśle do budowy armatury nadbrzeżnej, statków, rurociągów lub zbiorników. W złączach spawanych z tych stali bardzo ważna jest równowaga pomiędzy austenitem i ferrytem. Pomiary zawartości ferrytu wykonuje się za pomocą np. urządzenia typu ferrytoskop. W artykule przedstawiono wyniki badań zawartości ferrytu za pomocą ferrytoskopu w stali lean duplex S32101 i jej złączach spawanych oraz wpływ na wyniki pomiarów takich czynników jak: grubość mierzonej próbki, stan i kształt powierzchni pomiarowej itp. Omówiono stosowanie współczynników korekcyjnych. Wyszczególniono problemy powstające podczas wykonywania pomiarów ferrytu w złączach spawanych oraz sposoby ich niwelowania. Przeprowadzone badania wykazały, że parametry spawania metodą MAG mają wpływ na zawartość ferrytu w doczołowych złączach spawanych wykonanych ze stali lean duplex S32101.

### 1. Introduction

As is commonly known, duplex steels are two-phase stainless steels of ferritic-austenitic structure. The content of each of the phases ( $\alpha$  and  $\gamma$ ) in the structure of these steels is more or less equal and amounts to approx. 50%. The qualitative equilibrium between ferrite (phase  $\alpha$ ) and austenite (phase  $\gamma$ ) in duplex steels contributes to their higher strength and excellent corrosion resistance thus combining the advantages of both ferritic and austenitic stainless steels. [1÷4].

Welding processes, due to heating, melting and solidification of both parent and filler metals used for welding duplex steels, change the ferrite-austenite proportion not only in the weld but also in the heat affected zone (HAZ). Depending on welding conditions and parameters as well as the application or failure to a filler metal

(and its content) in the material of the newly formed weld, the ferrite-austenite proportion may change, which has its consequences in the modification of mechanical properties and corrosion resistance of welded joints. Due to the foregoing, the ferrite content in the material of welded joints made of duplex steels, including standard, super, hyper and lean duplex, should be from 30÷35 to 60÷65%, according to various publications the aforesaid range may be slightly wider or narrower as well as slightly shifted upwards or downwards, yet never outside the limits of the range 20÷70% (ferrite number approx. FN 30÷100) [5÷7].

The article presents the results concerning the determination of ferrite content in the parent metal and welded joints produced with lean duplex steel designated as S32101 according to the UNS (Unified Numbering System). If compared with standard duplex steels,

\* WELDING TECHNOLOGIES DEPARTMENT, INSTITUTE OF WELDING, 44-100 GLIWICE, 16-18 BŁ. CZESŁAWA STR., POLAND

lean duplex steels are characterised by lowered content of molybdenum and nickel, partially replaced by manganese.

## 2. Experimental procedure

Ferrite content measurements, in the parent metal were carried out using 6 mm and 12 mm-thick, 100×150mm-sized S32101 lean duplex steel samples. In the material of individual zones of welded joints, ferrite content measurements were carried out using 12mm-thick, 300×350 mm-sized S32101 lean duplex steel joints because in this joints high changes in ferrite content have been measured. The chemical composition of S32101 lean duplex steel and that of standard duplex steel (S32205), used for comparative purposes, is presented in Table 1. The MAG-welded test joints were produced with AVESTA LDX 2101 electrode wire ( $\emptyset$  1.2mm) of the chemical composition presented in Table 2; the shielding gas being Ar + 2.5 % CO<sub>2</sub> (designated as M12-ArC-2.5 according to PN-EN ISO 14175) and the forming gas being pure argon (designated as I1-Ar according to PN-EN ISO 14175). The test joints were

made using parameters, the selection of which ensured obtaining proper welded joints with both low and high amount of heat input (Table 3).

## 3. Results

### 3.1. Determination of ferrite content with FMP30 ferritoscope

The ferrite content in high-alloy stainless steels can be determined with various methods and measurement devices [8]. The tests in question involved the use of the most commonly industry-applied Fischer-manufactured ferritoscope FMP30 (Fig. 1) enabling the determination of ferrite content in steels, deposited metals and welds of welded joints having the composition of austenitic steels and that of austenitic-ferritic duplex steels as well as determining martensite content in austenitic steels [9]. The ferrite content can be expressed as a ferrite number (FN) or percentage. The tests were performed with the help of a measurement probe FGAB1.3-Fe of the measurement range 0.1-80% Fe (Fig. 1a).

Chemical composition of duplex steel plates applied in research

TABLE 1

UNS	Werkstoff number	Plate thickness, mm	Data source	Chemical composition, %								Ferrite content, %
				C	Si	Mn	Cr	Ni	Mo	Cu	N	
S32101	1.4162	6	certificate	0.028	0.70	4.90	21.34	1.50	0.19	0.25	0.21	56
S32101	1.4162	12	certificate	0.021	0.66	4.85	21.4	1.64	0.22	0.30	0.22	–
S32205/ S31803	1.4462	6	PN-EN 10088-2	max 0.030	≤ 1.00	≤ 2.00	21.0÷23.0	4.5÷6.5	2.50÷3.5	–	0.10÷0.22	–

Chemical composition of applied electrode wire AVESTA LDX 2101

TABLE 2

Diameter, mm	Data source	Alloying elements content, %									
		C	Si	Mn	P	S	Cr	Mo	Ni	N <sub>2</sub>	Cu
1.2	certificate	0.016	0.53	0.75	0.029	0.001	23.12	0.25	7.27	0.117	0.17

MAG method welding parameters of test butt joints of lean duplex S32101 steel plates of thickness 12 mm

TABLE 3

No.	Joint designation	Current intensity, A	Arc voltage, V	Travel speed, cm/min	Heat input, kJ/mm
1	D24	122	22.0	28.0	0.50
2	D26	126	22.0	11.1	1.20
3	D27	230	27.6	16.4	1.90
4	D28	224	28.8	6.7	4.60

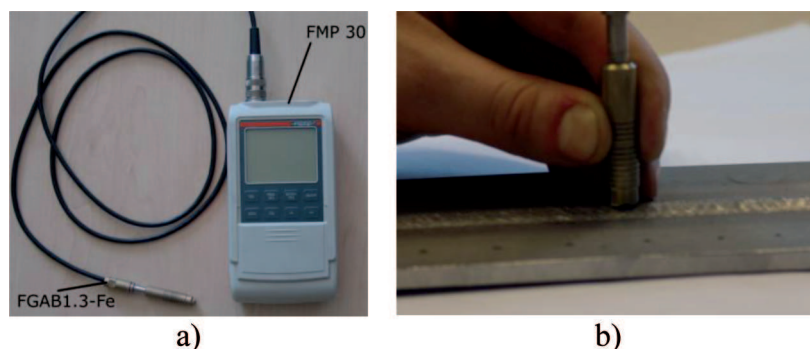

Fig. 1. Ferritoscope FMP30 with measurement probe (a) and ferrite content measurement from face of weld on experimental welding joint (b)

Pursuant to ISO 8249 [10] recommendations, the ferrite measurements were made at a minimum of 6 points on the surface of each test sample. Due to the fact that the ferrite content in S32101 lean duplex steel exceeds 20 FN, a minimum of 5 readings were made in each of the six measurement points, with the reading corresponding to the highest ferrite number value adopted as the FN measured value [10].

### 3.2. Ferrite content measurement in parent metal

#### a) impact of surface condition

It is commonly known [8] that ferrite content measurement results obtained with a ferritoscope are conditioned on the condition of a measurement surface (roughness, oxidation, presence of paint, varnish, rust or scale) and the thickness of a test sample. In order to determine the effect of these factors on test results, the tests were performed with 6 mm-thick S32101 steel samples of the surface a) in delivery condition; b) ground; c) painted. Comparative tests were conducted using 6- and 12 mm-thick S32101 steel samples and 6 mm-thick 2205 steel samples.

The tests of the 6 mm-thick S32101 steel samples revealed the lowest (approx. 30%) ferrite content in case of the samples with paint-covered surface (Fig. 2). In turn, the ferrite content revealed on the ground surface amounted to 47%, whereas that determined in the samples in delivery condition was only slightly lower and amounted to 45%. A similar dependence could be observed in case of 12 mm-thick S32101 steel samples (Fig. 3) and 6 mm-thick 2205 steel samples (Fig. 4). As a result, it is possible to draw a conclusion that the presence of non-magnetic substances (paint, oxides generated during production and storage of steel etc.) on the surface of tested objects reduces measurement results. The degree of the aforesaid reduction depends on the thickness of a non-magnetic layer; the presence of paint reduces measurement values by as much as 17% (Fig. 2), whereas the presence of a considerably thinner oxide lay-

er reduces measurement values by not more than 2÷4% if compared with those obtained from a ground surface (Fig. 2÷4).

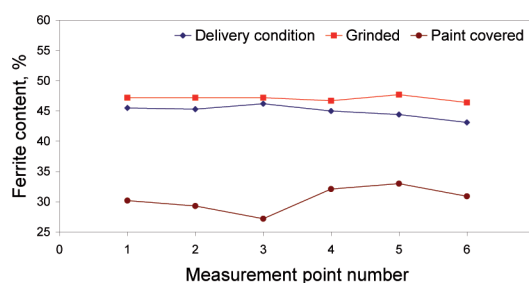

Fig. 2. Influence of surface condition on ferrite content measurement results in duplex steel S32101 of 6 mm thickness

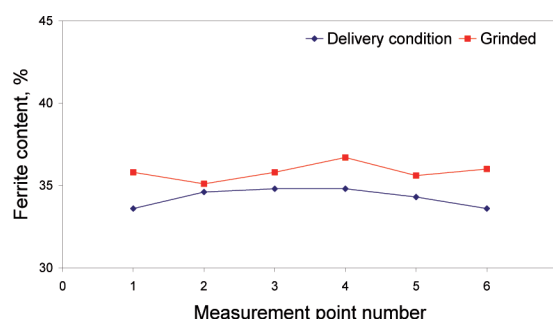

Fig. 3. Influence of surface condition on ferrite content measurement results in duplex steel S32101 of 12 mm thickness

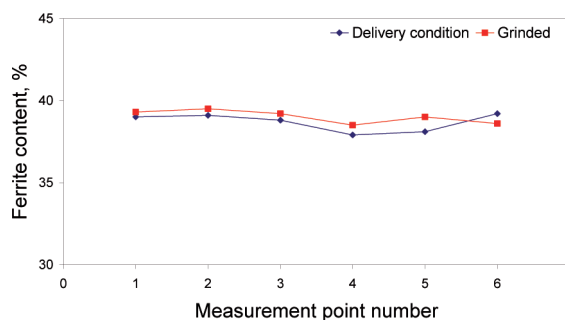

Fig. 4. Influence of surface condition on ferrite content measurement results in duplex steel S32205 of 6 mm thickness

In order to determine the dynamics of decreasing measurement value results in the presence of a non-magnetic layer, it was necessary to carry out a test, in which the thickness of the layer was simulated by placing the ferritoscope measurement probe at a specific height "a" over the sample surface within the 0-6 mm range (Fig. 5). The S32101 steel samples used in tests came from different heat melts characterised by different ferrite content measured on the surface of plates: A – approx. 48% and B – approx. 37%. In the tests it was determined that the air space between the tip of the measurement probe and the measurement surface significantly affects the result of ferrite content measurements (Fig. 6). In case of both samples, the distance of only 0.5 mm between their surface and the measurement probe decreased the measurement result by more than a half: from 48% to 22% (sample A) and from 37% to 15% (sample B). If the above results were to be adopted as final ones, at least the B-designated steel would have to be recognised as failing to meet the requirements from the ferrite content point of view, although, in fact, it is otherwise. Thus, the presented test results indicate the necessity of measuring ferrite content in steels but, first of all, in welded joints, prior to painting (if any) and following the removal of a thick oxide layer, including the post-weld temper; this being also indicated in EN ISO 15614 series standards regarding the qualification of welding technologies.

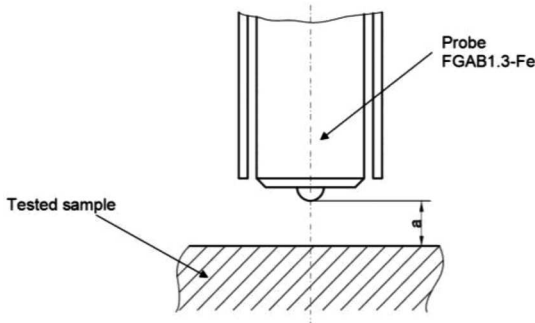

Fig. 5. Scheme of measurement probe location above the test sample surface

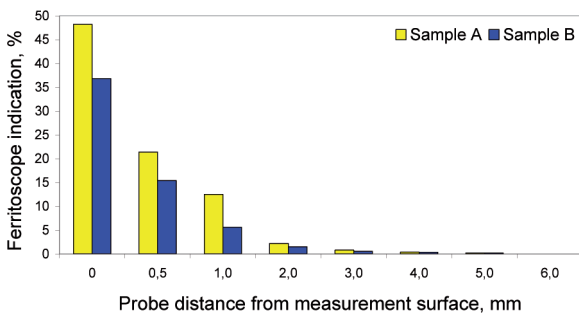

Fig. 6. Correlation between ferritoscope indication and distance "a" between measurement probe and samples A and B measurement surface of ferrite different content

During the tests it was also ascertained that the test sample affects the magnetic field of the measurement probe when the distance between the two does not exceed 5 mm (Fig. 6), yet the influence at such a considerable distance is slight and practically insignificant from  $a = 2\div 3$  mm onwards.

**b) impact of sample thickness**

The measurement result is also affected by the thickness of a measured element (detail, plate, weld) or applied layer e.g. the thickness of a duplex steel content surfacing layer on the surface of unalloyed steel. Figure 7b presents the results of measurements carried out on S32101 steel sample of strokly changing thickness from 6 to 1 mm (Fig. 7a). The measurements at the step of 1 mm thickness are characterised by approx. 7÷12% lower ferrite content if compared with the sample steps of thicknesses from 2 to 6 mm. The measurement results of the 2÷6 mm samples were between 52 and 56% and are similar to the ferrite content specified in the manufacturer's certificate of the tested S32101 lean duplex steel i.e. 56% (Table 1).

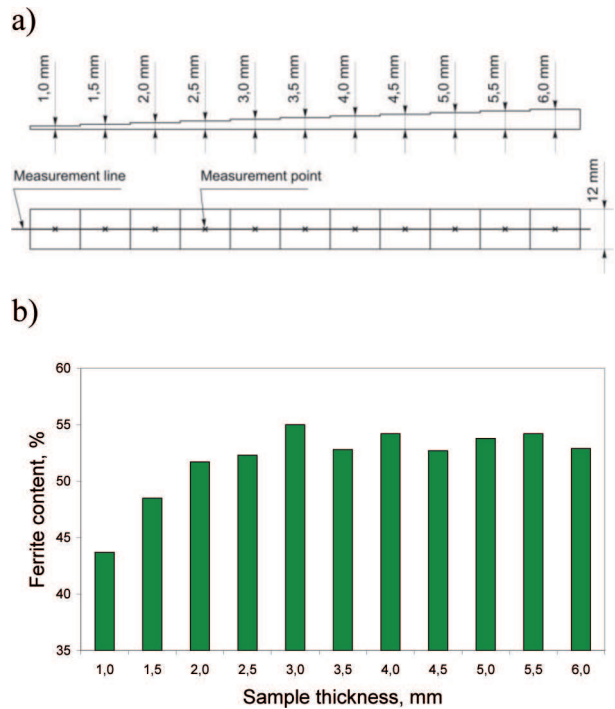

Fig. 7. Ferrite content measurement in lean duplex S32101 steel sample of strokly changing thickness: a) sample dimensions and measurement points location; b) ferrite content measurements results

The change of the thickness of a measured element, similarly as the radius of the curvature of the face or root reinforcement, can be recognised as the change of measured sample volume. The ferritoscope-based ferrite measurement in a sample of insufficient volume may lead to obtaining results with errors, which, in turn, might



lead to misinterpretation and incorrect conclusions related to the quality of a produced weld or padding weld. The tests made it possible to ascertain that in case of the steel samples of 50% ferrite content (duplex steels), approx. 98% of measurement quantity is obtained at the sample thickness of mere  $2\div 2.5$  mm (Fig. 7). One should, however, bear in mind that the magnetic field of the measurement probe influences the test material at the distance of up to 5 mm (Fig. 6), which could suggest, that ferrite content measurement results closest to real values will be those performed in welded joints of the minimum thickness of  $4\div 5$  mm.

On the basis of the above results of ferrite measurements conducted on the surface of samples at strokly changing thickness as well as on grounds of the tests focused on magnetic field influence it is possible to draw a conclusion that in case of S32101 lean duplex steel, correct results of measurements obtained with the FMP30 ferritoscope are obtained with the sample of a minimum thickness of  $2\div 2.5$  mm, which, to a significant extent, coincides with the ferritoscope manufacturer's recommendations stating that the minimum thickness of the sample or that of surfacing layer must not be less than 2 mm.

### c) impact of measurement point location

In addition to the thickness of test elements and non-magnetic layers covering the surface of test samples, other factors, such as the location of a measurement point, also influence ferrite measurement values. Presented below are measurement values of ferrite content on a ground surface and in the transverse section of two samples cut out of two S32101 steel plates coming from two different heat melts: A and B. During the tests it was determined that the ferrite content measured on the surface of the samples was approx. 48% in case of sample A and approx. 37% in case of sample B, whereas in case of the cross section the ferrite content was 54% and 52% respectively (Fig. 8). The difference between measurement values for individual samples depending on measurement point location varies and stands at approx. 6% in case of sample A and approx. 15% in case of sample B. It should also be noted that very similar, and also, in both cases, higher ferrite content values were obtained during measurements carried out on the transverse section surface of the samples: A – approx. 54% and B – approx. 52%. This fact could indicate that both the quantity of the aforesaid measurement differences and the higher ferrite content measurement results in the transverse section of the samples are influenced by the shape of grains and their linear packing resulting from plate rolling texture (Fig. 9). The magnetic interaction between thinner ferrite layers and the ferritoscope mea-

surement probe field differs from the interaction which can be observed in case of the absence of laminar packing of grains. In case of the structure characterised by the presence of thin ferrite layers, lower voltage is induced in the measurement coil, which, in turn, leads to the underrating of measurement results [11÷13]. A similar phenomenon can be observed in austenitic-ferritic steels.

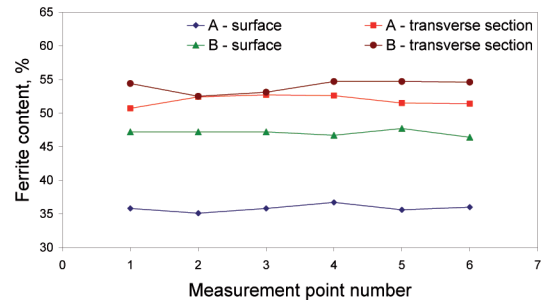

Fig. 8. Differences in ferrite measurements results on ground surface and in samples cross section area cut out of S32101 steel plates from different heat melts

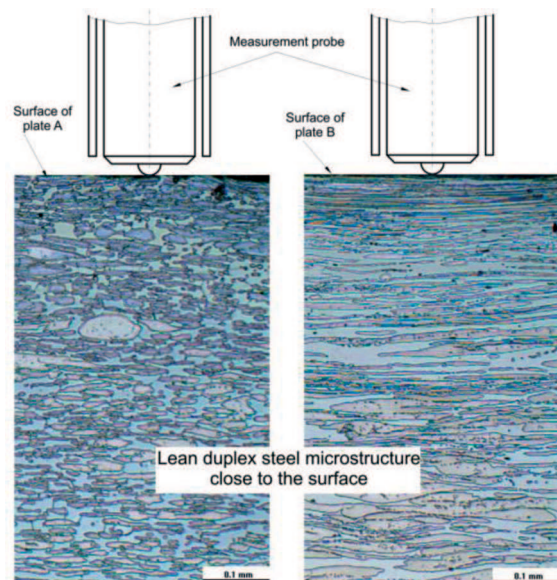

Fig. 9. Influence of shape and packing of austenite grains in lean duplex steels from both heat melts on ferrite measurement result on plate surface: A – 48%; B – 37%

The impact of rolling texture on ferrite content measurement results was particularly visible when, within further research, ferrite content was measured on the surface and in the transverse section of welds. The test revealed that in case of the welds, the differences resulting from the location of the measurement point (on the surface or in the cross section of the sample) are very insignificant and contained within a  $2\div 4\%$  range. The absence of considerable differences is probably attributable to the character of the structure of the welds, which is characteristic of a cast material characterised by the absence of clearly directed grains (Fig. 10).

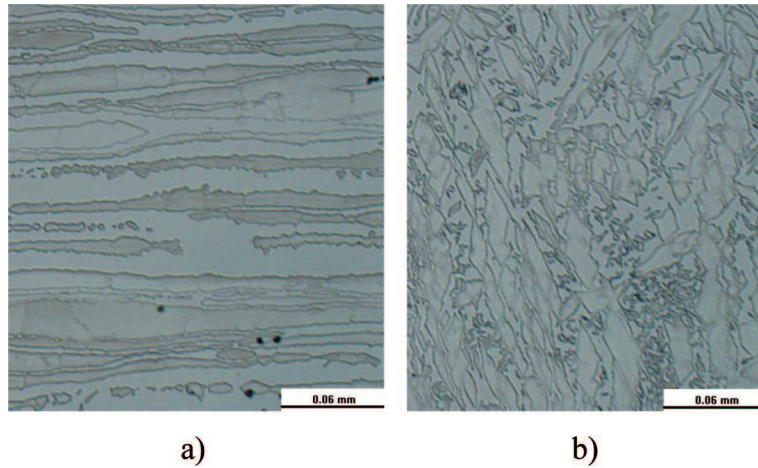

Fig. 10. Differences in areas microstructure of lean duplex S32101 steel weld joint of thickness 12 mm: a) parent metal; b) weld (magn. 200x)

A significant impact of rolling (grain strain) on the magnetic field between the ferritoscope and the measurement probe hinders the execution of proper ferrite content measurements and limits the possibility of comparing obtained results among one another in case of welded joints made of plates coming from different heat melts. Ferrite content measurements in the HAZ material (conditioned by the sufficient width of the heat affected zone – min. 2÷3 mm) and that in the parent metal can be compared only in case of one specific joint. As a result, one can determine the degree of increasing or decreasing ferrite content in the HAZ compared with the ferrite content determined in the parent metal.

#### 4. Ferrite content measurement in butt welded joints made of S32101 steel plates

During the ferrite content measurements conducted on the butt welded joints made of S32101 lean duplex steel plates (Table 3), ferrite content was measured on the level of their face and root following 45-minute chemical etching with the ANTOX 71E paste. Ferrite content measurements were made along the weld axis.

The MAG welding of the test joints made of 12 mm-thick S32101 lean duplex steel plates was connected with supplying various heat input (Table 3); the heat input being within the 0.5÷4.6 kJ/mm range (the steel manufacturer-recommended heat input being from 0.8 to 1.8 kJ/mm [6]). The welded joints made with S32101 lean duplex steel using the aforesaid heat input and similar surface condition revealed varied ferrite content (Fig. 11 and 12). The ferrite content measurements conducted on the face and root surfaces of the joints produced with low heat reveal higher values than the corresponding measurements carried out in the joints made with

a higher heat input. In case of 0.5 kJ/mm heat supply, the ferrite content in the weld, on the face and root side was within 40÷47%, whereas in case of 4.6 kJ/mm heat supply, the ferrite content was between 32 and 38% (Fig. 11 and 12). It should also be mentioned that in all of the cases the ferrite content was, in the weld material, slightly higher on the face side and slightly lower in the root side. The data presented in Figures 11 and 12 justify the conclusion that, irrespective of the

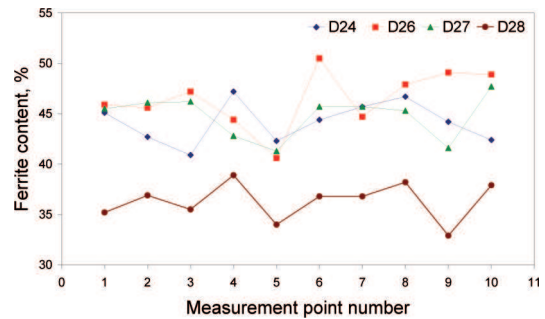

Fig. 11. Influence of heat input on ferrite content on weld face in test welded joints: D24, D26, D27, D28 (Table. 2) lean duplex S32101 plates of thickness 12 mm

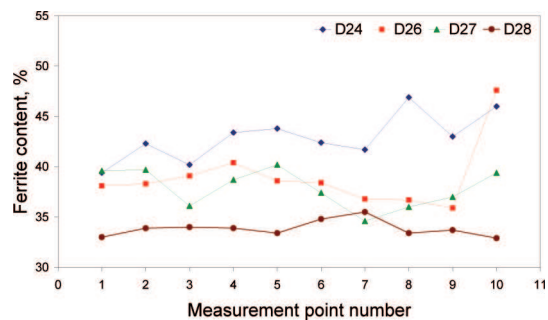

Fig. 12. Influence of heat input on ferrite content on weld root in test welded joints: D24, D26, D27, D28 (Table. 2) lean duplex S32101 plates of thickness 12 mm

location of a measurement point and the heat input supplied during MAG welding, the ferrite content in the material of the butt welds made of 12 mm-thick S32101 lean duplex steel plates was between 32 and 52%.

During the ferrite content measurements performed in welded joints by means of the FMP30 ferritoscope, the most significant problem was caused by a reinforcement present both on the face and root side of the weld. The convexity of the reinforcement is one of the cases of the change of the volume of material interacting with the measurement probe magnetic field; this being caused by the change of a curvature radius. The impact of the convex curvature radius can be eliminated by the application of appropriate correction factors without the necessity of removing the reinforcement. The values of the said coefficients depend not only on the geometry of samples or the distance between the measurement point and the edge of the sample but also on the ferrite content in an object under investigation. Measurements carried out on convex surfaces gain, whereas those performed on concave surfaces lose in value. Curvature radiuses affecting ferrite content measurements are smaller in duplex steels than in case of austenitic-ferritic steels [9].

In order to select a proper correction factor for ferrite content measurements conducted on the surface of face or root, it is necessary to determine a curvature radius e.g. by measuring the width and height of the face or root reinforcement. The values of correction factors can be obtained from appropriate graphs, depending on measured ferrite content and the value of a curvature radius; the aforesaid graphs are usually supplied by the device manufacturer usu. in manuals [9]. The selection of a proper coefficient is rather a time-consuming activity; this being due to changing joint lengths and reinforcement width and thus changing curvature radius and ferrite content values being the basis for the selection of a proper correction factor. In addition, the reading of correction factors from graphs is subject to inaccuracy caused by insufficient concentration of reference lines for individual curvature radiuses. The device manufacturer does not specify according to what rules one should select the correction factor for diameters, for which there are no reference lines on the diagram.

During measurements in points of varying width and height of weld face reinforcement or weld root reinforcement one should apply various values of correction factors. Unfortunately, the aforesaid manner of correction can be used only after completing measuring actions; this being due to the fact that one can enter (into a measurement device) only one corrective factor for a single measurement series [8, 9].

Figure 13 presents ferrite content values measured on the root surface prior to and following the removal of

the reinforcement. It was determined that the values of measurements performed on the convex surface of the root were by approx. 10% lower than those obtained after the removal of the reinforcement (after milling). The underrated measurement results are caused by the shape of the surface subject to measurement or, speaking more precisely, by too low metal volume affected by the magnetic field of the measurement probe. The application of appropriate correction factors caused that the post-weld ferrite content measurement conducted on the surface of the root was similar to the value of the measurement following the removal of the reinforcement (Fig. 13). The values of measurements made on the milled surface and those with the correction factors applied differ only by 2÷3%. Carrying out measurements one should remember that not only the shape of the face and root affects the results of ferrite content measurement in the weld but also the size and arrangement of the shell, which, similarly as the roughness of the sample surface, cause significant scatter of measurements conducted in one measurement point.

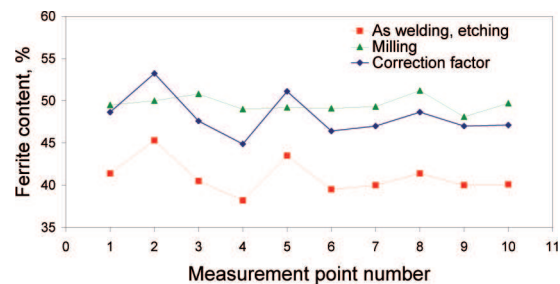

Fig. 13. Influence of root weld shape of S32101 steel and correction factor on measurement quantity of ferrite content

## 5. Discussion

The tests focused on the condition and shape of sample surfaces as well as on the procedure of measurement of ferrite content using the FMP30 ferritoscope equipped with the FGAB1.3-Fe measurement probe in S32101 lean duplex steel and its welded joints revealed a number of peculiarities which should be remembered while working on obtaining measurement results reproducing the real content of ferrite in a test material with the highest possible accuracy.

The tests revealed that the presence of paint on the surface of samples decreases measurement values by as much as 17% i.e. a fall from 47% down to 30% (Fig. 2). In turn, a thin layer of oxides present on the surface of plates in delivery state decreases the measurement result if compared with the results obtained from ground samples by mere 2÷4% (Fig. 2÷4), which in case of steel with 50% ferrite content has no significant impact on the



assessment of measurement results. A problem, however, may arise when the content of ferrite in the test steel is within the range of allowed boundary values [5÷7], and particularly around 30%. In the foregoing situation, a deviation of even a few percent may lead to an indication that a given steel does not meet related requirements. The tests simulating a non-magnetic layer on the plate surface revealed that the most significant decrease in obtained ferrite content results can be observed at the initial stage of increasing the distance between the measurement probe and the sample surface: in case of distance "a" equal only to 0.5 mm, measured ferrite content values decrease by more than a half (Fig. 6). In order to obtain accurate and reliable ferrite content data one should carefully prepare the measurement equipment (remove impurities or paint, or oxide layer) and, if in doubt, conduct additional tests applying a computer-aided analysis of a microstructural image [8].

One of the limitations accompanying ferrite content measurements with the FMP30 ferritoscope is the thickness of a test element or clad layer of austenitic steel or ferritic-austenitic steel composition produced on the surface of unalloyed steel. The tests revealed that in case of S32101 lean duplex steel, proper measurement results can be obtained with the sample thickness not less than 2÷2.5 mm (Fig. 7). Increasing the thickness of samples above 2÷2.5 mm leads to only a slight increase of obtained results, not exceeding 3÷4%. The most appropriate ferrite content measurement results are, however, obtained with the sample thickness of at least 4÷5 mm because, as it was previously determined, this is the distance of the magnetic field effect of the measurement probe applied (Fig. 6).

Moreover, the tests also revealed that, in addition to the condition of the surface and its thickness, also the position of the measurement point plays an important role. It was determined that in case of plates made of S32101 lean duplex steel coming from two different heat melts, the ferrite content measured in the transverse section was higher than that determined on the surface of the samples: approx. 54 and 48% in case of sample A, and 52 and 37% in case of sample B respectively (Fig. 8). As can be seen, in case of steel B the difference between measurement values amounts to approx. 15%. Such a significant difference could, in extreme cases, prevent further processing of a given steel plate. The metallographic examination showed that the microstructure of steels A and B differs significantly just below the surface of the plates (Fig. 9). Steel B has the structure characterised by grains elongated in the direction of rolling, which is highly possible to be responsible for inducing lower current in the measurement probe, which, in turn, translates to a lower ferrite content measurement

result. The aforesaid problems, however, do not occur in case of welded joints as welds are characterised by the structure typical of cast materials, in which, one does not usually observe clear elongation of grains depending on the position of the microsection plane (Fig. 10). Differences resulting from the place of measurement (on the surface or in the transverse section of welds) are usually contained within a 2÷4% range.

The primary purpose of the tests in question was to measure ferrite content in MAG-welded joints made of S32101 lean duplex steel. The tests revealed that the ferrite content measured both on the face and root surfaces of the weld made with a low heat input (approx. 0.5 kJ/mm) is between 40 and 47% and is higher in comparison with the results obtained with a relatively high heat input (approx. 4.6 kJ-mm), being between 32 and 38% (Fig. 11 and 12). It should be mentioned that in all of the test joints, ferrite content was slightly higher in the weld material on the face side than it was on the root side. According to the data presented in Figures 11 and 12, in case of MAG-method welding, irrespective of the place of measurement and the heat input in 0.5÷4.6 kJ/mm range, the ferrite content in the material of butt welds made of 12 mm-thick S32101 lean duplex steel plates is between 32 and 52% and thus is contained within the recommended range of values from 30÷35 to 60÷65% [5÷7].

During the ferrite content measurements performed in welded joints by means of the FMP30 ferritoscope, the most significant problem was caused by a reinforcement both on the face and root side of the weld, which through the change of the volume of the material interacting with the magnetic field of the measurement probe led to the underrating of measurement values. The impact of the convex curvature radius was eliminated either by milling or through the application of appropriate correction factors [9] without the necessity of removing the reinforcement. During the tests it was determined (Fig. 13) that the values of the measurements performed on the convex surface of the root were by approx. 10% lower than those obtained after the removal of the reinforcement (after milling). The application of appropriate correction factors caused that the post-weld ferrite content measurement conducted on the surface of the root was similar to the value of the measurement following the removal of the reinforcement. The values of measurements made on the milled surface and those with the correction factors applied differ only in 2÷3%. It should also be mentioned that while carrying out measurements on the surface of the face or that of the root one should also take into account the size and arrangement of the shell, which, similarly as the roughness of the sample surface,



cause significant scatter of measurements conducted in one measurement point.

## 6. Conclusions

As a result of the tests focused on ferrite content in S32101 lean duplex steel and its welded joints, performed by means of the FMP30 ferritoscope with the FGAB1.3-Fe measurement probe it was established that:

1. Proper preparation of a surface to be measured consisting in the removal of impurities, oxide layer, post-weld temper or paint as well as the application of proper correction factors while carrying out ferrite content measurements on the convex surface of the face or root of the weld enable obtaining measurement values which are very close to the real ferrite content measured in S32101 lean duplex steel and its welded joints; the differences with the actual state being not more than 2÷4%. The presence of paint on the measurement surface of failure to apply correction factors increases differences between measurement values by as much as 20%, which, in some cases, unacceptably distorts the actual ferrite content in test steel samples or welds.
2. Depending on a heat melt, ferrite content measurement values on the surface of the plate and in its transverse section may vary by up to approx. 15%, which is attributable to the packing of grains characteristic of rolling. In case of welds, the said differences amount to mere 2÷4%, which is the consequence of the formation of a structure typical of a cast material
3. During welding with the MAG method, irrespective of the place of measurement and the changing heat input varying between 0.5 and 4.6 kJ/mm, the ferrite content in the material of butt welds made of

12 mm-thick S32101 lean duplex steel plates is between 32 and 52% and is contained within the allowed range.

## REFERENCES

- [1] R.N. Gunn, Duplex stainless steel: microstructure properties and applications. Woodhead Publishing Ltd, England (1997).
- [2] R. Badjia, M. Bouabdallah, B. Bacroixa, C. Kahlouna, K. Bettaharc, N. Kherroubab, *Materials Science and Engineering A* **496**, 447-454 (2008).
- [3] J.W. Elmer, T.W. Eagar, *Welding Journal* **4**, 141-s-150-s (1990).
- [4] A. Baczmański et al., *Archives of Metallurgy and Materials* **53**, 1, 89-96 (2008).
- [5] Joint publication, How to weld Duplex Stainless Steel. Avesta Welding (2006).
- [6] Informative materials, Fabricating LDX 2101®. Rolled Alloys (2009).
- [7] NACE Standard MR0103-2007, Materials Resistant to Sulfide Stress Cracking in Corrosive Petroleum Refining Environments.
- [8] J. Niagaj, Ł. Mazur, *Bulletin of Polish Welding Institute* **4**, 49-59 (2010) (in Polish).
- [9] Sernice manual of ferritoscope FMP 30. Helmut Fischer GMBH (2008).
- [10] ISO 8249:2000 Welding – Determination of Ferrite Number (FN) in austenitic and duplex ferritic-austenitic Cr-Ni stainless steel weld metals (in Polish).
- [11] D. Jiles, *Introduction to magnetism and magnetic materials*. Taylor & Francis Group, (1998).
- [12] Joint publication, *Handbook of Magnetism and Advanced Materials*, John Wiley & Sons Ltd, England **1** (2007).
- [13] Joint publication, *Handbook of Magnetism and Advanced Materials*, John Wiley & Sons Ltd, England **2** (2007).