

M. URZYNICOK*, K. KWIECIŃSKI**, J. SŁANIA**

ANALYSIS OF PROBLEMS OCCURED DURING WELDING OF NEW GENERATION BAINITIC STEEL 7CrMoVTiB10-10 (T24)

PROBLEMY WYSTĘPUJĄCE PODCZAS SPAWANIA NOWEJ GENERACJI STALI BAINITYCZNEJ 7CrMoVTiB10-10 (T24)

A dynamic development of steels for components for use boilers used in fossil fired power plants creates new welding problems. Introduction of new combinations of alloying agents, which are used to improve mechanical properties, especially creep resistance, does not remain indifferent as to the weldability of the newest steels. Every new steel grade which will be used for pressure components in power plants boilers has to be precisely tested. The most important processes that require profound research are bending and welding. It is crucial to examine all new steel grades and use the knowledge to elaborate technologies which could be used during prefabrication and assembly of boiler installations. As an example 7CrMoVTiB10-10 also known as T/P24 is given.

Dynamiczny rozwój stali stosowanych w energetyce na elementy kotłów o parametrach nadkrytycznych stwarza nowe wyzwania spawalnicze. Wprowadzanie coraz to nowych kombinacji dodatków stopowych w celu osiągnięcia jak najlepszych właściwości mechanicznych w tym odporności na pełzanie nie pozostaje bez wpływu na spawalność nowych stali. Każda nowa stal, która zostaje zastosowana na elementy ciśnieniowe kotłów energetycznych musi przejść wiele prób, szczególnie jeśli chodzi o gięcie i spawanie aby możliwe było opracowanie technologii umożliwiających bezproblemowe wykonanie oraz montaż instalacji kotłowych. Przykładem takiej stali jest 7CrMoVTiB10-10 znana również jako T/P24.

1. Introduction

Present and constant trend towards reduction of production costs in energy generation is directly connected with the increase in the efficiency of power units at conventional power plants. Improvement of the efficiency can be reached through the increasing of main parameters, i.e. steam pressure and temperature. At present it is possible only if steam boilers are made of modern structural materials, which are able to withstand operational loads as well as provide high enough heat resistance in increased temperatures. Modern martensitic steels, such as E911 or P92 allow designing of power plants where superheated steam temperature of 625°C is applied. The increase in the steam pressure and temperature has a direct effect on the condition of the operation of membrane walls. Conventional materials like 16Mo3 or 13CrMo4-5 are not suitable for boiler walls for supercritical applications. Therefore the investigations on new steel grades of mechanical properties and creep strength that would enable them to be used as a component of a boiler working at very high temperatures have been initiated. In addition while developing those materials there were an idea to eliminate post-weld heat treatment during welding of thin-walled components (up to 10 mm) as in production conditions, especially in case of the walls, this treatment is difficult and expensive.

As the result of long-term research two new steel grades have been developed: 7CrWVMoNb9-6 (T/P23) in Japan as well as 7CrMoVTiB10-10 (T/P24) of Valloirec&Mannesmann consortium.

2. General Characteristic of Examined Steel

Basic chromium-molybdenum steel containing 2,25%Cr-1%Mo i.e. 10CrMo9-10 (T/P22) was developed nearly 60 years ago. Steel 10CrMo9-10 and 13CrMo4-5 were first so-called "genuine" steels with the increased creep strength. Originally those steels were designed for the long-term operation in the temperature up to 550°C and continual and failure-free operation for 250 000 h (over 30 years) of boilers made of those steels has been noticed.

The temperature of austenisation and the cooling rate as well as tempering conditions determine the structure and properties of steel in great measure. In chromium-molybdenum steels ferritic-perlitic (P22) and bainitic (P23 and P24) structures are most commonly obtained. Strengthened material with a predominance of bainite is characterised by the high creep strength, however it loses its strength more quickly than that with ferritic-perlitic structure due to lower structure stability [1].

* ZELKOT KOSZĘCIN, POLAND

** INSTITUTE OF WELDING, 44-100 GLIWICE, POLAND

Comparison of chemical composition of 2,25% Cr steels according to EN 10216-2 standard

Grade	Chemical composition, %									
	C	Si	Mn	Cr	Mo	Nb	Ti	V	B	W
T/P22	0.08-0.14	≤ 0.5	0.3-0.7	2-2.5	0.9-1.1	–	–	–	–	–
T/P23	0.04-0.1	≤ 0.5	0.1-0.6	1.9-2.6	0.05-0.3	0.02-0.08	–	0.2-0.3	0.0005-0.0006	1.45-1.75
T/P24	0.05-0.1	0.15-0.45	0.3-0.7	2.2-2.6	0.9-1.1	–	0.05-0.1	0.2-0.3	0.0015-0.007	–

T/P23 and T/P24 steels are another steel grade developed on the base of the steel containing 2% chromium with monitored alloying micro-additives amounts, which increase creep strength in the high temperatures. In case of P23 steel the molybdenum content has been significantly reduced and replaced with the highly carbide-forming elements, such as tungsten, vanadium and niobium. In P24 steel the content of molybdenum is on the same level as in P22 steel but it is enriched with the addition of vanadium, tungsten and boron which simultaneously influence the stabilisation of the structure. The carbon content is kept on very low level, what considerably improves the weldability and in theory makes possible to weld without preheating. The content of nitrogen has been reduced as well up to maximum of 0.01% in order to minimize the creation of the titanium nitrides.

Addition of titanium and boron in P24 steel has revealed certain problems with welding of this steel. Because of the high affinity of titanium for oxygen during welding processes those elements are being burnt out. This phenomenon has an adverse effect on the creep strength and properties of the weld. Table I shows the chemical composition of steels of 2,25% Cr group compared, while in Table II the mechanical properties of P22, P23 and P24 steels are given.

TABLE 3

Chemical composition of tested T24 steel grade

Grade	Chemical composition, %									
	C	Si	Mn	Cr	Mo	N	Ti	V	B	
T/P24	0,075	0,256	0,58	2,436	0,991	0,0082	0,087	0,235	0,0045	

The mechanical properties of T24 steel in the initial state are shown in Table IV.

TABLE 4

Mechanical properties of tested T24 steel grade in the initial state

Grade	Mechanical properties			
	Re, MPa	Rm, MPa	A min., %	HV
T/P24	500	608	21,5	208

TABLE 2

Comparison of the mechanical properties of 2,25% Cr steels according to EN 10216-2 standard

Grade	Mechanical properties								
	Re, MPa	Rm, MPa	A min., %		KV, J		R _{p0,2} , MPa		
			w	p	w	p	500°C	550°C	600°C
T/P22	280	480-630	22	20	40	27	180	–	–
T/P23	400	510-740	20	18	40	27	330	299	266
T/P24	450	565-840	17	15	40	27	324	301	248

3. Subject of research

Subject of research was the tube \varnothing 44.5×7.1 mm and 7CrMoVTiB10-10 (T24) grade. The chemical composition is shown in Table III.

4. Welding consumables

Selection of welding consumables is determined by the chemical composition of parent metal and working conditions of a joint. Welding consumables used in welding should ensure chemical composition of a weld and its mechanical properties as similar to that of parent material as possible.

Research conducted by producers of welding consumables for welding of T/P24 steel has revealed that while using filler metal of chemical composition similar to that of the welded steel the weld has been obtained which fulfils all mechanical criteria except for creep strength one. Titanium out of control burning out during welding process had direct and adverse effect on the weld. The weld differed considerably in respect of titanium content from the parent metal. The problem has been solved by the replacement of titanium with other alloying element, which has definitely lower affinity for oxygen and improved creep resistance of the material. This element is niobium. While comparing the chemical composition of the steel and filler metal one can notice that the content of titanium in the filler metal has been reduced to the level 0.0002% from initial 0.087%. Introduced niobium content has amounted to 0.052%.

Test welded joints were produced using BÖHLER filler rod P24-IG of 2.4 mm in diameter. Chemical composition is given in Table V and list of mechanical properties is shown in Table VI.

TABLE 5

Chemical composition of welding consumable used during research

Grade	Chemical composition, %								
	C	Si	Mn	Cr	Mo	Nb	Ti	V	B
W ZCrMo2VNb	0,11	0,19	0,55	2,48	0,91	0,052	0,0002	0,221	0,0001

TABLE 6
Mechanical properties of welding consumable used during research

Grade	Mechanical properties			
	Re, MPa	Rm, MPa	A min., %	KV
W ZCrMo2VNb	500	600	17	100

5. Welding process

The joint has been prepared as in Fig. 1. One root and two filling runs as well as a face of the weld has been done during welding process as in Fig. 2. As a shielding gas Argon 4.8 was applied. The trials were performed in H-L045 position. Prior to welding the joints under testing were heated up to the temperature approximately 150°C. No postweld heat treatment was performed.

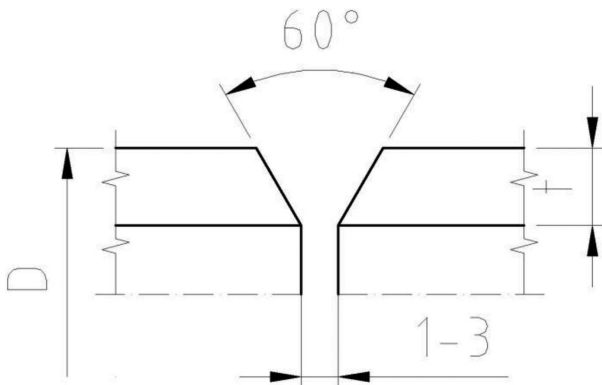

Fig. 1. Preparation of welding groove

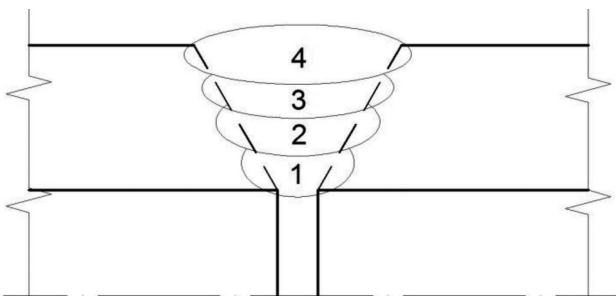

Fig. 2. Sketch of the joint

6. Plan of investigation

After the welded joints were produced the non-destructive testing, i.e.: VT, PT and RT was conducted. Testing was performed with the reference to the level B in accordance with

PN-EN ISO 5817 standard. Once the positive results of NDT were obtained, specimens were taken from the joints for mechanical testing as shown the diagram in the Fig. 3.

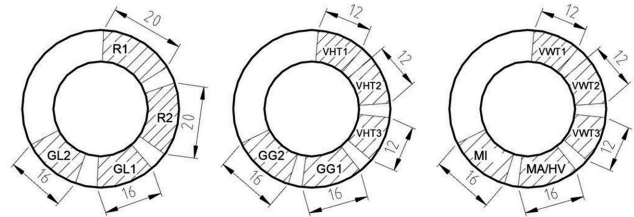

Fig. 3. The manner of cutting out of specimens from butt welded joints of tubes

The scope of mechanical testing included:

- static tensile test of welded joint (specimens R1 and R2),
- bend test (bending from face side GL1 and GL2 as well as root side GG1 and GG2),
- impact test (specimens VWT1÷VWT3 – notch in the weld; specimens WHT1÷WHT3 – notch in HAZ),
- macroscopic examination (specimen MA),
- microscopic examination (specimen MI),
- hardness measurements (specimen MA),

7. Results of tensile strength test

Testing was conducted in order to determine tensile strength of a weld (R_m) and verify the results considering the required minimum R_m for parent material (PM), which is 565 MPa according to the PN-EN 10216-2 standard. This value is marked with heavy line in the diagram (Fig. 4). Research has revealed that all welded joints broke outside the weld, thus have met the strength requirements.

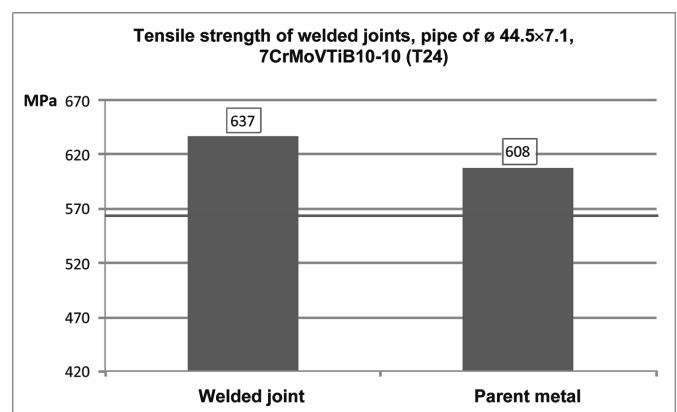
Fig. 4. Results of tensile test of butt welded joints of tubes of $\phi 44,5 \times 7,1$

8. Results of impact test for weld and HAZ

Testing was conducted in order to determine the impact strength values for the weld and HAZ. Acceptance criteria imposed in PN-EN 12952-6 standard determine minimum impact value for samples of standard section (10×10 mm) in HAZ on the level of 24J in room temperature, while standard PN-EN 10216-2 determines minimum impact value for PM on the level of 27 J. Those values are marked with the heavier line (Fig. 5).

Results of the impact values in a weld and the HAZ are higher than those required by standards mentioned above, as testing was conducted on the specimens of smaller section (5×10 mm). The results shown in Fig. 5 are in fact in the conformity with current guidelines according to impact testing of samples of smaller sections, i.e. they are proportionally (two times) higher.

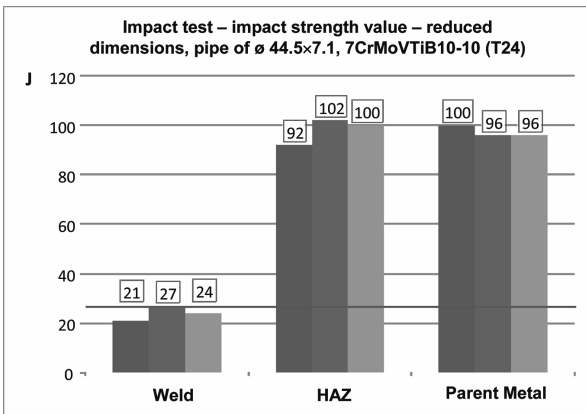

Fig. 5. Impact strength of weld metal in butt welded joints of T24 steel in tubes of $\phi 44.5 \times 7.1$

9. Results of bend test

Bend test with tensioning of weld face and root was performed in accordance with PN-EN 15614-1 [10] and PN-EN 910 [11]. Standard provision states that acceptance criteria is to obtain the bend angle of 180° without scratches and fractures on the stretched surface of the specimen. The results of testing (Fig. 6 and 7) meet the guidelines of the standard.



Fig. 6. Results of bend test – face of weld



Fig. 7. Results of bend test – root side

10. Results of hardness measurements of welded joints

Hardness measurements were conducted in accordance with PN-EN 15614-1 and PN-EN 12952-6 standards. Maximum hardness in the above mentioned standards for joints in T24 steel not subjected to heat treatment is not specified. Therefore in the testing the criterion as for 6th materials group subjected to heat treatment, i.e. maximum 350 HV10, was adopted. The distribution of hardness measuring points is shown in Fig. 8 and the results of the measurements are given in Fig. 9. All results are lower than limits, but it should be noticed that the hardness of the weld in the root area is almost the same as that in HAZ in the face side. It may signify that the weld is hardened in the result of backing gas stream influence which caused quicker cooling of the weld comparing to next runs (layers).

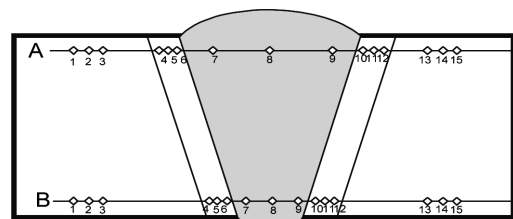

Fig. 8. Hardness measuring points in butt welded joints

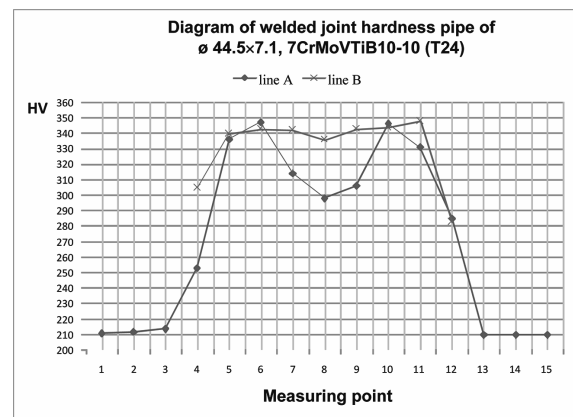

Fig. 9. Results of hardness measurement of butt welded joints of T24 tubes

11. Results of macroscopic examination

The testing was conducted in accordance with PN-EN 1321 standard. The quality level B according to PN-EN ISO 5817 standard was accepted as an assessment criterion. It was met by testing samples. Fig. 10 shows the result of macroscopic examination which is a photograph of a macrostructure of TIG welded butt joint.

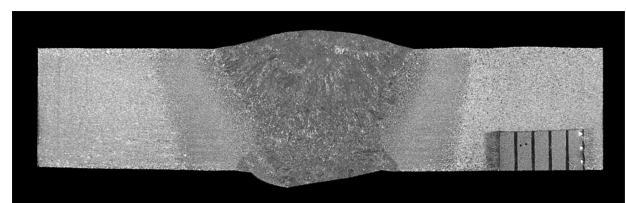
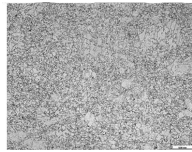
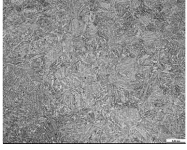
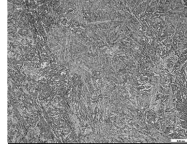

Fig. 10. Macrostructure of butt welded joint; etching: Nital; magnification: 1x; quality level: B

TABLE 7

Examples of result of microscopic examination of butt welded joint in T24 steel pipe of $\phi 44.5 \times 7.1$

parent metal – zone a ; etching: Nital; magnification 200x, bainite			
heat affected zone zone b ; etching: Nital; magnification 200x, bainite + martensite		weld zone c ; etching: Nital; magnification 200x, bainite + martensite	

12. Results of microscopic examination

The testing was conducted in accordance with PN-EN 1321 standard. Testing results have revealed no micro-fractures and confirmed proper microstructure in all zones of butt joint in T24 steel. Areas of microscopic examination are shown in Fig. 11 while Table 7 gives the results of microscopic examination in the form of photographs and descriptions of structures existing in the characteristic zones of welded joints.

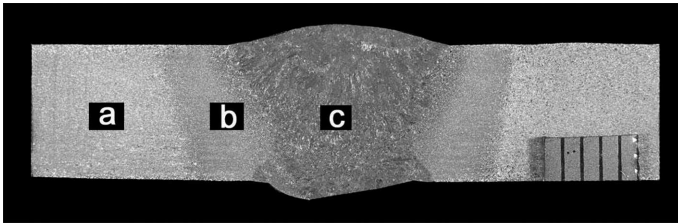

Fig. 11. Places of microscopic examination in butt welded joint in T24 steel pipe of $\phi 44.5 \times 7.1$

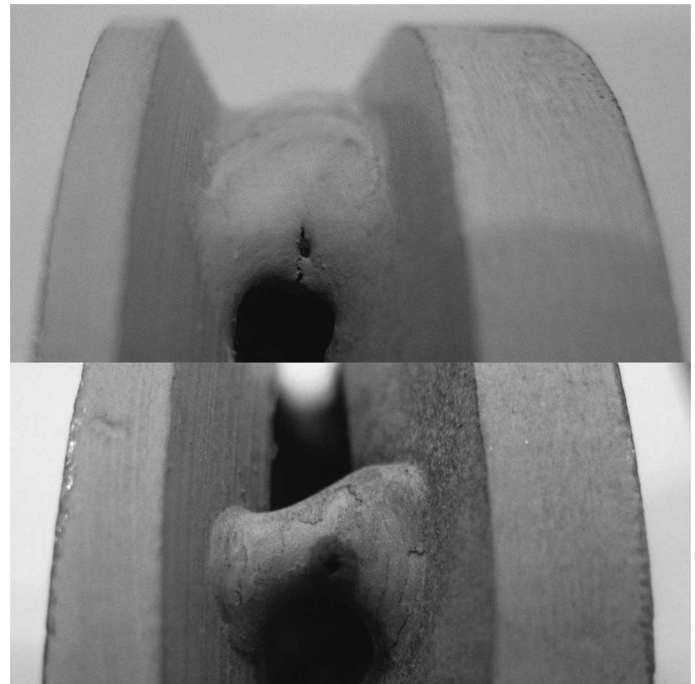

Fig. 12. Crack in weld crater and in tack weld

13. Problems while welding

The producer provides information that there is no need to preheat material prior to welding. Unfortunately the lack of preheating caused that in case of this research it appeared cracking in tack welds as well as in a crater. Elimination of those imperfections by grinding requires large amount of work and increases the time of joint production. Preheating up to the temperature approximately 150°C eliminated the problem of cracking occurrence. Welded joints produced without preheating are shown in Fig. 12 while Fig. 13 illustrates the joint made with preheating prior to welding.

Another problem noticed during research was significant oxidation of weld root which had similar character to that of austenitic steel welding. Producer of welding consumables for welding of T/P24 fails to provide information about the need of gas application in order to protect weld root during welding but such a shield was indispensable in the discussed case. A sample of weld produced without shielding gas is shown in Fig. 14 while weld root already shielded with argon is given in Fig. 15.

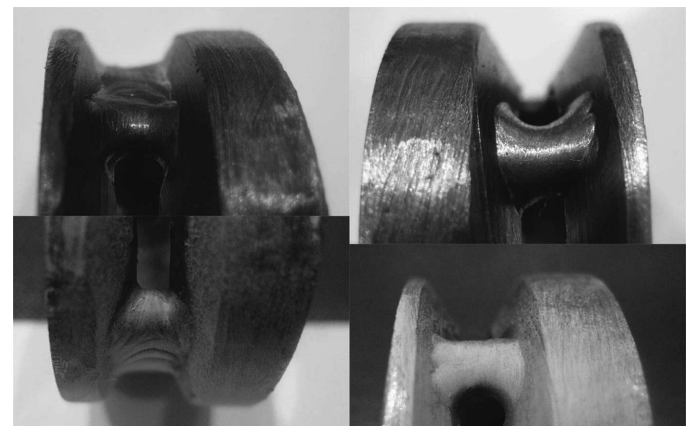

Fig. 13. Elimination of cracks by applying pre-heating to temperature of 150°C

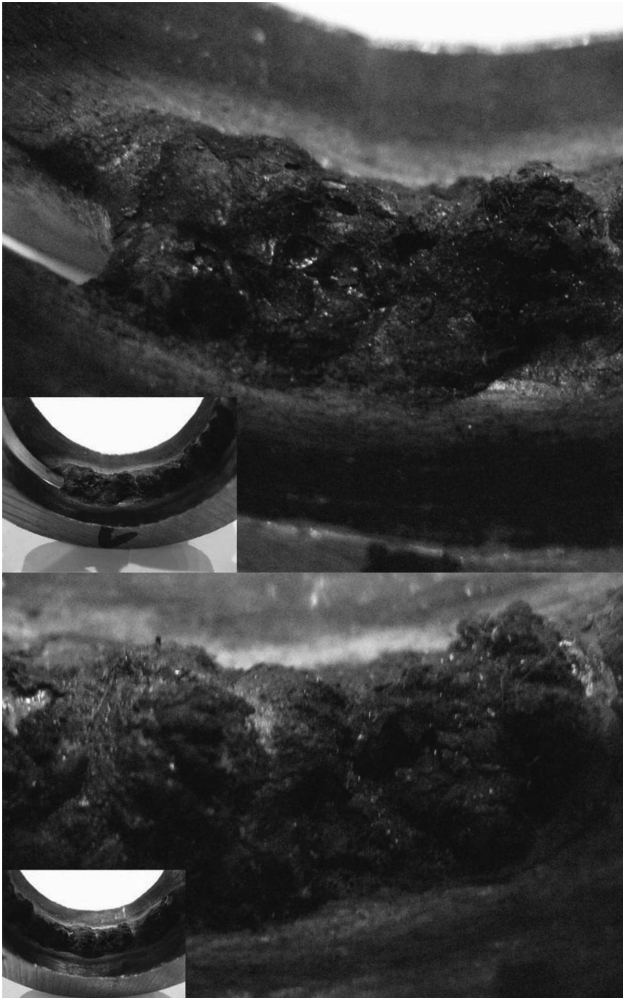

Fig. 14. Root weld without backing gas

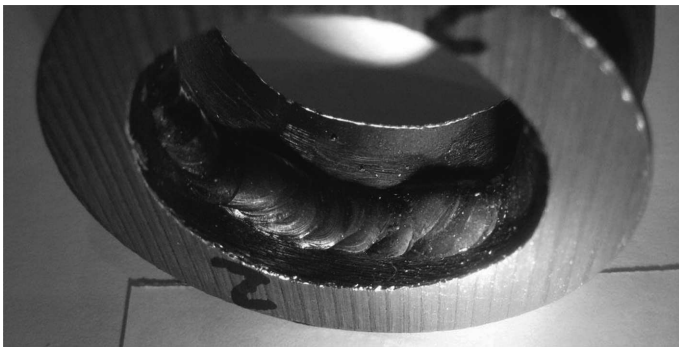

Fig. 15. Root weld with backing gas

14. Conclusions

1. Butt welds of $\phi 44.5 \times 7.1$ tubes and 7CrMoVTiB10-10 (T24) steel grade welded in position H-L045 are of high quality, which confirmed by non-destructive and mechanical testing.
2. Welding process of T24 steel causes more difficulties for welder than in case of welding in 10CrMo9-10 or even

VM12-SHC steels. The explanation of this fact is that viscosity of molten metal of the weld causes significant difficulties in its distribution in a weld groove.

3. Information provided by the producer about the lack of need for preheating is a matter for discussion.
4. Research have revealed that the application of shielding gas is necessary due to the considerable oxidation of the weld root not shielded with backing gas.

REFERENCES

- [1] A. Hernas, Żarowytrzymałość stali i stopów, Wydawnictwo Politechniki Śląskiej, Gliwice 1999.
- [2] Praca zbiorowa pod redakcją prof. dr hab. inż. J. Pilarczyka: Poradnik inżyniera – spawalnictwo, Tom 1, WNT, Warszawa 2003.
- [3] J. Brózdka, Wytoczne spawania i obróbki cieplnej stali do pracy w podwyższonych temperaturach, Wydawnictwo Instytutu Spawalnictwa, Gliwice 1990.
- [4] J. Adamczyk, K. Szkaradek, Materiały metalowe dla energetyki jądrowej, Wydawnictwo Politechniki Śląskiej, Gliwice 1992.
- [5] R. Pasierb, Spawanie żarowytrzymałych stali chromowo-molibdenowo-wanadowych, WNT, Warszawa 1982.
- [6] A. Klimpel, Technologia spawania i cięcia metali, Wydawnictwo Politechniki Śląskiej, Gliwice 1997.
- [7] J. Pilarczyk, Spawanie i napawanie elektryczne metali, Wydawnictwo Śląsk, Katowice 1996.
- [8] V. Shankar, A. Bhaduri, B. Raj, Welding Technology for Engineers, Alpha Science International, 2006.
- [9] L.A. Dobrzański, Metalowe materiały inżynierskie, WNT, Gliwice-Warszawa 2004.
- [10] A. Strang, i inni, Parsons 2000 Advanced materials for 21st century turbines and power plants, IOM Communications, London 2000.
- [11] F. Schubert, Deformation mechanism in Ni-base alloys, Seminarium zorganizowane przez Rafako S.A. i PTS, Rudy 16.04.2008.
- [12] M. Urzyniok, M. Szubryt, Optymalizacja czasu wykonania połączeń doczołowych rur kolektorowych dla przemysłu energetycznego ze stali 16Mo3, XVI Międzynarodowa Konferencja „Spawanie w energetyce”, Jarnołtówek 23-25.04.2008.
- [13] J. Pasternak, S. Fudali, Własności oraz doświadczenia w spawaniu stali przeznaczonych na elementy ciśnieniowe kotłów o parametrach nadkrytycznych, XVI Międzynarodowa Konferencja Spawanie w Energetyce, Opole-Jarnołtówek 2008.
- [14] H. Heuser, C. Jochum, Alloy design for similar and dissimilar welding and their behaviours.
- [15] M. Urzyniok, M. Szubryt, Zastosowanie nowoczesnych odmian metody mag do spawania rur kolektorowych w energetyce zawodowej, XV Seminarium Naukowo-Techniczne Badania materiałowe na potrzeby elektrowni i przemysłu energetycznego, Zakopane 18-20.06.2008.
- [16] T. Węgrzyn, J. Piwnik, Low alloy welding with micro-jet cooling, Archives of Metallurgy and Materials **2**, 57, 1 (2012).
- [17] T. Węgrzyn, R. Wieszała, Main Alloy Elements in Steel Weld Structures of Car Body, Archives of Metallurgy and Materials **1**, 57, 2 (2012).