

R. KACZOROWSKI\*, P. JUST\*, T. PACYNIAK\*

## DUCTILE CAST IRON OBTAIN BY LOST FOAM PROCESS AND INMOLD METHOD

### WYTWARZANIE ODLEWÓW Z ŻELIWA SFEROIDALNEGO W TECHNOLOGII INMOLD I LOST FOAM

This paper presents a technology of ductile cast iron obtain by lost foam process with use of in mold method. Spheroidization was carried out using master alloy in an amount of 1.5% by mass on casting iron.

Research the influence of the gating system configuration and the shape of the reaction chamber, the degree of spheroidization cast iron, which estimated based on the shape of the graphite. Research have shown that the greatest impact on the degree of spheroidization has cast the infusion position relative to the casting inlet and the reaction chamber, and the shape of the reaction chamber.

*Keywords:* nodular cast iron (ductile cast iron), in mold method, lost foam casting, innovative casting technologies, reaction chamber

W pracy przedstawiono technologię otrzymywania odlewów z żeliwa sferoidalnego metodą in mold z wykorzystaniem procesu pełnej formy. Sferoidyzację prowadzono z użyciem zaprawy sferoidyzująco-modyfikującej w ilości 1,5% na masę sferoidyzowanego żeliwa.

Przeprowadzono badania wpływu konfiguracji układu wlewowego oraz kształtu komory reakcyjnej na stopień sferoidyzacji żeliwa, który określono na podstawie wskaźnika kształtu grafitu. Badania wykazały, że największy wpływ na stopień sferoidyzacji żeliwa ma położenie wlewu doprowadzającego względem odlewu i komory reakcyjnej, oraz kształt komory reakcyjnej.

#### 1. Introduction

The world interest in the lost foam process started in the eighties of the twentieth century when the technological development enabled using the process for mass production of highly precised and dimensionally accurate casts from non-ferrous and ferrous alloys. A lot of interest in this technology of cast-moulding is caused by lower production costs and investments in comparison to the conventional method [1].

In mold method has been developed by International Mechanics Metal, out of all commonly known methods of production of nodular cast iron, the In mold method is one the most "elegant" and environmentally-friendly. Only a small amount of magnesium master alloy is consumed, guarantees the largest magnesium yield (70÷80%) out of all known cast iron spheroidization methods while its reaction with molten cast iron is almost smokeless [2] metal. In mold method consists in placing a portion of a spheroidising and modifying master alloy in a reaction chamber which is a part of the mould gating system [3]. In the research on in mold method carried out in the traditional technology it was found that a spherical reaction chamber provides the largest nodular graphite precipitates yield [4].

The presence of the reaction chamber in the gating system in the mould neutral plane is related with limitations in terms of location and configuration of casting feeding. As a result, use of in mold spheroidization in the lost foam casting process, where such limitations do not occur, seems reasonable, as this method lacks neutral area of the mould [5, 6]. Therefore it appears advisable to investigate the effect of the gating system configuration and the shape of the reaction chamber, the degree of spheroidization cast iron, which estimated based on the shape of the graphite. Studies have shown that the greatest impact on the degree of spheroidization has cast the infusion position relative to the casting inlet and the reaction chamber, and the shape of the reaction chamber.

#### 2. Research methodology

In this paper presents the results of the research on influence of the gating system configuration and the shape of the reaction chamber, the degree of spheroidization cast iron, which estimated based on the shape of the graphite. Ductile iron castings were obtain by lost foam process with use of in mold method. Spheroidization was carried out using master alloy in an amount of 1.5% by mass on casting iron.

\* DEPARTMENT OF MATERIALS ENGINEERING AND PRODUCTION SYSTEMS, ŁÓDŹ UNIVERSITY OF TECHNOLOGY, STEFANOWSKIEGO 1/15 ST, 90-924 ŁÓDŹ, POLAND

In order to investigate the effect of feed and discharge iron casting of the configuration of the reaction chamber proposed test cast (Fig. 1).

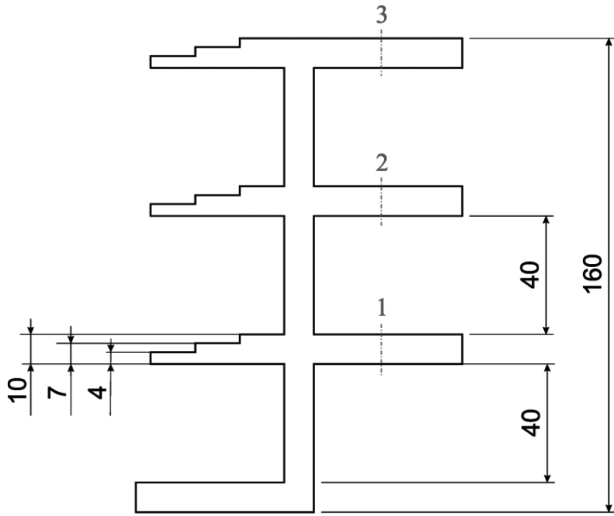

Fig. 1. Scheme of the test casting with marked sampling sites (the red dotted line): 1, 2, 3 – numbers of samples in test cast

The test cast was in the form of a tree with three levels of (low part – 1, middle part – 2, top part – 3 – shown in Fig. 1). He had a cross section of 1.5 cm<sup>2</sup> and the cast of variable cross-stepped, which retains its constant width, and there were three of 4 mm, 7 mm and 10 mm. For this proposed test cast gating system was designed. The experimental casting set contained a sprue (WG), ingate (WD), the reaction chamber (KR) and two test castings.

After calculating the amount of sprue and sizing sections of the gating system components, the volume of the reaction chamber was calculated, with a view to that contained in the master alloy was filled with 50% by volume. Research was carried out using two types of reaction chambers with the same volume but different dimensions: the first low (marked as N) 40×40×30mm, the second high (marked as W) 30×30×54mm.

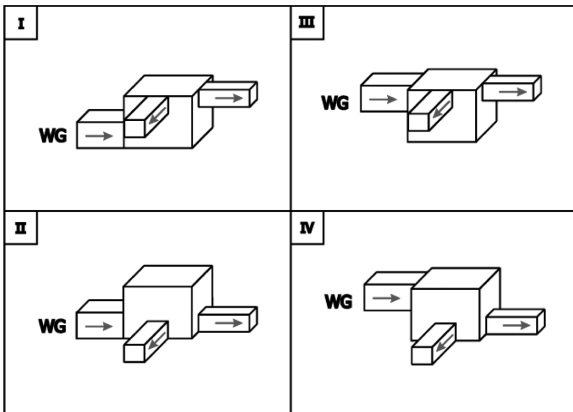

Fig. 2. Feed configuration–reaction chamber low (N)

For each type of reaction chamber were tested four different inlet and outlet configurations. The each of experimental casting set contained two test castings, supplied from the reaction chamber in such a manner that: one was in straight line with the flow direction of liquid cast iron to the reaction chamber (referred to as P), a second lateral – offset 90° relative

to the flow direction of liquid cast iron the reaction chamber (referred to as B).

Variants of test casting configuration used in studies (referred as I, II, III, IV) are shown: for the low reaction chamber in Figure 2, and for the high reaction chamber in Figure 3.

The arrows in Figures 2 and 3 indicate the flow direction of liquid iron through the reaction chamber.

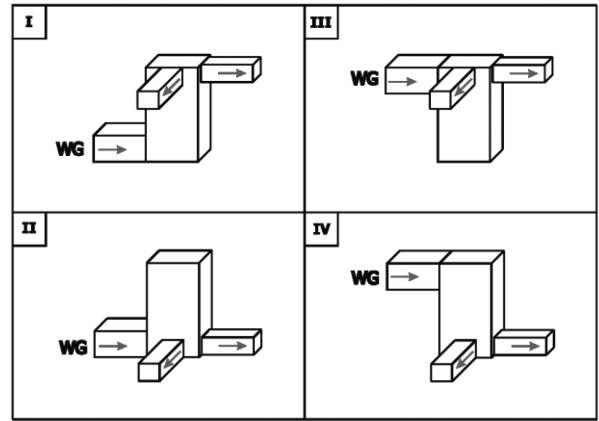

Fig. 3. Feed configuration – reaction chamber high (W)

### 3. Results and discussion

The resulting castings were macroscopic evaluation. On this basis, there was no casting defects. All castings were received correctly mapped and have sharp edges, even in places where the wall thickness was 4 mm (Fig. 4). Configuration the position of the reaction chamber and its size did not affect the reproduction of the mold cavity.

In this case, the most affected cross section and the height of sprue.

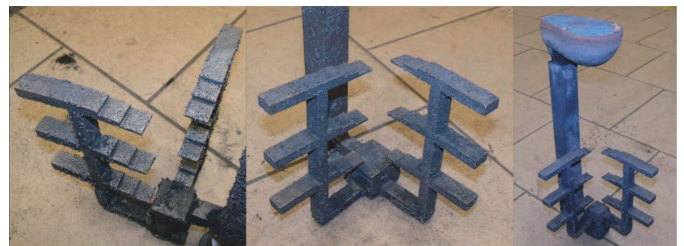

Fig. 4. Ductile cast iron obtain by lost foam process with use of in mold method

Specimens for microstructure analysis have been collected from the test castings according to figure 1. The results of the metallographic analyses of the representative castings are presented in Figures 5, 6, 7, 8.

Taking into account flow direction of the liquid iron through the reaction chamber, a greater participation of nodular graphite precipitates in the microstructure can be observed with test castings located collaterally (cast B). This is a result of additional disorders of liquid iron melt stream through the reaction chamber, which leads to better react master alloy with iron.

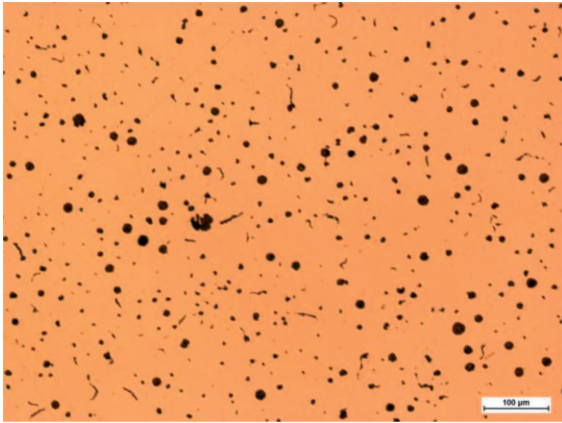

Fig. 5. Microstructure in the test casting: configuration I, reaction chamber W, test cast P

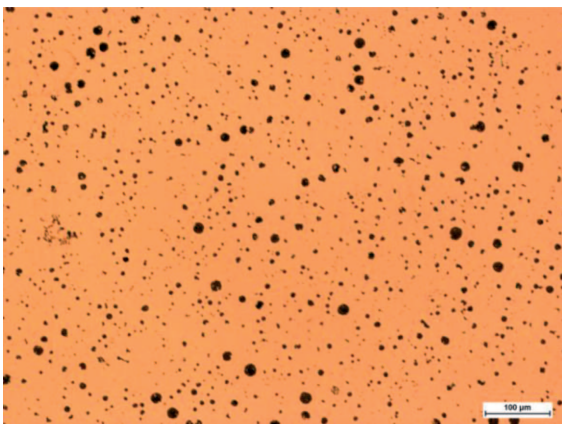

Fig. 6. Microstructure in the test casting: configuration I, reaction chamber W, test cast B

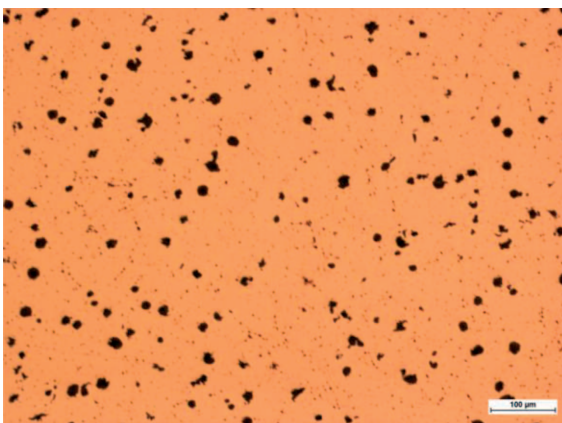

Fig. 7. Microstructure in the test casting: configuration II, reaction chamber N, test cast P

Comparing the microstructure obtained castings due to the height of reaction chamber, a larger participation of nodular graphite precipitates in the microstructure can be observed in the case of test castings, which uses a low reaction chamber (Figs. 7, 8). Small base area of the chamber in relation to its height (reaction chamber W), resulting in a more laminar flow of liquid iron through the reaction chamber than in the case of the chamber, where the ratio of the base area to its height is much larger (reaction chamber N). Stereological analysis has

been made on the microstructures setting graphite shape factor, which is an indicator of the degree of spheroidization of the graphite [7,8]. Reference stereological analysis – participation in a spherical graphite are illustrated in Figures 9, 10, 11.

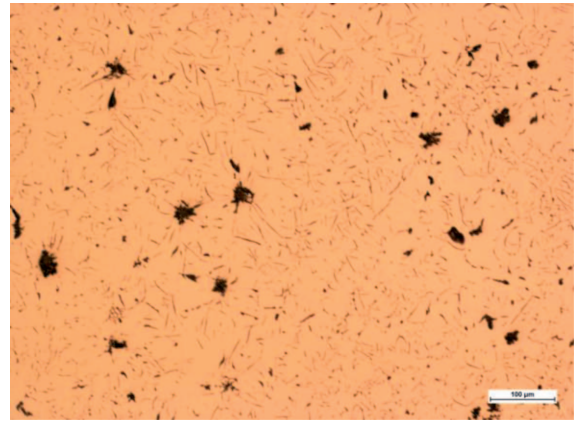

Fig. 8. Microstructure in the test casting: configuration II, reaction chamber W, test cast P

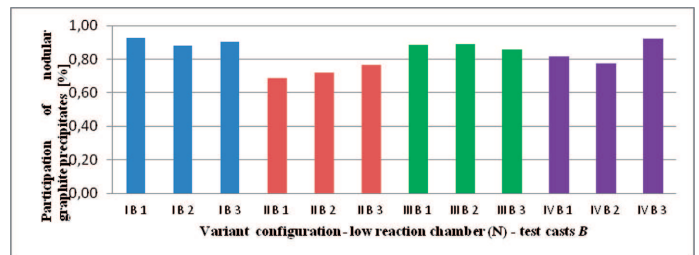

Fig. 9. Participation of nodular graphite precipitates for low reaction chamber castings (N) at different levels (test casts B)

The comparative stereological analyses of test casting samples there were no significant differences of participation of nodular graphite precipitates on various levels in one cast (Fig. 9). In the light of the above for further analysis were used the average values of the participation of nodular graphite precipitates on various levels for each of the castings.

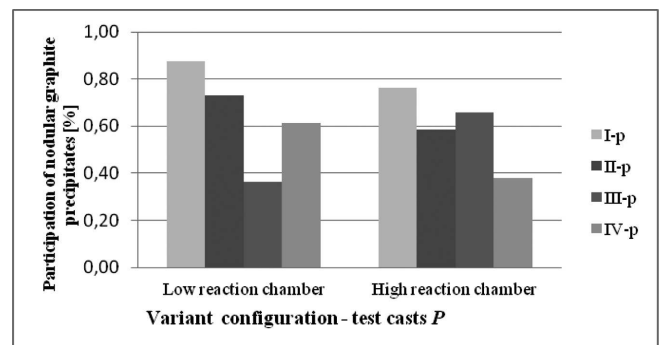

Fig. 10. Participation of nodular graphite precipitates for test castings P

Stereological analyses of participation of nodular graphite precipitates for test castings P (Fig. 10), it can be seen that regardless of the configuration fed, a higher participation of nodular graphite, where was used low reaction chamber which confirms the previously observed dependence of the analysis of microscopic examination. The highest participation of

nodular graphite precipitates was obtained for the cast sample, where: liquid cast iron was fed into the reaction chamber from the bottom and discharged from the top. (average value of nodular graphite precipitates - 80%). Liquid cast iron in this case has a longer contact with the master alloy.

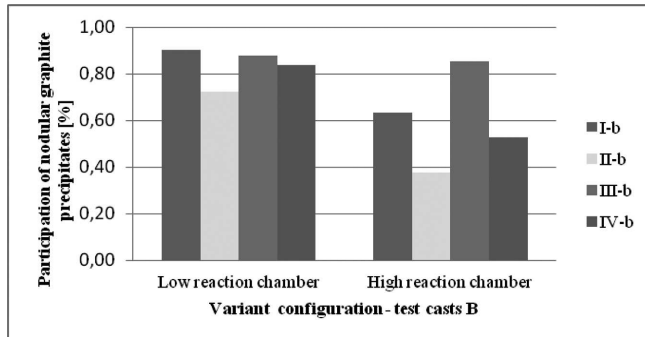

Fig. 11. Participation of nodular graphite precipitates for test castings B

Also, in the case of test casting B the participation of nodular graphite precipitates is higher in the case of a low reaction chamber (Fig. 11).

#### 4. Conclusions

Research has shown strong influence of the gating system configuration, the degree of graphite nodularity. Average value of participation of nodular graphite precipitates for different configurations of the gating system (of 24 samples) is presented in Table 1.

TABLE 1  
Participation of nodular graphite precipitates for different configurations of the gating system

Configuration of the gating system	Average value of nodular graphite, %
Low reaction chamber	0,74
High reaction chamber	0,60
Sprue - bottom	0,70
Sprue - top	0,64
Inlet - bottom	0,60
Inlet - top	0,74
Inlet - lateral	0,72
Inlet - straight	0,62
Test cast – low part	0,64
Test cast – middle part	0,65
Test part –top part	0,71

The data showed that the highest participation of nodular graphite precipitates was obtained for the cast sample, where:

- lower reaction chamber is used – average value of participation of nodular graphite precipitates 0,74%,
- test castings located collaterally – average value of participation of nodular graphite precipitates for test cast B was 0,72%,
- liquid cast iron was fed into the reaction chamber from the bottom and discharged from the top.

In the cast, which uses all of the above: lower reaction chamber, test castings located collaterally and first variant configuration, participation of nodular graphite precipitates was 90%.

Such a high participation of nodular graphite precipitates confirms the assumption that the resignation of the reaction chamber locate the parting plane (such a possibility gives ductile cast iron obtain by lost foam process with use of in mold method), particularly positive impact on the course of spheroidization of graphite in cast iron.

Despite the use of the studies of the reaction chamber of rectangular shape, for which the traditional technologies the lowest nodular graphite precipitates yield was obtained [9], it is possible to obtain a cast iron with a very high participation of nodular graphite precipitates.

#### REFERENCES

- [1] A.J. Clegg, Expanded-polystyrene Moulding – a Status Report, Foundry Trade Journal International, 51-69. June (1986).
- [2] Metals Handbook Volume 15: Casting, Metals Park, Ohio, ASM International, (1988).
- [3] E. Guzik, Procesy uszlachetniania żeliwa. Wybrane zagadnienia, Polska Akademia Nauk, Katowice (2001), pp. 1-128.
- [4] S. Pietrowski, Projekt Celowy Nr ROW-II-363/2008 (2008).
- [5] T. Pacyniak, Teoretyczne i technologiczne podstawy procesu wytwarzania odlewów metodą pełnej formy, Zeszyty Naukowe Nr 985 Politechnika Łódzka (2006).
- [6] T. Pacyniak, R. Kaczorowski, Ductile cast iron obtaining by Inmold method with use of LOST FOAM process, Archives of Foundry Engineering **8**, 3, July-September (2008).
- [7] S. Jura, Z. Jura, The effect of functional stereological parameters of graphite on the mechanical properties of nodular cast iron, Archives of Foundry Engineering, Polish Academy of Sciences – Katowice Branch, No. 1 (2/2), p. 175. (in Polish) (2001).
- [8] P. Just, T. Pacyniak, The Influence of the Shape of the Reaction Chamber on Spheroidization of Cast Iron Produced in the Lost Foam Casting Process with use of the Inmold Method. Archives of Foundry Engineering **12**, 2, 175-178 (2012).
- [9] S. Pietrowski, The influence of the shape of the reaction chamber on cast iron spheroidization in the mould. Archives of Foundry Engineering **10**(3), 164 (2010).

This article was first presented at the VI International Conference "DEVELOPMENT TRENDS IN MECHANIZATION OF FOUNDRY PROCESSES", Inwałd, 5-7.09.2013