

INVESTIGATION OF PLUG ROLLING WITH STUB MANDREL USING THE FINITE ELEMENT METHOD

The study proposed the model of “guide mark” defects formation on the internal surface of pipes, produced on PRM mills of PRP – 140. The research of pipe forming at plug rolling mill with stub mandrel has been carried out; regularities of the dimensionless parameters characterizing the deformation of the gap release, depending on the reduction ratio, were determined. The model of “guide mark” defect formation on the internal surface of the pipe has been proposed. This allows for lesser wall thickness variation of rough tubes. It has been shown that, when using dioctahedral pass designs in comparison with hexagonal pass designs the proportion of displaced volume along the pipe axis is greater but the value is lower; thereby, the risk of “guide mark” defect forming is reduced.

Keywords: plug rolling mill, plugging with stub mandrel, forming, guide mark defect, finite element simulation FEM

1. Introduction

On pipe-rolling plants (PRP) – 140 of Public Joint-Stock Company «Sinarsky Pipe Works» pipes are rolled from carbon and alloy steels and they are: drill pipes, casing pipes, pipes for power plant of engineering industry and others of diameters 73÷168 mm with wall thickness 5÷23 mm [1]. An outstanding feature of pipes production on PRM – 140 is limitation on deformation of pipes at plug rolling mills (PRM), which are the part of the pipe-rolling plants and are spaced some distance apart. Elongation ratio on PRM-1 is within the limits of 1.16÷1.50, and on PRM-2 – 1.07÷1.15 [2,3]. Application of higher elongation ratio leads to “guide mark” defects appearance (Fig. 1) on internal surface of the pipe. So far there is no unanimous view about the reasons of this defect appearance and no objective and accurate analysis of this problem has been made. Preventive recommendations of “guide mark” defect appearance are ambiguous and controversial. The study of the process of lengthwise rolling of tubes is presented in [4,5].

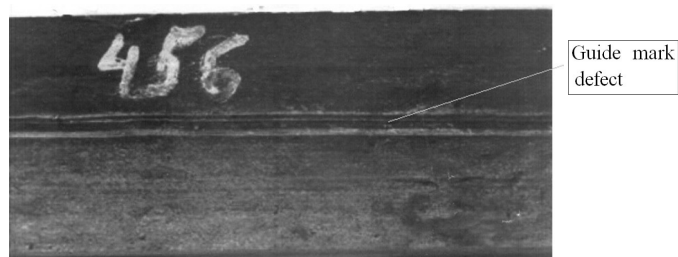

Fig. 1. Guide mark defect on the internal surface of the pipe

This study proposes the model of “guide marks” formation and provides the research of pipe forming at plug rolling mill (Fig. 2).

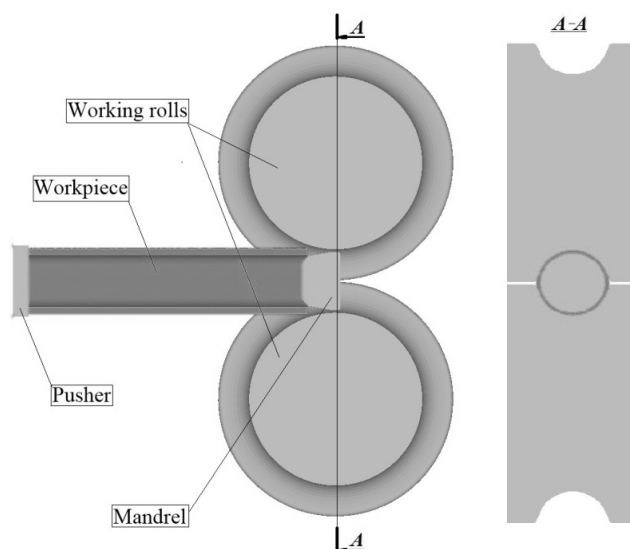

Fig. 2. Scheme of the plug rolling mill

2. A study of “guide mark” defect formation on the internal surface of the pipe during plug rolling

A “guide mark” defect appears as follows, Fig. 3 [6]:
1) when rolling is performed on PRM-1, there is intensive metal flowing into the tapers, it results in a thicker pipe walls

* URAL FEDERAL UNIVERSITY NAMED AFTER THE FIRST PRESIDENT OF RUSSIA B.N. YELTSIN, INSTITUTE OF MATERIAL SCIENCE AND METALLURGY, YEKATERINBURG, RUSSIA
** METAL FORMING INSTITUTE, 14 JANA PAWLA II AV., 61-139 POZNAN, POLAND

Corresponding author: dyja.henryk@wip.pcz.pl

in the groove tapers than in the upper part of the groove (S_1 is a wall thickness of the pipe in the groove taper and S_2 is a wall thickness of the pipe in the upper part of the groove) [7-9]. This point causes the stripes on the pipe surface are forming, Fig. 3a; 2) after pipe turning to 90° , the pipe is rolled in PRM-2, and the stripes get into the tapers, Fig. 3b. When the groove is filled stripes are forming on the mandrel, and the jamming occurs, Fig. 3c; 3) when rolling is performed in a three-roll blooming mill and then in a stretch-reducing or sizing mill, jamming on the internal surface of the pipe turns into a “guide mark” defect. Thus the increase of S_1/S_2 ratio leads to “guide mark” defect formation on the internal surface of the pipe.

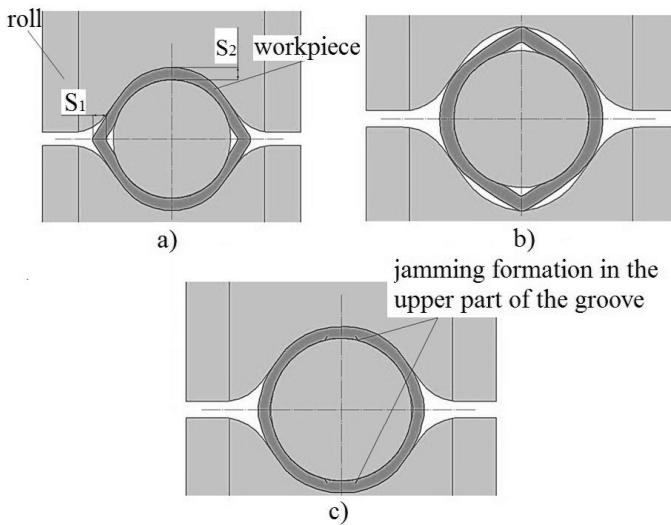

Fig. 3. Scheme of the “guide mark” defect formation on the internal surface of the pipe, a) stripe formation in the groove tapers when rolling on plug rolling mill 1, b) pipe having been turned is clamped by the upper part of the groove of plug rolling mill 2, c) jamming at groove filling

3. A study of forming in the plug rolling of rough tubes

The study of pipe forming was carried out using «DEFORM – 3D» software solution. Following the recommendations of the programmers and taking into account a practical data about pipes rolling on the PRM mill [10,11] the initial conditions included

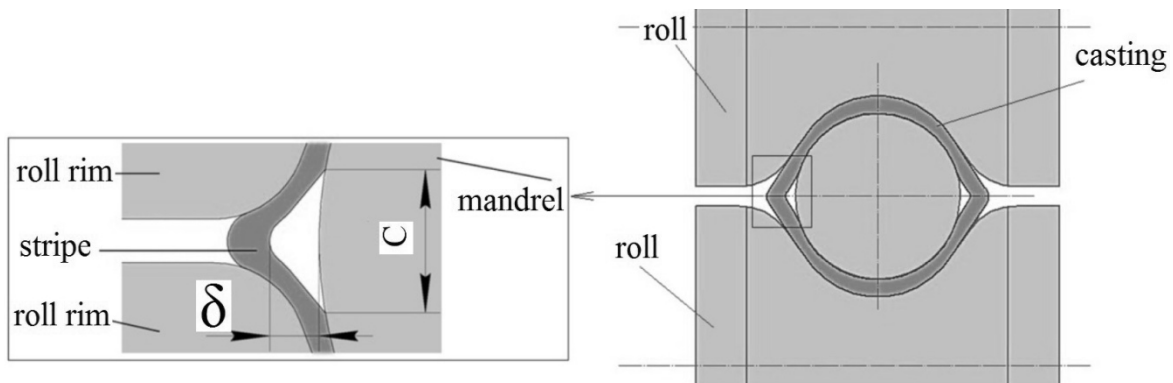

Fig. 5. Scheme for the determination of δ and C ratios

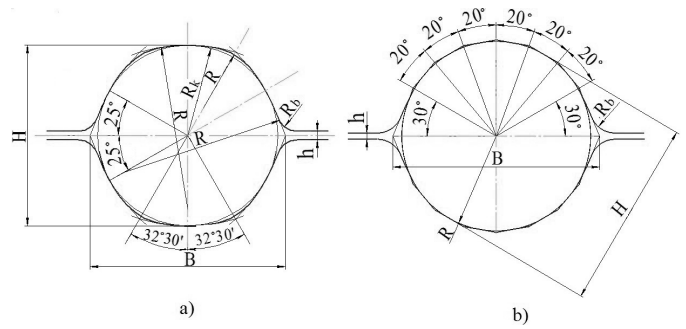

Fig. 4. Hexagonal (a) and dioctahedral (b) working roll pass

data about temperature of the pipe $T = 1200^\circ\text{C}$, temperature of roll and mandrel $T = 150^\circ\text{C}$, air temperature $T = 20^\circ\text{C}$. Friction was set on the base of Siebel $\tau_{fs} = \psi\tau_s$. Friction ratio on the roll was equal to $\psi = 0.7$, and on the mandrel – $\psi = 0.2$. Rotational speed of rolls on PRM-1 was equal to 125 rpm. Diameter of the roll body on PRM was $D_b = 590$ mm. Diameter of stock material which was manufactured on the piercing mill was equal to $D_0 = 166$ mm in all the experiments, and the shell wall thickness was different $S_0 = 10, 11, 12, 13$ and 14 mm. Mandrel diameter was $D_{man1} = 146$ mm. Diameter of tubes after rolling on PRM-1 was $D_0 = 160$ mm in all the experiments. Therefore, elongation ratio λ at the first pass was: 1.46; 1.6; 1.73; 1.86; 1.99.

The study of metal forming was carried out for two options of working rolls pass design: hexagonal and dioctahedral (Fig. 4). When simulating the rolling process is running operating roll pass designs on PRM-140 were applied.

The study of metal forming consisted of determination of the principles of elongation ratio influence to dimensionless ratios, which characterize pipe deformation in the groove taper: S_1/S_2 ; δ/S_2 ; C/S_2 . Where: S_1 – pipe wall thickness in the groove taper; S_2 – pipe wall thickness in the upper part of the groove; δ – clearance between mandrel and the internal surface of the pipe; C – spreading of a free mandrel surface (Fig. 5).

The results of calculations for metal forming in a groove taper during pipe rolling in the first pass (PRM-1) using hexagonal and dioctahedral pass designs are listed in Table 1. Figures 6,7 and 8, based on data from Table 1, present the dependence of dimensionless ratios characterizing the pipe deformation in the groove taper from elongation ratio λ .

TABLE 1

The results of calculations of dimensionless ratios characterizing metal forming at rolling on PRM-1

Elongation ratio λ	Hexagonal pass designs ratios			Dioctahedral pass designs ratios		
	$\frac{S_1}{S_2}$	$\frac{\delta}{S_2}$	$\frac{C}{S_2}$	$\frac{S_1}{S_2}$	$\frac{\delta}{S_2}$	$\frac{C}{S_2}$
1.46	1.31	0.13	3.36	1.24	0.11	2.44
1.60	1.39	0.11	2.44	1.3	0.08	1.83
1.73	1.48	0.09	2.03	1.33	0.06	1.24
1.86	1.57	0.08	1.83	1.42	0.05	0.95
1.99	1.73	0.05	0.47	1.62	0.02	0.12

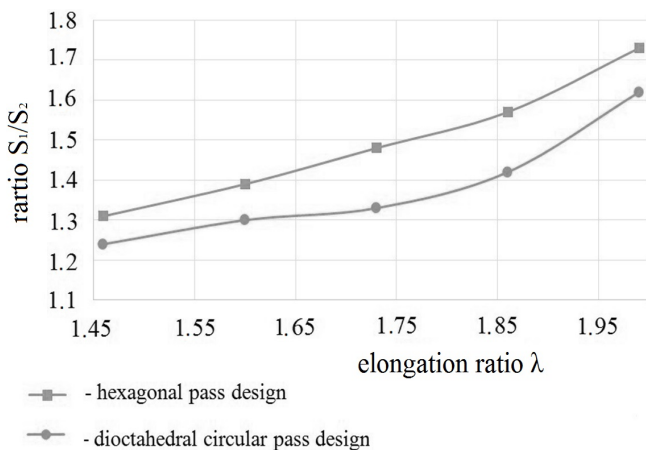

Fig. 6. Dependence of S_1/S_2 ratio from elongation ratio λ

Fig. 6 shows that the growth of the elongation ratio λ , leads to the increase of the wall thickness in the groove taper, which is evidenced by growing S_1/S_2 ratio. Thus an increase of elongation ratio λ leads to an increase of wall thickness variation of rough tubes. It should be noted that increase in wall thickness in the groove taper develops less intensively when rolling with dioctahedral rolls pass design than rolling with hexagonal rolls pass design.

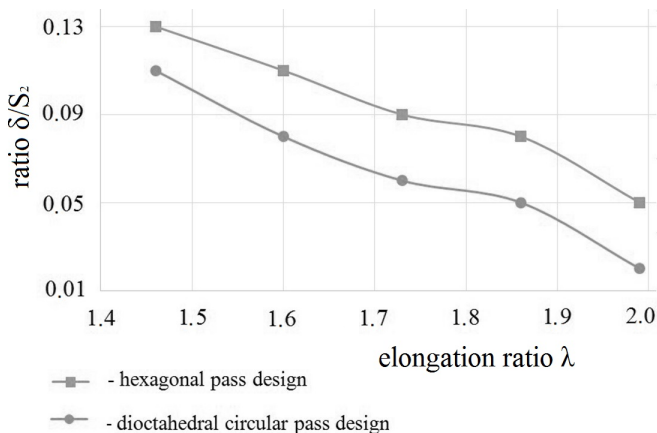

Fig. 7. Dependence of δ/S_2 ratio from elongation ratio λ

Figs. 7 and 8 also demonstrate that with the growth of the elongation ratio λ , δ/S_2 and C/S_2 ratios decrease, which indicates

the decrease in the gap between the pipe and the mandrel. It is also important that during rolling with dioctahedral rolls pass design the values of δ/S_2 and C/S_2 ratios are smaller than during the rolling with hexagonal rolls pass design. From this it follows that when using dioctahedral pass design rolls, the pipe is more tightly adhere to the mandrel.

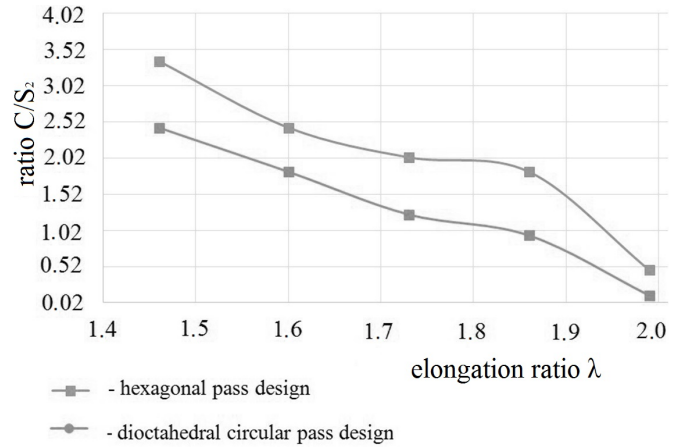

Fig. 8. Dependence of C/S_2 ratio from elongation ratio λ

Thus it is determined that the bigger is S_1/S_2 ratio the possibility of clamps and “guide mark” defects formation grows. Therefore during plug rolling with hexagonal rolls pass design, “guide mark” defect formation on the internal surface of the pipe is more likely to occur than during rolling with dioctahedral pass design. Also, the use of dioctahedral rolls pass design allows to decrease a wall thickness variation of rough tubes.

4. Conclusions

The study proposed the model of “guide mark” defects formation on the internal surface of the pipes produced on PRM mills of PRP – 140. The study of pipe forming was carried out using «DEFORM – 3D» software solution. Regularities of dimensionless ratios S_1/S_2 ; δ/S_2 ; C/S_2 were determined depending on the elongation ratio on the first stand of elongator. It was determined that the bigger the S_1/S_2 ratio is, the bigger is the possibility of clamps and “guide mark” defects formation. When δ/S_2 and C/S_2 ratios take smaller values, the pipe more tightly adhere to the mandrel. This allows for lesser wall thickness variation of rough tubes. It has been shown that using dioctahedral pass designs in comparison with hexagonal pass designs the proportion of displaced volume on the pipe axis is greater but the value is lower; thereby, the risk of “guide mark” defect forming is reduced.

Aknowlegement

Supported by Act 211 Government of the Russian Federation, agreement No 02.A03.21.0006

REFERENCES

- [1] V.V. Kharitonov, A.A. Bogatov, V.Yu. Vakhrushev, Equipment for Pipe Rolling, Extrusion and Drawing, 2008 USTU-UPI, Ekaterinburg.
- [2] I.N. Potapov, A.P. Kolikov, V.M. Druyan, Theory of Pipe Making, 1991 Metallurgiya, Moskva.
- [3] V.N. Danchenko, A.P. Kolikov, B.A. Romantsev, Pipe-Making Technology, 2002 Intermetinzhiniring, Moskva.
- [4] H. Dyja, K. Sobczak, A. Kawalek, Metalurgija **52** (1), 35-38 (2013).
- [5] A. Ghiotti, S. Fanini, P.F. Bruschi, Manufacturing Technology **58**, 255-258 (2009).
- [6] A.A. Bogatov, D.A. Pavlov, S.V. Lipnyagov, V.N. Suvorov, E.A. Pavlova, Steel in Translation **44** (12), 912-915 (2014).
- [7] A. Kawalek, H. Dyja, J. Markowski, Metallurgy **42** (3), 207-211 (2003).
- [8] T. Katsumura, K. Ishikawa, A. Matsumoto, S. Sasaki, Y. Kato, J. Yanagimoto, Key Engineering Materials 622-623, 899-904 (2014).
- [9] A.A. Bogatov, E.A. Pavlova, D.A. Pavlov, Proceedings of the 3rd International Conference COMAT 2014.
- [10] A.P. Karamyshev, I.I. Nekrasov, A.I. Pugin, A manual for the program Deform-3D Software Package, 2010 UrFU Publ., Ekaterinburg.
- [11] P.M. Dixit, U.S. Dixit, Modeling of Metal Forming and Machining Processes. Manchester Materials Science Centre, Manchester, (2008).