

W. ŁOGIN<sup>#</sup>, R.E. ŚLIWA<sup>\*\*</sup>, R. OSTROWSKI<sup>\*\*</sup>, J. ANDRES<sup>\*</sup>

## THE INFLUENCE OF TOOL GEOMETRY FOR REFILL FRICTION STIR SPOT WELDING (RFSSW) ON WELD PROPERTIES DURING JOINING THIN SHEETS OF ALUMINUM ALLOYS

The paper presents the results of research on the modification of the face geometry of the refill friction stir spot welding tool sleeve for welding thin aluminum sheets with an Alclad and an oxide anode coating. The analysis of the impact of such modification on the process perform (tool motion parameters, temperature) and microstructure as well as mechanical strength of the lap joints were analyzed. The tests were carried out using aluminum alloy 2024-T3 sheets with thickness 1.27 mm. For comparative purposes, joints were also made using plates without an Alclad and without anodized coating with using unmodified tool and modified tools with developed 3 variants of face geometry. The samples with the joint were subjected to metallographic and strength tests. It has been shown that the use of modified geometry has a decisive influence on the performance of the process and the effect of softening and mixing of materials in the zone of point connection.

*Keywords:* RFSSW, joint strength, material softening, RFSSW tools

### 1. Introduction

Despite the increasing use of composite materials in aircraft constructions, aluminum alloys still play a significant role. It is associated with a very good knowledge of their mechanical properties and behavior during the operation of the aircraft, easy manufacture, relatively good durability and corrosion resistance in industrial and marine environments. The aluminum alloys most commonly used in aviation belong to the 2xxx and 7xxx series. They are characterized by very good strength properties with low density at the same time.

For the tests the aluminum alloy 2024 in the T3 state was used, which is characterized by good formability and increased yield strength, which is particularly important when forming aircraft parts. The basic alloying addition in this group of materials is copper, which plays a key role in the strengthening process, but also has a negative effect on corrosion resistance. Pitting corrosion is particularly dangerous in aerial constructions. In order to protect the metal against its operation, an Alclad is used in the form of a thin layer made of 1xxx series aluminum alloy [1,2]. The research shows, that the Alclad can reduce the mechanical properties of the material, however, in aggressive corrosive conditions, it significantly improves fatigue life [3]. In addition, aircraft parts are protected against corrosion by the use of different types additional layers prior to the application of paint layers, e.g. by anodizing (formation of an aluminum oxide layer in current processes), chromate coatings created by a sol-gel process or by alodining.

Characteristic feature of aluminum alloys in both the 2xxx and the 7xxx series is their poor weldability. In aircraft structures, these materials are most often joined by riveting. This process is time-consuming and in the case of manual riveting is burdened with a very high risk of human error. Other disadvantages of the riveting process are the increase in the mass of the structure, the possibility of occurrence of damage caused by the foreign body (Foreign Object Damage – FOD) and high noise in the case of impact riveting. Another method of joining structures made of these aluminum alloys is resistance welding. It is characterized by high repeatability of welds, ensures a smooth surface at the joining point, and the connection obtained has a relatively good strength. Among the main disadvantages of the resistance welding process of aluminum alloys one can mention the necessity of using a high welding current (high energy consuming process) and the provision of oxide-free surfaces. In addition, poorly selected process parameters, electrode wear or surface contamination result in defects in the welds.

An alternative method of joining for the above mentioned techniques is refill friction stir spot welding (RFSSW). This process takes place below the melting point of the combined materials, i.e. without the use of a liquid phase. Welding is carried out with the use of a dedicated drive head and a special tool consisting of three elements: an outer sleeve (a clamp), an inner sleeve and a pin. During the process the outer sleeve together with the head housing and anvil are fixed, while the inner sleeve and the pin rotate at the same speed and performing the coupled linear movements along the tool axis. A detailed description of

\* POLSKIE ZAKŁADY LOTNICZE SP. Z O.O., WOJSKA POLSKIEGO 3, 39-300 MIELEC, POLAND

\*\* RZESZÓW UNIVERSITY OF TECHNOLOGY, ALEJA POWSTAŃCÓW WARSZAWY 12, 35-959 RZESZÓW, POLAND

# Corresponding author: joginek@poczta.fm

the process and the mechanism of creating the weld has been described, among others, in the works [4-8].

An important issue during joining thin sheets is the temperature of the process, which has a direct impact on the deformation of the structure after the welding. From this point of view, the RFSSW process parameters – the tool rotational speed, welding time and penetration depth should be selected in the way which allow to obtain a weld with satisfactory properties but with generating the lowest possible temperature of the process at the same time. As research shows, properly selected parameters allow to obtain repetitive welds that are free from structural defects. The situation is slightly different in the case of joining Alclad sheets. An important issue in this case is also the appropriate fragmentation and mixing of additional material in the native material. Larger groups of Alclad material in the connection area, or its excessive upward displacement, become a structural notch and affect the load capacity of the joint [9,10].

The fabrication of the correct joint of metal sheets with the friction stir welding technology depends mainly on the nature of the flow of the materials to be joined, i.e. softening and their proper mixing in the joint zone. This phenomenon is mainly influenced by process parameters related to the tool – rotational speed, linear motion speed and work surface geometry as well as the properties of the joined materials. In the case of Friction Stir Welding (FSW), there are number of variations of tools geometry that allow to obtain welds with the required characteristics, specific for a given type of metallic material. In the case of RFSSW welding, the process of weld formation and process kinematics significantly limits the possibilities of modifying the geometry of the tool, and at the same time the flow of material in the softening zone is complex. In addition, the process is even more complicated when Alclad sheets are joined, introducing additional material, i.e. coating material, into the joining area. Due to the complex process kinematics [11] and the design of the RFSSW tool, modifications that can be applied are limited. In the literature, one can find attempts to analyze the modification of tool geometry based on numerical simulations and mechanical tests. As a rule, modifications of the tools are to cause more intensive mixing and transport of material during the creation of the weld. The results of the work show that these changes affect the welding process and allow high-quality connections to be obtained in a much wider range of parameters than in the case of the standard tool [7,8].

This paper presents the results of testing the effect of modifying the face surface of the RFSSW inner sleeve on weld properties. In the development of geometry, literature information regarding the use of different geometries for FSW tools, technological capabilities of the developed variants and the possible impact on the process were taken into account.

## 2. Material and methodology of research

The basic material used for the research was a sheet of aluminum alloy 2024-T3 (according to AMS-QQ-A-250/5)

with a thickness of 1.27 mm (0.05”), with Alclad both side. According to the standard, the thickness of the Alclad is about 4% of the material thickness per side. The welding process was performed on 356 × 120 mm sheets, which had been subjected to anodizing in sulfuric acid in order to obtain an oxide layer of 5-8 μm in thickness. In addition, a sheet without anti-corrosion coatings was also used for comparison. The sheets were connected overlapping by a width of 30 mm. 10 welds were made on one set, from which individual samples for tensile strength and microscopic tests were cut out (Fig. 1). The welds were made using the Harms & Wende RPS 100 welding machine.



Fig. 1. View of the fabricated joints – sample with 10 welds with pointed single sample (210 × 30 mm)

During welding with tools of new geometry, the temperature was recorded on the outer sleeve and the anvil using the Honeywell Multitrend recorder and N-type thermocouple (Fig. 2). Tensile strength tests were carried out on the MTS Landmark machine according to PN-EN ISO 6892-1, failure load [kN] was

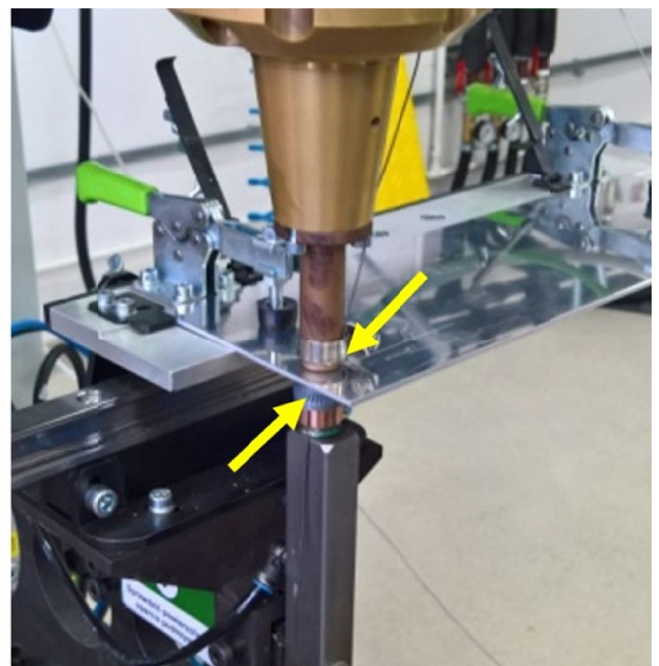

Fig. 2. Temperature measurement – places of fixing the thermocouples on the tool and the anvil

recorded for each sample tested. Samples for metallographic tests were ground, polished and etched at ambient temperature in Keller's reagent (5 ml HF, 15 ml HCl, 25 ml HNO<sub>3</sub>, 955 ml H<sub>2</sub>O). The prepared specimens were subjected to microstructural observations on the Zeiss digital optical microscope.

For the tests the tool with the manufacturer's designation WZ-12 was used, whose outer diameter of the inner sleeve is 9 mm, while the diameter of the pin is 5.2 mm (Fig. 3).

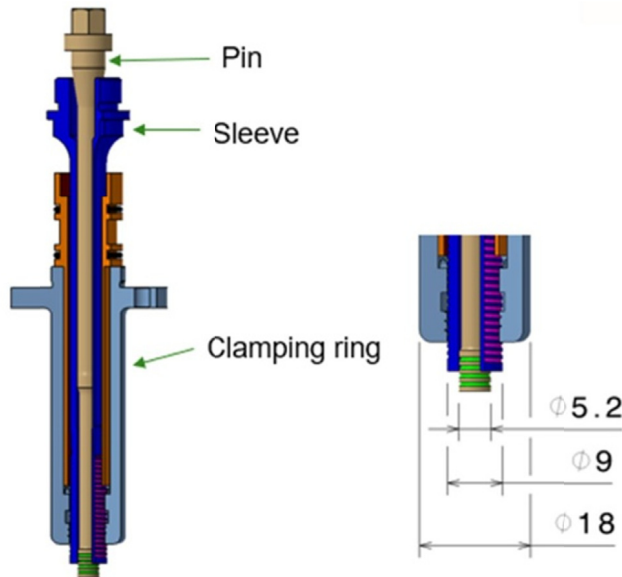

Fig. 3. WZ-12 tool dimensions

For the needs of the research, three geometries were developed, which were made using milling technology on the face of the inner sleeve, Fig. 4.

The incisions were designed and made as circular grooves so that they could be made using a ball cutter in one pass. The geometry G1 has been proposed as a single spiral coming out tangentially from the outer surface, which in two turns is also tangentially inserted into a full groove around the inner hole. Geometry G2 and G3 are radially incised 5 spiral sections that have been arranged symmetrically on the face. The difference between geometry G2 and G3 results from the direction of cutting. In the case of geometry G2 it is consistent with the direction of movement of the tool during operation, while geometry number G3 has the opposite direction.

The research was carried out using two sets of process parameters. In the case of the standard tool (commercial, with flat surface of the inner sleeve), the R1 parameters were used: tool speed  $S = 1000$  rpm, dwell depth  $h = 1.3$  mm, welding time  $t = 4$  s (2 s plunging and 2 s retreating). These parameters were chosen based on previous test results as the best for this material configuration (own research with not published data). In the case of tools with a modified surface, the parameters R2 were used: rotational speed of the tool  $S = 1500$  rpm, dwell depth  $h = 1.3$  mm, welding time  $t = 4$  s. Correction of rotational speed was introduced after visual observation of the first welds, increasing them to 1500 rpm due to the occurring of craters on the perimeter of the weld, the remaining parameters remained unchanged.

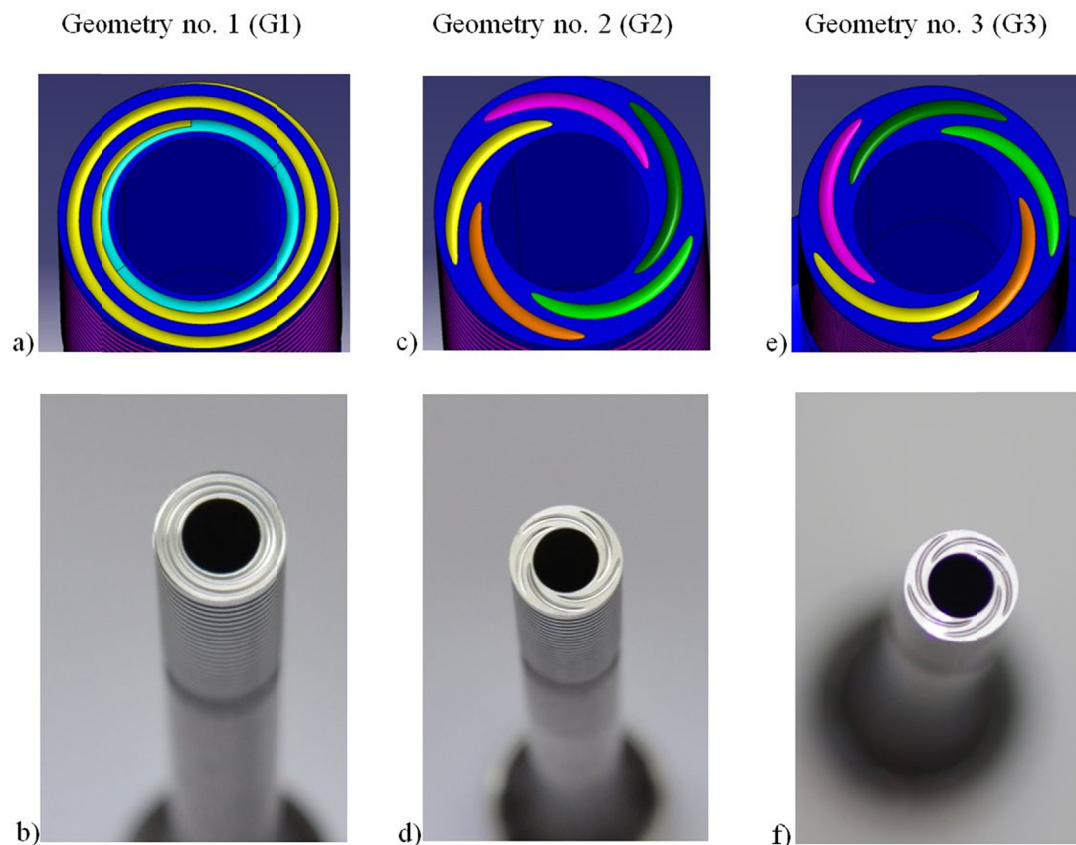

Fig. 4. Developed geometries: a) model view of geometry G1, b) photo of G1 rows made on the inner sleeve, c) model view of geometry G2, d) photo of G2 rows made on the inner sleeve, e) model view of geometry G1, f) photo of G1 rows made on the inner sleeve

### 3. Analysis of test results

Conducted comparative tests of static strength and microstructure analysis of joints made on bare sheet, Alclad sheet, and with Alclad and anodized sheet, allowed to determine the main objective of work, i.e. to determine the effect of corrosion protection on the properties of joints. All welds were made with a standard tool with R1 parameters. Fig. 5 presents the results of tests of tensile strength of the joints made.

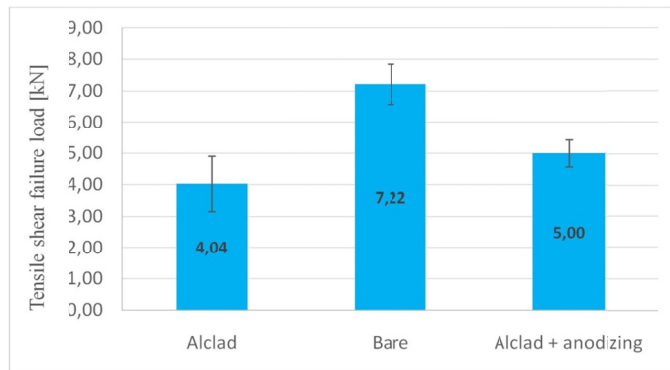

Fig. 5. Tensile shear failure load of joints made with the standard tool on sheets: Alclad, bare and Alclad + anodizing

The highest tensile shear failure load was achieved for welds made on the bare material. The lowest failure load have joints made on plates with Alclad. In the case of anodized sheets, the load capacity of the joint is higher by 1 kN compared to Alclad sheets but at the same time more than 2 kN lower than those

made on bare material. Analyzing the structure of the joints, one can observe a different degree of material mixing of the joined sheets within the weld depending on the applied coating (Fig. 6).

In the case of bare sheets, the obtained weld is characterized by very good quality, there is mixing with the material of the bottom sheet, there are no visible defects. Welds made on Alclad sheet have significant clusters of the coating material in the central part and a strip of unmixed material over the entire width. In this case there is also no penetration into the material of the lower sheet, there are voids and defects in the material from the face side. The weld made on anodized sheets does not have any defects in the form of voids, there is a mix with the material of the bottom sheet, clusters are visible on the circumference of the bottom of the weld, which has been moved even into the thermo-mechanical distortion zone.

The research has shown that the presence of the Alclad has a significant impact on the load capacity of the joint. In the case of aviation structures, due to the need to provide adequate corrosion protection, its presence is essential. Therefore, it is important to look for a way to properly mix the Alclad material in the RFSSW weld, so as to ensure the least possible adverse effect on the bearing capacity of the joint. At the same time, one should bear in mind the effect of this material clusters on the formation of structural notches that will also affect the quality of the connection.

Subsequently research on the impact of modifying the front surface of the inner sleeve on the properties of welds and the degree of Alclad distribution was carried out. The tests were conducted on anodized sheets, and the welding process was carried out with R2 parameters.

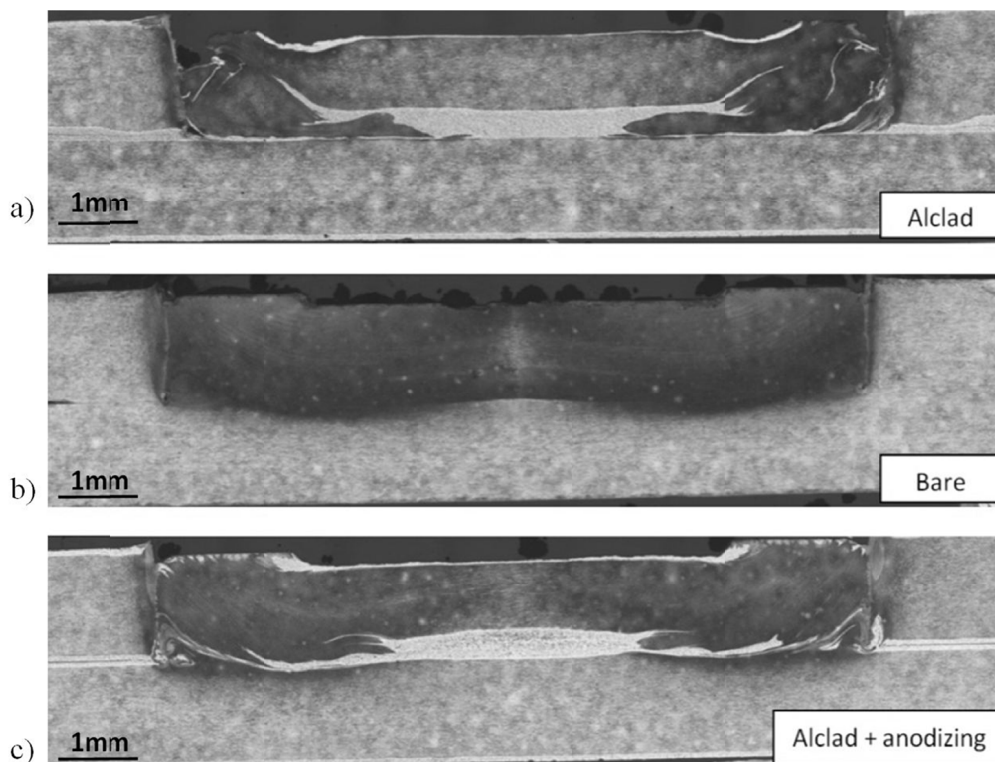

Fig. 6. Microstructure of welds made with a standard tool with parameters R1, a) Alclad sheets, b) bare material, c) Alclad + anodizing sheets

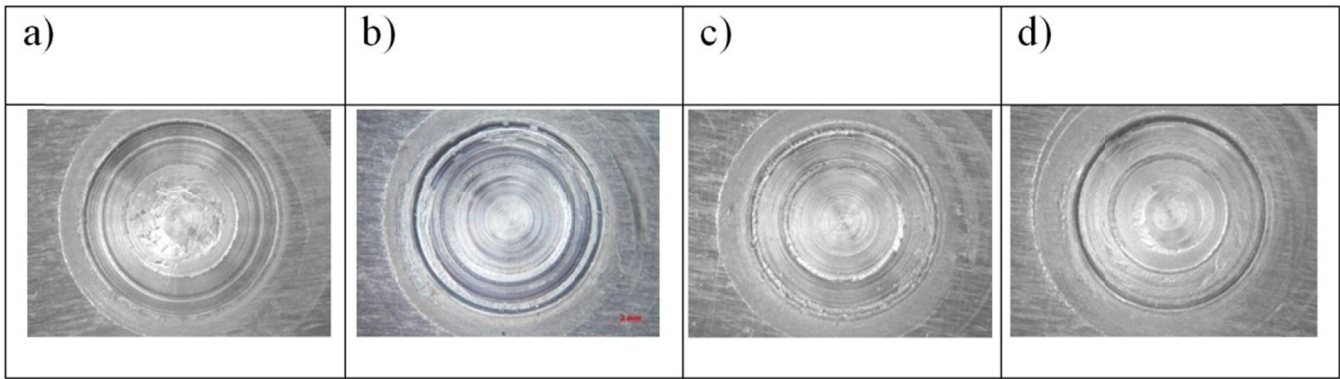

Fig. 7. The face of welds made with the standard tool a) G0 and tools with modified geometry b) G1, c) G2, d) G3

One of the criteria of a correctly made RFSSW joint is the visual evaluation of the weld face immediately after its execution, especially when choosing process parameters and setting the tool. Attention is paid to material losses around the perimeter, craters, excessive flash and surface smoothness. The tests carried out allowed, among other things, to determine the impact of modifying the face of the sleeve in the form of notches on the weld face. In the case of the analyzed geometries, the visual assessment of welds did not show significant differences with respect to those obtained using the standard tool (G0), Fig. 7.

Analyzing the results of strength tests, one can notice a significant influence of particular geometry variants on the load capacity of the joints made with this tools (Fig. 8).

Treating the basic geometry G0 as a reference, comparable results were obtained using the G2 geometry. In the case of G1 geometry, the results were about 15% higher, while with the G3 tool the load capacity of joints was about 20% lower.

Analyzing the microstructure of welds made with the tested tools, one can notice differences in their structure (Fig. 9). For the G0 geometry, the Alclad layer is focused on the sheet metal interface over the entire width of the weld. On the circumference of the weld there are relatively thick Alclad material upwards extractions and there is no mixing with the material of the lower sheet. For G1 geometry there is clearly better mixing of Alclad layer in relation to the G0 geometry, in particular on the circumference of the weld. Mixing with the material of the lower sheet is visible, and the Alclad extractions are more diffused. The weld has no visible defects in the working area of the inner sleeve. With G2 geometry, the mixing with the bottom sheet material is similar to that of G1 geometry. The Alclad strips are not visible on the perimeter of the weld and there are no extrusions. Noticeable are lighter bands in the area of the inner sleeve operation, which may suggest the deposition of the material of the plating in these places. A visible disadvantage of this weld is a significant loss of material at the perimeter of the upper surface. The weld made with the G3 geometry tool has noticeable disturbances of material placement on the perimeter of the weld, which could have a negative effect on the strength. It is particularly unfavorable for the plating to be turned upwards in the area beyond the weld. Most of the material of the Alclad was concentrated in the central part of the weld. The mixing with the lower sheet

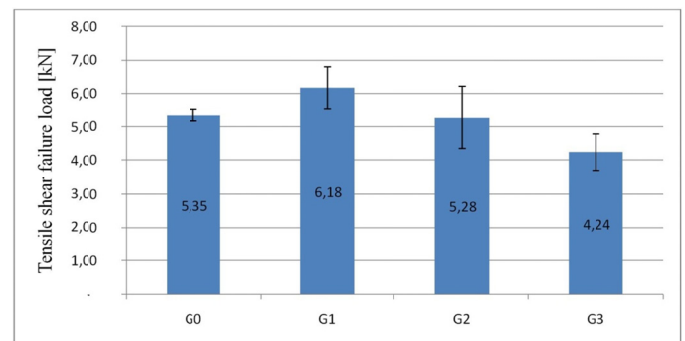

Fig. 8. Tensile shear failure load of joints made with the standard tool G0 and with modified tools G1-G3

occurs at the outside diameter of the sleeve and not as with the geometry G1 and G2 on the inside.

Temperatures recorded during fabricating the joints with using G0-G3 tools are shown in Fig. 10. In each case, before the start of fabrication the test welds, the tool was heated by performing several (3-5) welds on auxiliary sample material. This allow to get preheated tool before starting the proper process. The high temperature amplitudes for the anvil are the result of the water cooling system used in its construction, which, as can be seen, is very efficient. In the case of the clamp, the cooling water circuit is carried out only in the upper part of the tool, so that the recorded amplitudes of temperature changes between subsequent welds are significantly smaller.

Analyzing the temperature graphs it can be seen that the temperature on the anvil in all cases oscillates around 200°C and the maximum is practically the same when making welds. The exception here is the G2 tool for which the maximum for subsequent welds increases. The situation looks quite different with the temperature recorded on the clamp. For the G0 and G2 geometries, it can be seen increasing with subsequent welds. In the case of standard geometry, the temperature has even exceeded 300°C. For G3 geometry, temperature stabilization can be observed after 5 welds, while for G1 from the second weld. At the same time, the temperatures were much lower compared to the G0 and G2 tools. The lowest values were recorded for the G3 tool, where the temperature only slightly exceeded 250°C.

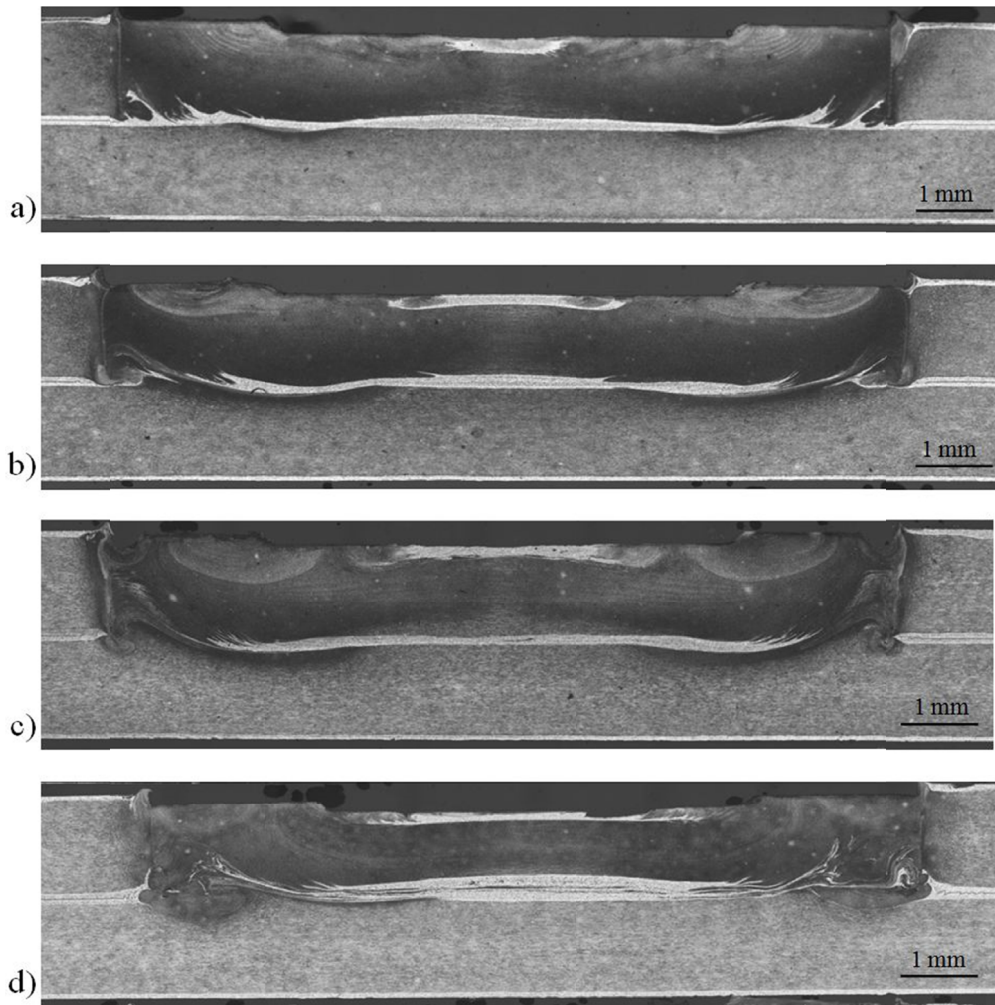

Fig. 9. Microstructure of the welds: a) tool G0, b) tool G1, c) tool G2, d) tool G3

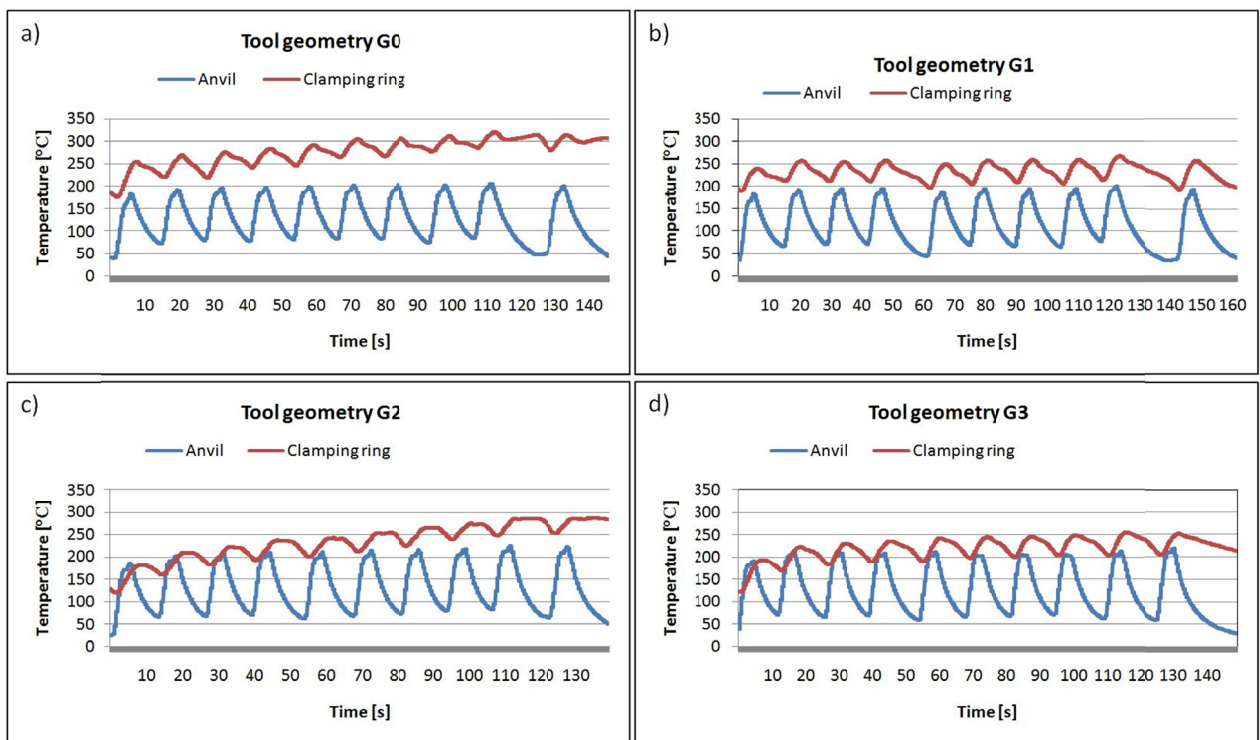

Fig. 10. Temperatures recorded during fabrication sample with 10 welds: a) tool G0, b) tool G1, c) tool G2, d) tool G3

#### 4. Conclusions

The modification of the front face of the inner sleeve of the RFSSW tool affects the properties of the weld. The presence of the Alclad causes a reduction in the load capacity of the connection made with the standard tool by more than 3 kN in the case of only Alclad sheets and over 2 kN in addition anodized sheets. Research has shown that by using the right geometry, higher mechanical strength of the weld can be obtained compared to the standard tool. In the case of the tested geometries and material configuration, the strength increase was over 15% (0.83 kN). Tools with modified geometry allow better mixing of the material of the Alclad in the volume of the weld, have an impact on the process temperature and its stability. Visual inspection showed no deterioration in the quality of the weld faces. No adverse effect of the examined geometry variants on the formation of defects on the surface of elements originating from cuts on the surface of the tool were observed. In the welds made with modified tools, there were no defects in the form of voids. Among the examined geometries, the most favorable was an incision in the form of a spiral and a continuous groove around the hole of the sleeve (geometry G1). In order to define the most favorable geometry for the application of RFSSW technology when connecting anodized Alclad sheets made of aluminum alloy 2024, further tests are necessary, also taking into account the optimization of process parameters.

#### Acknowledgements

Financial support of The National Centre for Research and Development, European Union, PZL Mielec / a Sikorsky Company, in the framework of European Regional Development Fund Project "Advanced techniques

for the fabrication of airframe structures using innovative friction stir welding (FSW) technology", no. INNOLOT/I/4/NCBR/2013 is gratefully acknowledged.

#### REFERENCES

- [1] L. Kwiatkowski, *Inz. Powierzchni* **4**, 24-33 (2009).
- [2] G. Mrówka-Nowotnik, J. Sieniawski, K. Raga, M. Wierzbńska, *Mat. Eng.* **33**, 601-604 (2012).
- [3] S.G. Pantelakis, A.N. Chamos, A.T. Kermanidis, *Theor Appl Fract Mec* **57**, 36-42 (2012).
- [4] H.G. Yang, H.J. Yang, X. Hu, Simulation on the plunge stage in refill friction stir spot welding of Aluminum Alloys, 4th International Conference on Mechatronics, Materials, Chemistry and Computer Engineering, Atlantis Press, DOI: 10.2991/icmmce-15.2015.105 (2015).
- [5] Y.Q. Zhao et al., *Mater. Des.* **62**, 40-46 (2014).
- [6] Z. Xu et al., *J. Mater. Sci. Technol.* **34**, 878-885 (2018).
- [7] Z. Shen, Y. Ding, O. Gopkalo, B. Diak, A.P. Gerlich, *J. Mater. Process. Technol.* **252**, 751-759 (2018).
- [8] J. Shude, W. Yue, L. Zhengwei, Y. Yume I, C. Peng, *Trans. Indian. Inst. Met.* **70**, 1417-1430 (2017).
- [9] J.Y. Cao, M. Wang, L. Kong, L.J. Guo, *J. Mater. Process. Tech.* **230**, 254-262 (2016).
- [10] Y.Q. Zhao, H.J. Liu, S.X. Chen, Z. Lin, J.C. Hou, *Mater. Des.* **62**, 40-46 (2014).
- [11] J.Y. Cao, M. Wang, L. Kong, H.X. Zhao, P. Chai, *Mater. Charact.* **128**, 54-62, (2017).
- [12] S.M. Manladan et al., *Int. J. Adv. Manuf. Technol.* **90**, 605-634 (2017).
- [13] M. Tier, J.F. dos Santos et al., A study about the mechanical properties of Alclad AA 2024 connections processed by friction spot welding 1, Research Gate (2009).