

T. MERDER*, J. JOWSA**, A. BOGUSŁAWSKI**

THE ANALYSIS OF THE CONDITIONS OF STEEL FLOW IN THE TUNDISH PERFORMED BY A NUMERICAL METHOD

ANALIZA WARUNKÓW PRZEPŁYWU STALI W KADZI POŚREDNIEJ PRZEPROWADZONA METODĄ NUMERYCZNĄ

An important continuous steel casting (CSC) device is the tundish, in which a stabilized steel flow has a crucial effect on the quality and efficiency conditions of the CSC process. Steel at an appropriate temperature is poured from the main ladle to the tundish at a preset rate (speed) and then flows over this vessel and fills it up to a specified height. Next, the steel flows out through the openings in the tundish bottom to CSC mould.

The aim of the study was to diagnose the current state of flow in a multi-opening tundish used in the domestic metallurgical industry for casting medium-size products. In this connection, actions were undertaken aimed at the determination of the detailed characteristics of operation of the facility. The investigation involved the numerical simulation of mass, momentum and energy transfer processes. In the considered case, the mathematical model for the flow of liquid steel includes differential equations of the continuity of flow and the conservation of momentum and energy, and equations describing the turbulence of liquid steel flow in the tundish. For modelling turbulence, the $k-\epsilon$ semi-empirical two-equation model with standard set of empirical model constants proposed by Jones and Launder was used. This model is commonly used in the analysis of engineering problems.

The facility under consideration is a six-strand trough-type tundish of a liquid metal capacity of 22 Mg, designed for casting ingot. The tundish is symmetrical relative to the lateral plane passing through the gate; for this reason, the calculations were performed for half of the facility. In numerical calculations, two tundishes — one without a dam, and the other with two dams positioned between the gate and two middle strand openings — were taken into consideration.

The calculations were carried out using FLUENT, a commercial computer program. The calculation (3D) area was discretized with a non-structural grid thickened at the tundish gate and nozzles. In the presented calculations, adaptation of the calculation grid was made using the dimensionless parameter y^* . The calculations were performed either in stationary and non-stationary conditions.

* KATEDRA EKSTRAKCJI I RECYRKULACJI, POLITECHNIKA CZĘSTOCHOWSKA, 42-200 CZĘSTOCHOWA, AL. ARMII KRAJOWEJ 19

** INSTYTUT MASZYN CIEPLNYCH, POLITECHNIKA CZĘSTOCHOWSKA, 42-200 CZĘSTOCHOWA, AL. ARMII KRAJOWEJ 21

As a result of calculations, distributions of the fields of velocities, temperature and turbulence energy were obtained. The obtained results have provided a significant knowledge of steel casting conditions. To verify whether the tundish condition is suitable for non-metallic inclusion removal and agitation processes during the sequential casting of different steel grades, or not, residence time distribution (RTD) curves were plotted. On their basis, individual flow shares for the investigated tundish were estimated.

Ważnym urządzeniem procesu ciągłego odlewania stali (COS) jest kadź pośrednia, w której ustabilizowany przepływ ma bardzo duży wpływ na warunki jakościowe i wydajnościowe tego procesu. Stal o odpowiedniej temperaturze wylewana jest z kadzi głównej do kadzi pośredniej o zadanej wydajności (prędkości), a następnie rozpyta się w tym naczyniu i wypełnia je do określonej wysokości. Po czym wylewa się otworami znajdującymi się w dnie kadzi do krystalizatorów urządzenia COS.

Celem badań było zdiagnozowanie aktualnego stanu przepływu w wielootworowej kadzi pośredniej, stosowanej w hutnictwie krajowym do odlewania wyrobów średnich. W związku z tym podjęto działania zmierzające do określenia szczegółowych charakterystyk pracy obiektu. Badania polegały na numerycznej symulacji procesów transportu masy, pędu i energii.

W rozważanym przypadku model matematyczny dla przepływu ciekłej stali zawiera równania różniczkowe ciągłości przepływu, zachowania pędu i energii oraz równania opisujące turbulencję ruchu ciekłej stali w kadzi. Dla modelowania turbulencji, wykorzystano semiempiryczny, dwurównaniowy model $k-\varepsilon$ zaproponowany przez Jones'a i Lauder'a. Model ten jest powszechnie stosowany w analizie zagadnień inżynierskich.

Rozpatrywany obiekt to sześciowylwewowa korytowa kadź pośrednia o pojemności 22 Mg ciekłej stali, do odlewania wlewków ciągłych. Kadź jest symetryczna względem płaszczyzny poprzecznej przechodzącej przez wlew, z tego względu obliczenia wykonano dla połowy obiektu. W obliczeniach numerycznych rozpatrywano dwie kadzie — bez przegrody i z dwiema przegrodami umieszczonymi między wlewem, a środkowymi otworami wylwowymi.

Obliczenia przeprowadzono za pomocą komercyjnego programu komputerowego FLU-ENT. Obszar obliczeniowy (3D) dyskretyzowano za pomocą siatki niestrukturalnej, zagęszczonej przy wlewie i wylwach kadzi. W prezentowanych obliczeniach stosowano adaptację siatki obliczeniowej z uwzględnieniem bezwymiarowego parametru y^+ . Obliczenia realizowano w warunkach ustalonych i nieustalonych.

W wyniku obliczeń otrzymano rozkłady pól prędkości, temperatury i energii turbulencji. Uzyskane wyniki dają istotną wiedzę o warunkach odlewania stali. Opracowano krzywe rozkładu stężeń i czasu przebywania RTD (*Residence Time Distribution*) dla sprawdzenia, czy stan kadzi jest odpowiedni dla usuwania wtrąceń niemetalicznych oraz mieszania w trakcie sekwencyjnego odlewania różnych gatunków stali. Na ich podstawie oszacowano udziały poszczególnych rodzajów przepływów.

Nomenclature

- C Dimensionless concentration; -
 c Concentration of the tracer in the outlet stream; $kg\ m^{-3}$
 $c_{1\varepsilon}c_{2\varepsilon}$ Model constants $k-\varepsilon$; -
 c_p Specific heat; $Jkg^{-1}K^{-1}$
 $C\varepsilon$ Empirical coefficients; -

$C\mu$	Constant; $C\mu = 0.09$
D_{eff}	Effective diffusion coefficient; m^2s^{-1}
D_m	Molecular diffusion coefficient; m^2s^{-1}
D_t	Turbulent diffusion coefficient; m^2s^{-1}
g_i	Gravitational acceleration; ms^{-2}
k	Turbulence kinetic energy; m^2s^{-2}
k_t	Turbulent thermal conductivity; $Wm^{-1}K^{-1}$
k_{eff}	Effective thermal conductivity $k_{eff} = \lambda + k_t$; $Wm^{-1}K^{-1}$
P	Pressure; Pa
Pr_t	Turbulent Prandtl number; $Pr_t = 0,85$
T	Temperature; K
t	Time; s
\bar{t}	Theoretical (mean) residence time; s
t_{min}	Minimum breakthrough time; s
t_{peak}	Time at which the peak concentration is reached; s
t_{av}	Mean residence time; s
Q	Amount of tracer added to the tundish; kg
u	Velocity; ms^{-1}
$u_{i,j}$	Velocity components; ms^{-1}
u_T	Velocity of boundary flow friction; ms^{-1}
V	Volume of liquid in the tundish; m^3
\dot{V}_a	Volumetric rate of flow through the active region of the tundish; m^3s^{-1}
V_d	Dead volume friction; -
V_{dp}	Plug flow volume friction; -
$V_{s.c.f.}$	Short-circuited flow volume friction; -
V_m	Well mixed flow volume friction; -
\dot{V}_1, \dot{V}_2	Volumetric flow rate; m^3s^{-1}
\dot{V}	Total volumetric flow rate; m^3s^{-1}
X_m	Tracer mass fraction; -
y	Distance of the closest point from the rigid wall; m

Greek symbols

C	Dissipation rate of the turbulent kinetic energy; m^2s^{-3}
μ	Dynamic coefficient of viscosity; $kgm^{-1}s^{-1}$
μ_{eff}	Effective coefficient of viscosity; $kgm^{-1}s^{-1}$
μ_t	Dynamic coefficient of turbulent viscosity; $kgm^{-1}s^{-1}$
λ	Thermal conductivity; $Wm^{-1}K^{-1}$
θ	Dimensionless time; -
θ_{av}	Mean dimensionless time -
θ_{min}	Minimal dimensionless time; -
θ_{peak}	Peak dimensionless time; -
ρ	Specific density; kgm^{-3}

$\sigma_k, \sigma_\varepsilon$ Empirical coefficient corresponding to turbulent Prandtl number; -
 ν Kinematic viscosity of liquid; m^2s^{-1}

1. Introduction

An important continuous steel casting (CSC) device is the tundish, in which a stabilized steel flow has a crucial effect on the quality and efficiency conditions of the CSC process. Steel at an appropriate temperature is poured from the main ladle to the tundish at a preset rate (speed) and then flows over this vessel and fills it up to a specified height. Next, the steel flows out through the openings in the tundish bottom to CSC mould. At this time, the steel gives up part of its thermal energy to the environment through the convection and radiation processes. The motion of metal in the tundish is determined by tundish geometry and pouring conditions. The purpose of the tundish is to assure the constant conditions of supplying liquid metal to all mould strands by maintaining the constant liquid steel level, and to maintain the proper temperature of cast steel as a result of using a cover and providing a capability of heating up the tundish. The device performs the role of the final element of the steel production cycle, enabling the improvement of liquid steel quality, and in particular reducing the amount of non-metallic inclusions. By shaping casting conditions, we can enhance the processes of separation and flotation of non-metallic inclusions. For this purpose, different geometries of tundish interior (such as dams, baffles, weirs, etc.) are used. They cause a local increase in the intensity of liquid steel flow turbulence, which promotes the collisions of inclusions and favours coalescence, thus facilitating inclusions flowing out from the bulk metal to the surface and being absorbed by the slag. The shape and arrangement of dams and baffles has also an effect on the thermal conditions prevailing in the tundish. Their optimal construction assures a more uniform distribution of the temperature of cast steel. Depending on tundish interior geometry, there are zones of diverse flow intensities within the tundish, which can be classified into two areas: an active area and a stagnant area often referred to as the dead region, which is shown in Figure 1.

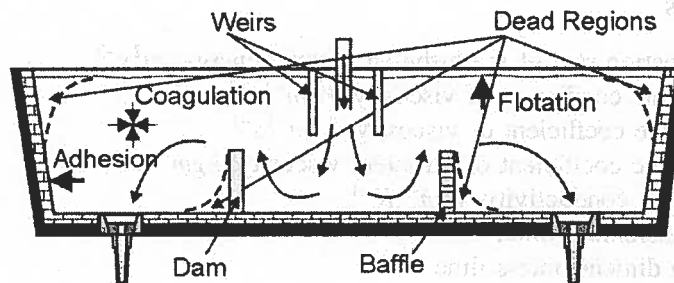

Fig. 1. Schematic of the tundish with representation of melt flow having dead volume and removes inclusion mechanism

The aim of the study is to diagnose the current condition of the multi-opening tundish used in the domestic metallurgical industry for casting medium-size products. In this connections, actions were undertaken, aimed at the determination of the detailed characteristics of operation of the facility. The tundish under investigation is a trough-type device with six strands, having no active internal constructional elements.

As the detailed studies of metal motion (hydrodynamics) on a real object are in principle unlikely, the solution of this problem was only possible with the use of the modelling technique. A decision was made to choose numerical modelling based on a developed mathematical model. This method, owing to the considerable computing capacities of contemporary computers, provides capabilities of solving very complex problems and enables the simulation of an examined phenomenon after setting boundary conditions similar to real ones. This approach allows the evaluation of velocity fields, temperature distribution and the concentrations of bath constituents in the conditions of an arbitrary tundish geometry. Obtained characteristics make it possible to choose a tundish geometry optimal for the required conditions of operation of the facility. Presently, *CFD (Computational Fluid Dynamics)* programs relying on the methods of the computational mechanics of fluids are used for such calculations.

Considerable contribution to the modeling of steel flow in the tundish has been made by Professors Julian Szekely [1] and Roderick I. L. Guthrie [2, 3]. The numerical calculations were performed using the commercial software PHOENICS and computational codes (METFLO 3D) developed by individual authors. Noteworthy is the published article on „The Physical and Mathematical Modeling of Tundish Operations” [4] which describes, in a concise form, the basic aspects of investigating and solving the problems of the optimization of construction of the continuous steel casting tundish. However, examples given therein do not include multi-strand tundishes.

2. The mathematical model

The mathematical model designed for the simulation of liquid steel flow in the tundish will include differential equations of the continuity of flow and conservation of momentum and energy, and an equation describing the structure of turbulence of liquid steel movement in the tundish. The equations are represented in the Cartesian coordinate system and index notation.

The mass conservation equation (equation of continuity) has the following form:

$$\frac{\partial \rho}{\partial t} + \frac{\partial}{\partial x_j} (\rho u_j) = 0. \quad (1)$$

The momentum conservation equation is defined as follows:

$$\frac{\partial(\rho u_i)}{\partial t} + \frac{\partial(\rho u_i u_j)}{\partial x_{ij}} = -\frac{\partial P}{\partial x_i} + \frac{\partial}{\partial x_j} \left[\mu_{eff} \left(\frac{\partial u_i}{\partial x_j} + \frac{\partial u_j}{\partial x_i} \right) \right] + \rho g_i. \quad (2)$$

Despite that the constant steel density is assumed in the calculations showed below the system of conservation equation is presented in conservative form used in Fluent to derive discretization equations by control volume approach.

The effective coefficient of viscosity is expressed by the formula below

$$\mu_{eff} = \mu + \mu_t, \quad (3)$$

where the dynamic coefficient of turbulent viscosity is defined by the formula

$$\mu_t = C_\mu \rho \frac{k^2}{\varepsilon}. \quad (4)$$

For modelling turbulence, the $k-\varepsilon$ semi-empirical two-equation model with standard set of empirical model constants proposed by Jones and Lauder [5] was used, which is commonly utilized in the analysis of engineering problems. In many cases of turbulent flows, this model yields results close to experimental results, with limited computational outlays. The two equations of the $k-\varepsilon$ model have the following form:

for the kinetic energy of turbulence:

$$\frac{\partial(\rho k)}{\partial t} = \frac{\partial}{\partial x_i} \left[\left(\mu + \frac{\mu_t}{\sigma_k} \right) \frac{\partial k}{\partial x_i} \right] + G - \rho \varepsilon \quad (5)$$

for the rate of turbulence energy dissipation

$$\frac{\partial(\rho \varepsilon)}{\partial t} = \frac{\partial}{\partial x_i} \left[\left(\mu + \frac{\mu_t}{\sigma_\varepsilon} \right) \frac{\partial \varepsilon}{\partial x_i} \right] + \frac{(c_{1\varepsilon} \varepsilon G - c_{2\varepsilon} \rho \varepsilon^2)}{k} \quad (6)$$

where the production term of turbulence energy is equal to

$$G = \mu_t \frac{\partial u_j}{\partial x_i} \left[\left(\frac{\partial u_i}{\partial x_j} + \frac{\partial u_j}{\partial x_i} \right) \right]. \quad (7)$$

Constants used in the $k-\varepsilon$ model are given in Table 1.

TABLE 1
Constants used in the $k-\varepsilon$ model

$C_{1\varepsilon}$	$c_{2\varepsilon}$	c_μ	σ_k	σ_ε
1.44	1.92	0.09	1.0	1.3

To determine the distribution of temperature fields within the tundish, it is necessary to use the energy conservation equation in the form as below

$$\frac{\partial(\rho T)}{\partial t} + \frac{\partial(\rho u_j T)}{\partial x_j} = \frac{\partial}{\partial x_j} \left(\frac{k_{eff}}{c_p} \frac{\partial T}{\partial x_j} \right). \quad (8)$$

The effective thermal conductivity is described by the following formula

$$k_{eff} = \lambda + k_t. \quad (9)$$

The turbulent thermal conductivity is defined by the formula below

$$k_t = \frac{c_p \mu_t}{Pr_t}. \quad (10)$$

To calculate the concentration of the additive (tracer) in the tundish, it is necessary to complete the above system of equations by adding a differential equation of the following form

$$\frac{\partial(\rho c)}{\partial t} + \frac{\partial(\rho u_j c)}{\partial x_j} = \frac{\partial}{\partial x_j} \left(\rho D_{eff} \frac{\partial c}{\partial x_j} \right), \quad (11)$$

where the effective diffusion coefficient (D_{eff}) is the sum of the molecular diffusion coefficient and the turbulent diffusion coefficient

$$D_{eff} = D_m + D_t, \quad (12)$$

The turbulent diffusion coefficient is determined from the following relationship (assuming that the turbulent Schmidt number is equal to unity).

$$\frac{\rho D_{eff}}{\mu_{eff}} \cong 1. \quad (13)$$

The presented system of equations was solved numerically by the control volumes method in the three-dimensional (3D) domain.

3. Model description

The facility under study is an example of the trough-type tundish for casting ingots intended for small cross-section rolled products, such as reinforcing bars, flat bars, wire rod, etc.

The object taken for investigation is a typical trough-type multi-strand tundish, as used in the domestic metallurgical industry. According to the opinion of metallurgists, it should be subjected to modification involving changes to the internal space geometry by installing additional flow regulators. At the same time, due to financial outlays, the changes should be limited as far as possible. The tundish is symmetrical relative to the transverse plane and has six strands. Figure 2 shows half of the device with most important dimensions indicated. Its nominal capacity is 22 Mg. Steel is poured into the tundish through a ceramic screen positioned in the device's plane of symmetry.

The detailed constructional parameters and technological operation conditions of the model tundish are as follows: L1 — 2785 mm, L2 — 2700 mm, L3 — 300 mm, L4 — 500 mm, L5, L6 — 1000 mm, W1 — 1040 mm, W2 — 850 mm, W3 — 640

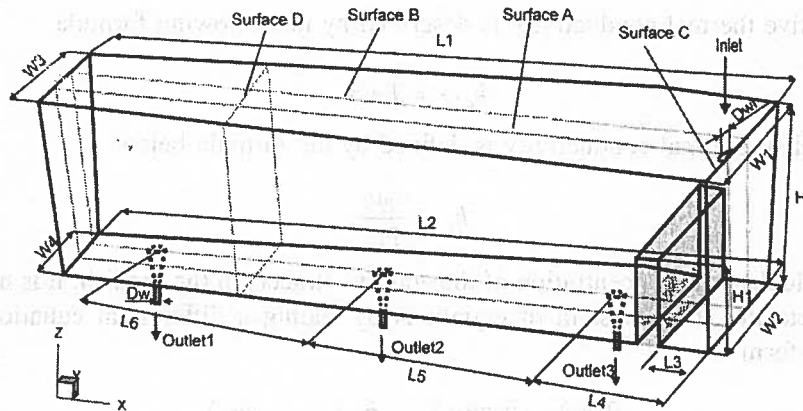

Fig. 2. Schematic presentation of geometric dimensions for the tundish (symmetric half of the object) employed in the numerical calculations

mm, W_4 — 450 mm, steel bath height H — 740 mm, the height of the proposed dam H_1 — 370 mm, gate diameter D_{wl} — 66 mm, nozzle diameter D_w — 14 mm, and the number of strands — 6. The dam in the tundish, shown in Fig. 2, actually does not exist and is a proposal for a modification to the interior of the device, and it will also be the subject of simulation computations. The following properties of liquid steel were taken: specific density — 7010 kg/m^3 , specific heat — $821 \text{ J/kg}\cdot\text{K}$, thermal conductivity — $30,5 \text{ W/m}\cdot\text{K}$, and viscosity — $0,007 \text{ kg/m}\cdot\text{s}$.

4. Conditions of numerical computations

For the presented system of differential equations describing the model of flow in the tundish, proper boundary conditions should be set. The system under consideration is spatial and symmetrical, since the tundish geometry is symmetrical relative to the plane passing through the gate axis. The result is the zeroing of the first derivatives in relation to the direction normal to the plane of symmetry. The flow in the boundary layer was modelled using the so called “wall function”. This method enables a considerable reduction in computational outlays, as it uses an analytical solution for the description of the field of velocities in the boundary region, which permits a much smaller number of nodal points to be used in this region. At the system boundary corresponding to the gate, a medium (steel) flow-in velocity of -0.9 m/s was assumed, which corresponds to a mass flux of 1.33 Mg/min at a turbulence intensity of 5%. The velocity of flux flow-out of the tundish results from the mass balance. The upper surface of the device, i.e. the contact of the liquid steel with the air, was assumed to be a free surface, which was assumed further to be a flat surface.

The thermal conditions of tundish operation determine the following boundary conditions:

- 1) the free steel surface gives up the heat to the environment by radiation and natural convection, while resulting heat losses are defined by the unit heat flux and, according to literature, amount to 15000 W/m^2 [6];
- 2) for the tundish walls and bottom, heat losses to the environment are assumed to be in the form of a heat flux equal to 2600 W/m^2 [7].

For the evaluation of the distribution of tracer concentration in the steel during the casting process, two types of boundary conditions were set at the gate:

- 1) at the moment $t = 0$, a one-off tracer addition is $X_m = \frac{Q}{V \rho_{\text{steel}}} = 0,0019$ of mass fraction; and
- 2) the tracer concentration is uniform and normalized ($C=1$) in the whole period of measurement.

An important element in the numerical computation is the distance of the first computation grid node from the wall. In the program, this problem is described by the dimensionless parameter y^+ which, according to the instruction manual of the Fluent software [8], should be contained in the range from 30 to 60 for the model (*Standard Wall Functions*). This parameter is calculated from the following formula:

$$y^+ \equiv \frac{\rho u_{\tau} y}{\mu}. \quad (14)$$

In the computations discussed, computation grid adaptation was used while considering the dimensionless parameter y^+ . This procedure was repeated many times so as to stay within the limits of y^+ correctness, i.e. (30÷60). Target design of the computational grid includes 250000 control volumes, condensed in the vicinity of the gate and at the tundish strands.

In computations, the segregated solver and the following numerical procedures were used: Discretization Pressure — Body Force Weighted, [8], Discretization Pressure-Velocity Coupling — SIMPLEC [9], Discretization Momentum — upwinding of order II [8].

5. Computation results

Computations were carried out for both stationary and non-stationary (transient) conditions. Non-stationary calculations were only performed to determine the curves of steel mixing characteristics and residence time diagrams (RTD). The solution of the model with a satisfactory convergence was obtained after performing approx. 60 thousand iterations. To illustrate the fields of steel velocities within the tundish, they were represented in four control planes indicated in Fig. 2. Plane A crosses the tundish lengthwise, passing through the gate, while plane B passes through the tundish strands. Plane C is the device's plane of symmetry, whereas plane D is parallel to it and situated at a distance of 1890 mm from it. The distribution of velocity vectors in the original tundish (without a dam) is illustrated in Figures 3÷6. In Figure 3 (in the gate plane), two distinct vortices of oppositely oriented rotation are observed. Such their arrangement

should have a favourable effect on nonmetallic inclusions flowing out to the slag. In a further distance from the steel flow-in (Fig. 4), a horizontal steel stream flow starts to predominate in the system of vectors, which is less favourable for flowing out of nonmetallic inclusions. The distribution of velocities over the tundish length is illustrated in the diagrams (Figs. 5 and 6).

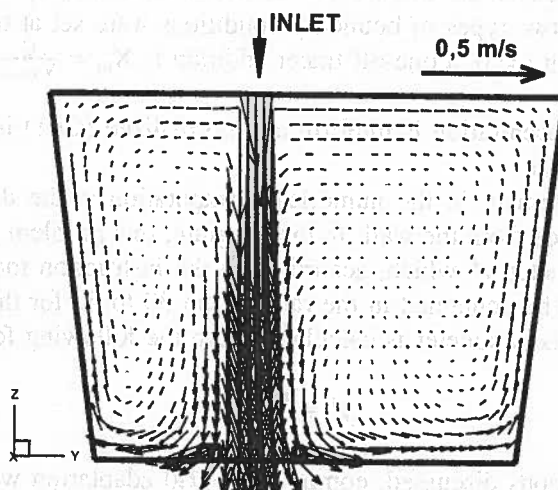

Fig. 3. Velocity (m/s) fields of steel (profiles) in vertical plane (C) of the tundish

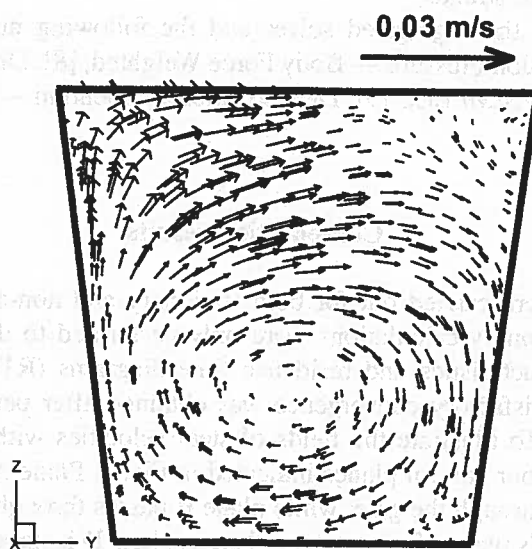

Fig. 4. Velocity (m/s) fields of steel (profiles) in vertical plane (D) of the tundish

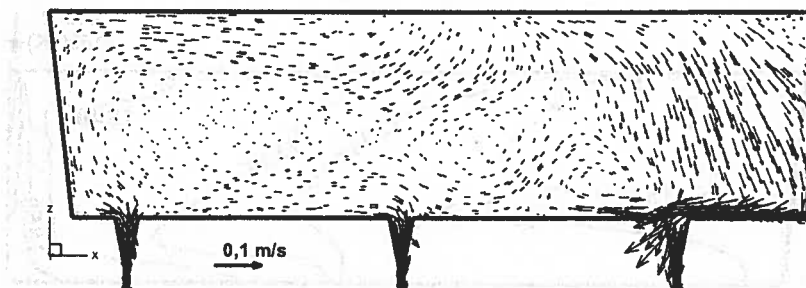

Fig. 5. Velocity (m/s) fields of steel (profiles) in vertical plane (B) of the tundish

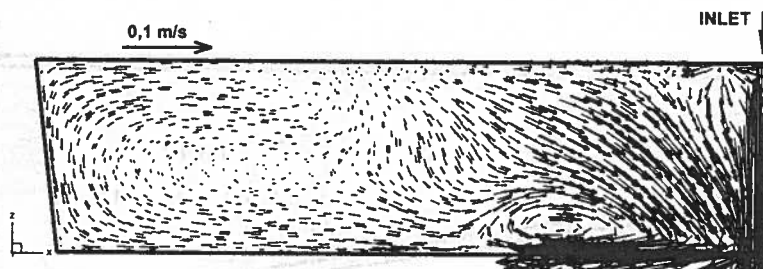

Fig. 6. Velocity (m/s) fields of steel (profiles) in vertical plane (A) of the tundish

The computed fields of steel temperatures prevailing in the tundish interior have equalized distributions, which is depicted in Figs 7÷9, and the temperature differences at the strands do not exceed 9 K. The values of mean temperatures at particular nozzles are given in Table 2.

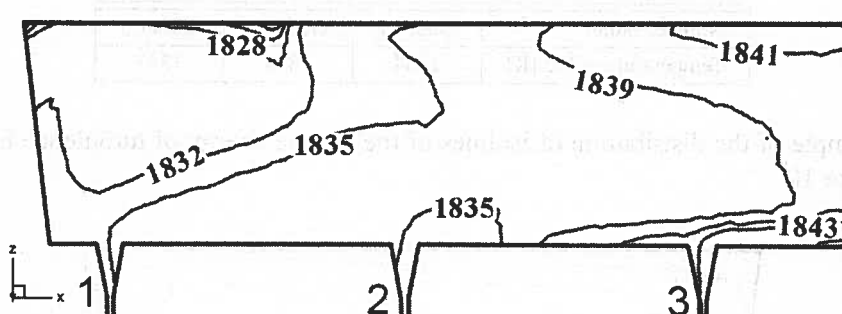

Fig. 7. Isotherms (K) in steel in the vertical plane B

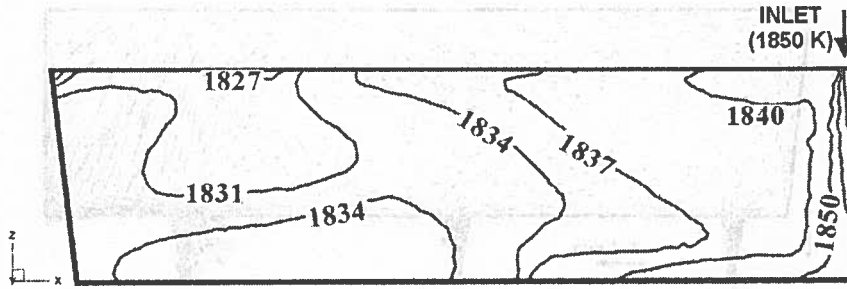

Fig. 8. Isothermus (K) in steel in the vertical plane A

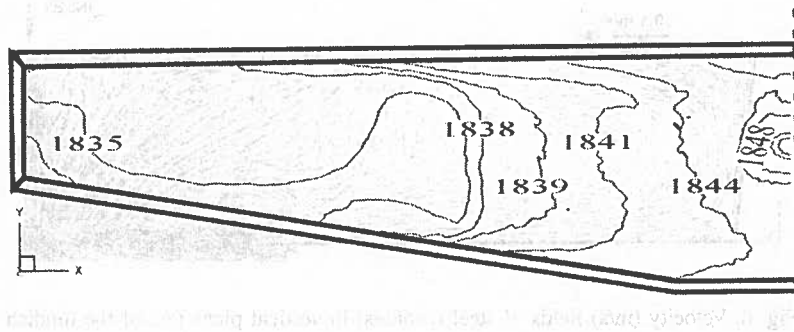

Fig. 9. Isotherms (K) in steel near floor plane (at 5% total height)

Average temperature on outlet of tundish

TABLE 2

Number outlet	Outlet 1	Outlet 2	Outlet 3
Temperature value [K]	1834	1834	1842

An example of the distribution of isolines of the kinetic energy of turbulence is shown in Figure 10.

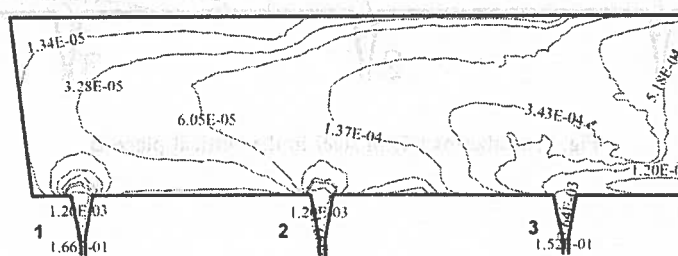

Fig. 10. Isolines of turbulent kinetic energy (m^2/s^2) in the vertical plane B

The temperature fields and the distribution of velocity vectors and turbulence energy provide a significant knowledge of steel casting conditions, however, these characteristics do not directly explain of whether the tundish condition is suitable for nonmetallic inclusion removal or agitation processes in the sequential casting of different steel grades, or not. The answer to this question is provided by RTD (*Residence Time Distribution*) curves. For this purpose, model tests on water solutions or numerical modelling are most often carried out. These involve the addition of an appropriate amount of a tracer at the tundish gate, followed by recording tracer concentrations at the tundish strands during the process. Flowing through the tundish, liquid steel stays within it for a certain time which is called the theoretical (mean) residence time or nominal holding time of the fluid in the system, is calculated from the definition

$$\bar{t} = \frac{V}{\bar{V}}. \quad (15)$$

Practically, some liquid elements stay longer and some shorter than the theoretical residence time. Therefore, it becomes necessary to know the residence time distribution (RTD) for individual strands of a multi-strands tundish.

For this purpose, curves are plotted in dimensionless coordinates. Dimensionless concentration (corresponding to the coordinate Y) is defined as the ration of the current tracer concentration at the outflow to the average tracer concentration at the tundish inflow, in an ideal mixing condition.

$$C = \frac{c}{\bar{c}}. \quad (16)$$

The coordinate related to dimensionless time results from dividing the current steel flow-out time by the theoretical residence time (\bar{t})

$$\Theta = \frac{t}{\bar{t}}. \quad (17)$$

The analysis of the RTD curve enables the determination of basic parameters necessary for the evaluation of the characteristics of liquid flow in the tundish, namely:

$$\Theta_{\min} = \frac{t_{\min}}{\bar{t}}, \quad \Theta_{\text{peak}} = \frac{t_{\text{peak}}}{\bar{t}} \quad \text{oraz} \quad \Theta_{\text{av}} = \frac{t_{\text{av}}}{\bar{t}}. \quad (18)$$

The actual mean residence time (t_{av}) is estimated from the following relationship:

$$t_{\text{av}} = \frac{\int_0^{\infty} ctdt}{\int_0^{\infty} cdt} \cong \frac{\sum_i c_i t_i}{\sum_i c_i} \quad (19)$$

the time intervals of recorded concentration are identical in the entire testing range, being equal to $\Delta t=1s$. The range in which continuous recording was performed was 4000 s.

The following types of liquid flows can be distinguished in tundish flows: an ideal-mixing, plug, stagnant (dead) and a short-circuited flows, which are schematically illustrated in Figure 11.

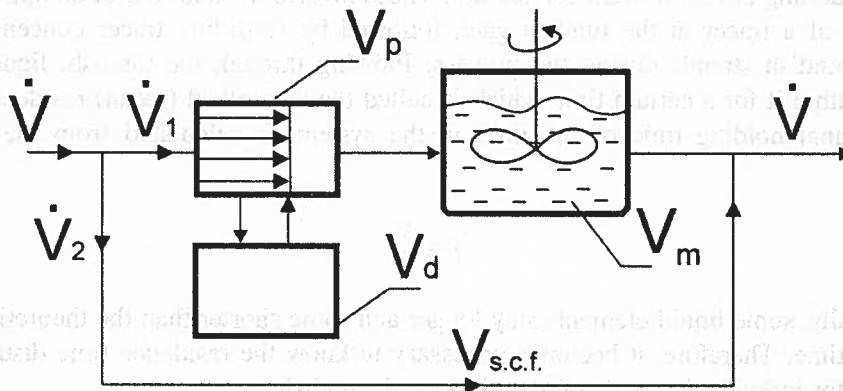

Fig. 11. Schematic representation of flow system

Using an RTD curve developed based on model tests and taking an appropriate theoretical description of liquid flow, individual flow shares or their proportions can be estimated for a particular tundish. Figure 12 shows characteristic cases of RTD curves for different flows.

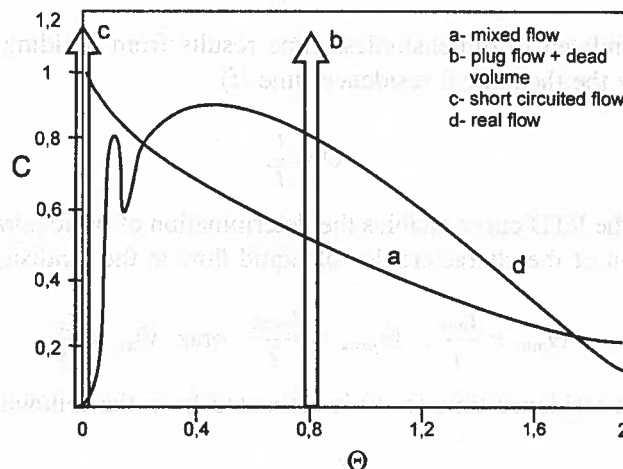

Fig. 12. C diagram for various types of RTD curves

For the purposes of this analysis, three different theoretical models are used: the mixed model [10], the modified mixed model [11, 12] and the so called combined mixed

model [13, 14]. It is hard to categorically judge of which of them is the most suitable for the analysis of flow, as each of them assumes a certain level of idealization. For the purpose of our own analysis, the mixed model was used, whereby three flow zones can be distinguished in the tundish volume, namely: a stagnant (dead) flow, a dispersion plug flow and an (ideal) mixing flow, whose volume fractions can be estimated from the RTD curve according to the following relationships:

$$V_d = 1 - \frac{\dot{V}_a}{\dot{V}} \Theta_{av} \quad (20)$$

$$V_{dp} = \frac{(\Theta_{\min} + \Theta_{\text{peak}})}{2} \quad (21)$$

$$V_m = 1 - V_d - V_{dp}. \quad (22)$$

The stagnant (dead) region is the one, in which the liquid moves very slowly and the time spent in it by the liquid is at least two times the mean residence time. Therefore, the fraction of this flow is calculated according to the proposal of [13], where the ratio $\frac{\dot{V}_d}{\dot{V}}$ is defined as a part of the area under curve C which is contained in the range from $\theta=0$ to $\theta=2$. Figure 13 shows RTD characteristics for individual nozzles of the tundish without a baffle, calculated based on the distribution of concentration of a single addition of a tracer

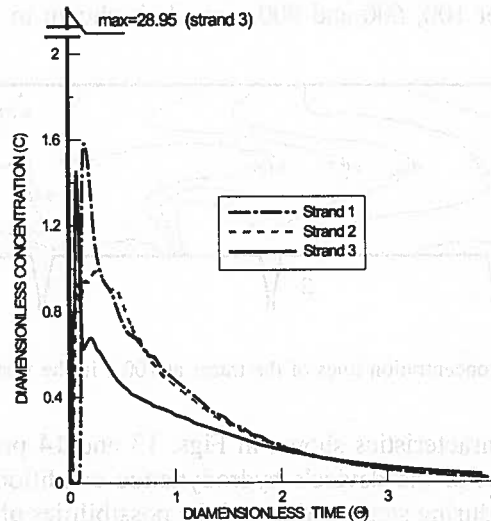

Fig. 13. Residence time characteristics for three nozzles of the tundish (without a baffle)

For the evaluation of the transition zone during casting different steel grades in a sequence, a characteristics was developed, which is depicted in Figure 14. Two different steel grades cast in a single sequence were simulated by the appropriate normalization

of marker concentration. In the first steel grade being cast the marker concentration was assumed to be equal to zero. After a certain period of time, the whole liquid in the tundish was replaced with a "new" steel grade that had the marker concentration at the tundish inlet equal to 1.

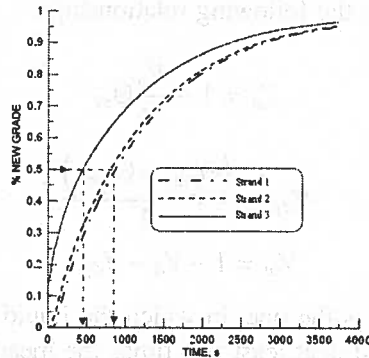

Fig. 14. Mixing time characteristics determined for three nozzles of the tundish

It can be read out from it in which period of the process (for each of the tundish strands) the steel grade being currently cast, as defined in terms of chemical composition, is prevailing. The spatial image (of plane B) of the formation of chemical composition within the tundish after 100, 600 and 900 seconds is shown in Figures 15-17.

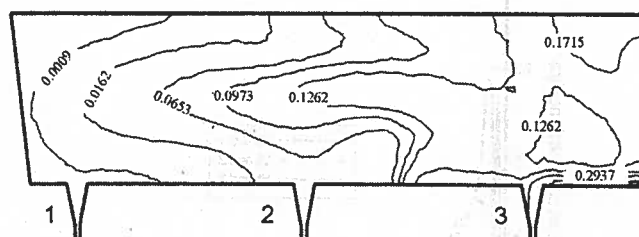

Fig. 15. Isoconcentration lines of the tracer at 100 s in the vertical plan B

The developed characteristics shown in Figs. 13 and 14 provide an initial, qualitative idea of the effect of the device's hydrodynamic conditions on the formation of chemical composition during steel casting and the possibilities of removing nonmetallic inclusions. It can be particularly clearly seen that the steel flowing out from strand no. 3 has very unfavorable conditions for nonmetallic inclusions to flow out to the slag (too short residence time). Detailed quantitative characteristics informing of the ranges of particular types of flow are given in Table 4. It is confirmed that for the original tundish (without flow modifiers) strand no. 3 has very unfavorable proportions of the shares of particular flow types.

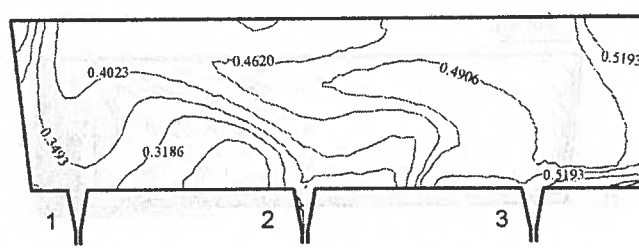

Fig. 16. Isoconcentration lines of the tracer at 600 s in the vertical plan B

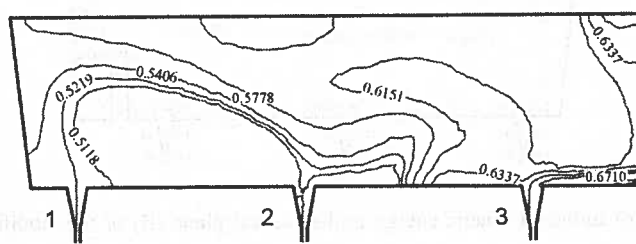

Fig. 17. Isoconcentration lines of the tracer at 900 s in the vertical plan B

Since the results of the analysis of the real facility indicate the necessity of introducing a modification to the internal construction of the tundish, a proposal was made to install additional dams between the pouring zone and the adjacent strands. A schematic diagram of the device model is shown in Figure 2.

For this device, calculations of the hydrodynamics of flow were performed again. Partial results of the calculation of the distribution of velocity vector fields, the isolines of the kinetic energy of turbulence and concentration characteristics are shown in Figures 18-22.

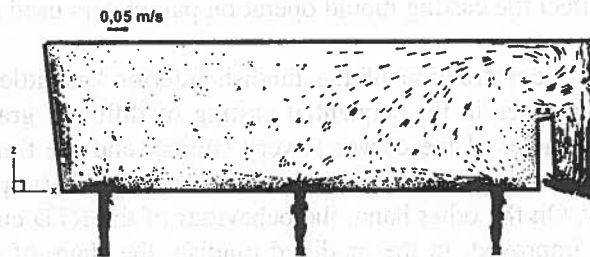

Fig. 18. Velocity (m/s) fields of steel (profiles) in vertical plane (B) of the modification tundish

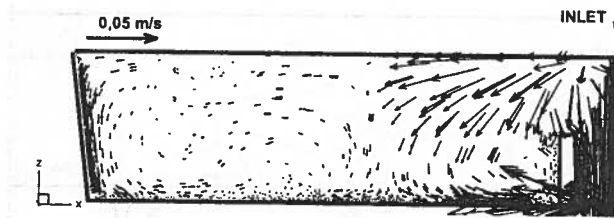

Fig. 19. velocity (m/s) fields of steel (profiles) in vertical plane (A) of the modification tundish

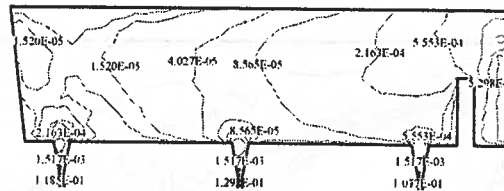

Fig. 20. Isolines of turbulent kinetic energy in the vertical plane (B) of the modification tundish

Velocities at the strands of two tundishes: the existing device and the device after proposed modification are juxtaposed below.

Average velocity [m/s] on outlet of tundish

TABLE 3

Number outlet	Outlet 1	Outlet 2	Outlet 3	average
Average velocity [m/s] for real tundish	2.55	2.55	2.56	2.55
Average velocity [m/s] for modify tundish	2.53	2.58	2.53	2.55

The presented steel flow-out velocity results (Table 3) indicate that the modified construction will not affect the casting mould operation parameters used so far during steel casting.

The performed reconstruction of the tundish interior has little affected the formation of transition zones in the sequential casting of different grades of steel (Fig. 14 and 22). The character of the curves is very similar, and the time after which the concentration of slabs being is determined by a new steel grade (at particular nozzles) differs only slightly. On the other hand, the behaviour of the RTD curve for strand no. 3 has substantially improved. In the modified tundish, the share of the plug flow has increased (from 0.8 to 9.6%), which is favorable to the process of nonmetallic inclusion removal, and the short-circuited flow, which was very significant (which is illustrated in Fig. 13), has disappeared. For the remaining tundish strands, the performed geometry modification (installing two dams) has not brought any significant changes (Table 4).

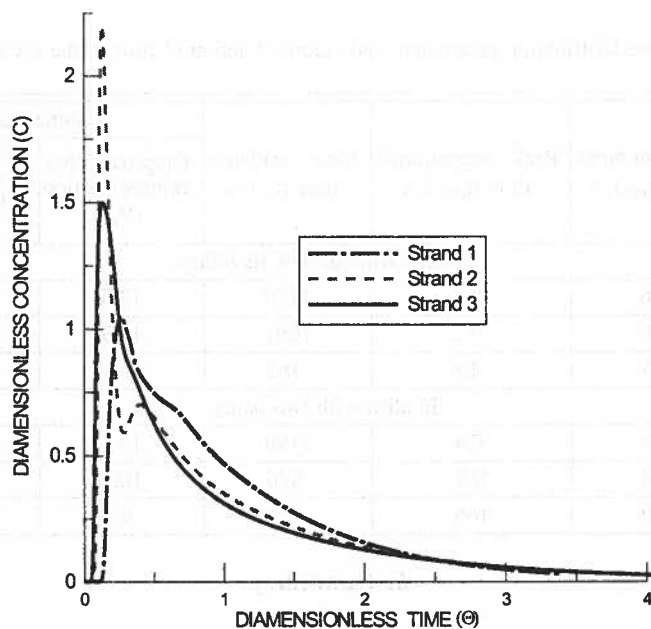

Fig. 21. Residence time characteristics for three nozzles of the modified tundish

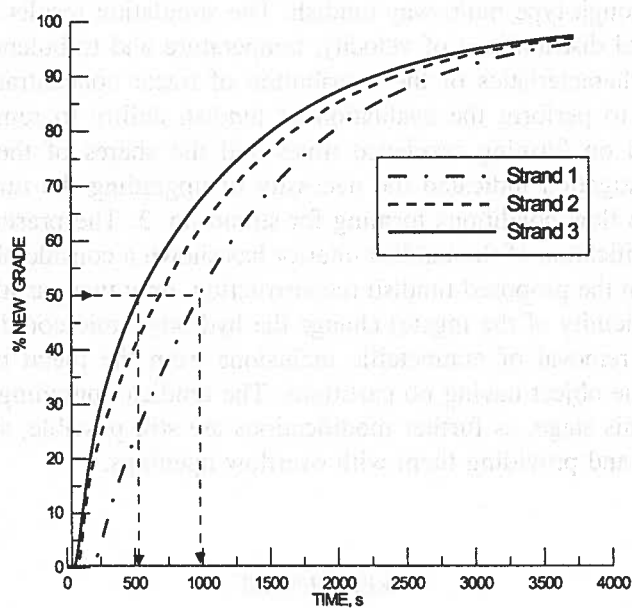

Fig. 22. Mixing time characteristics determined for three nozzles of the modified tundish

TABLE 4

Residence Time Distribution parameters and volume fraction of flow in the six strand tundish

Strand number	Minimum break time (t_{\min}), s	Peak concentration time (t_{peak}), s	Mean residence time (t_{av}), s	Volume fraction, %		
				Dispersed plug volume friction (V_{dp})	Well mixed volume friction (V_{m})	Dead volume friction (V_{d})
Tundish without flow modifiers						
1	96	204	1120	12,5	64,4	23,1
2	30	312	1061	14,3	56,8	28,9
3	5	15	782	0,8	54,7	44,5
Tundish with two dams						
1	144	324	1190	19,5	58,2	22,3
2	84	168	896	10,5	53,3	36,2
3	60	166	803	9,4	47,7	42,9

6. Summary

For developing the characteristics of flow in the steel continuous casting tundish and evaluating the effect of the modification of the internal tundish geometry on basic casting parameters, a numerical modelling technique was used. The subject of investigation was a trough-type multi-way tundish. The simulation results made it possible to obtain detailed distributions of velocity, temperature and turbulence energy fields, as well as the characteristics of the distribution of tracer concentration in the steel. It was possible to perform the evaluation of tundish ability to remove nonmetallic inclusions based on forming residence times and the shares of the plug and dead flows. The investigation indicated the necessity of upgrading the tundish interior, in particular due to flow conditions forming for strand no. 3. The presented preliminary proposal of modification of the tundish interior has shown a considerable improvement in this respect. In the proposed tundish reconstruction, only two partitions installed (in the immediate vicinity of the ingate) change the hydrodynamic conditions sufficiently to facilitate the removal of nonmetallic inclusions from the metal bath in a greater degree than in the object having no partitions. The tundish upgrading process has not to be ended at this stage, as further modifications are still possible, such as installing additional dams and providing them with overflow openings.

REFERENCES

- [1] J. Szekely, O.J. Ilegbusi, N. El - Kaddah, PCH PhysicoChemical Hydrodynamics, **3-4**, 1987, 453.
- [2] S. Joo, R.I.L. Guthrie, Metallurgical Transactions B, **24B**, 1993, 755.
- [3] D. Masumdar, R.I.L. Guthrie, ISIJ International **39**, 1999, 524.

- [4] J. Szekely, O.J. Ilegbusi, The physical and Mathematical Modeling of tundish operations, Springer-Verlag, New York, USA, 1989.
- [5] B.E. Launder, D.B. Spalding, Lectures in Mathematical Models of Turbulence, Academic Press, London, England, 1972.
- [6] S. Chakraborty, Y. Sahai, Metallurgical Transactions B, **2B**, 1992, 153.
- [7] S. Joo, J.W. Han, R.I.L. Guthrie, Metallurgical Transactions B, **24B**, 1993, 767.
- [8] LUENT User's Guide, Fluent Inc. 1998.
- [9] J.H. Ferziger, M. Peric, Computational Methods for Fluid Dynamics, Springer-Verlag Berlin 1996.
- [10] S.K. Sinha, K.M. Godiwalla, D.K. Shaw, Scandinavian Journal of Metallurgy, **30**, 2001, 103.
- [11] D. Mazumdar, G. Yamanoglu, R.I.L. Guthrie, Steel Research. **68**, 1997, 293.
- [12] S. Singh, S.C. Koria, ISIJ International **33**, 1993, 1228.
- [13] Y. Sahai, T. Emi, ISIJ International **36**, 1996, 667.
- [14] J. Palafox – Ramos, J.D.J. Barreto, S. Lopez – Ramirez, R.D. Morales, Ironmaking and Steelmaking **28**, 2001, 101.

Received: 4 October 2004.