

P. RANACHOWSKI*, F. REJMUND*, A. PAWELEK** , A. PIĄTKOWSKI**

MECHANICAL-ACOUSTIC AND STRUCTURAL INVESTIGATIONS OF DEGRADATION PROCESSES OF ALUMINOUS INSULATOR PORCELAIN C 130 TYPE

MECHANICZNO-AKUSTYCZNE I STRUKTURALNE BADANIA PROCESÓW DEGRADACJI IZOLATOROWEJ PORCELANY WYSOKOGLINOWEJ RODZAJU C 130

Presented paper aims to estimate the resistance of porcelain C 130 type to aging degradation processes during long-lasting period of exploitation. The objects of investigation were specimens made of high mechanical strength aluminous porcelain of C 130 type. This kind of material is used in the production of reliable electrotechnical elements such as insulators of overhead power lines. In case of the insulators not only high mechanical strength but especially elevated durability as well as operational reliability are required.

The paper comprises the results of microscopic, ultrasonic as well as acoustic emission (AE) measurements of samples subjected to slowly increasing compressive stress. It concerns problems connected with exploitation, production technology and ultrasonic measurements of specially prepared samples of porcelain. The samples prepared for examination were divided into three groups: first – without any defects, second – with faults of smaller or medium intensity, and third – containing numerous defects in structure. The acoustic parameters of not loaded samples and the ones loaded to various values of compressive stress were measured. Moreover, some of the specimens were additionally subjected to 200°C temperature action. This enabled verifying the insulator material resistance to temperature increase as a result of leakage currents.

The analysis of the obtained results revealed that the mechanism of ultrasonic wave propagation in porcelain of C 130 type is different from that in the case of typical aluminosilicate ceramic materials. This is the consequence of the effective reinforcement of the material structure by densely dispersed corundum and mullite phases in glassy matrix. Measurements of the attenuation coefficient offer better possibility to estimate the structure degradation of the porcelain material than velocity of ultrasonic wave propagation. Subsequently, the effect of the structural defects, introduced into the material, on the mechanical-acoustic behaviour and on the strength of the samples was presented.

The occurrence of the pseudoplasticity effect, directly proportional to the presence of technological defects in the structure of the material, was observed. The acousto-mechanical measurements were completed by microscopic analysis of the porcelain material. The phases' content was recognized. There were described the structures of samples belonging to three groups containing technological defects and with different advancement of material degradation. Presented results enable to draw up conclusions concerning the resistance of the ceramic material to the aging degradation processes development during long term exploitation.

Keywords: electrotechnical porcelain, compressive strength, structural degradation, acoustic emission, ultrasonic testing

Praca ma na celu ocenę odporności tworzywa rodzaju C 130 na procesy degradacji starzeniowej podczas wieloletniej eksploatacji. Obiekt badań stanowi porcelana wysokoglinowa rodzaju C 130 o dużej wytrzymałości mechanicznej. Tworzywo tego typu stosowane jest do produkcji odpowiedzialnych elementów elektrotechnicznych jak izolatory napowietrznych linii energetycznych. W przypadku tych wyrobów wymagana jest nie tylko duża wytrzymałość, lecz przede wszystkim wysoka trwałość i niezawodność.

Przedstawiono wyniki badań mikroskopowych, ultradźwiękowych oraz emisji akustycznej (EA) próbek poddanych wolno narastającym naprężeniom ściskającym. Omówione zostały zagadnienia eksploatacyjne tworzywa, technologia wytwarzania oraz badania ultradźwiękowe specjalnie wytworzonych próbek porcelany. Przygotowane próbki materiału podzielone zostały na trzy grupy – kształtki pozbawione wad technologicznych, próbki zawierające defekty strukturalne o mniejszym lub średnim nasileniu oraz kształtki posiadające liczne wady. Mierzone były parametry akustyczne próbek nieobciążonych oraz po przyłożeniu naprężeń ściskających o różnej wartości. Kilka próbek było ponadto poddanych działaniu temperatury 200°C. Miało to na celu sprawdzenie odporności tworzywa na temperaturę, podwyższoną w wyniku prądów upływu.

* INSTITUTE OF FUNDAMENTAL TECHNOLOGICAL RESEARCH, POLISH ACADEMY OF SCIENCES, 00-049 WARSZAWA, 21 ŚWIEŹOKRZYSKA STR., POLAND

** ALEKSANDER KRUPKOWSKI INSTYTUT OF METALLURGY AND MATERIALS SCIENCES, POLISH ACADEMY OF SCIENCES, 30-059 KRAKÓW, 25 REYMONTA STR., POLAND

Pomiary ultradźwiękowe wykazały, że mechanizm propagacji fal w porcelanie rodzaju C 130 jest odmienny niż w typowych glinokrzemianowych materiałach ceramicznych. Wynika to z występowania gęsto rozłożonych ziarn korundu oraz sieci drobnych igłowych kryształów mulitu w matrycy tworzywa wysokoglinowego. Badania ultradźwiękowe i mikroskopowe potwierdziły ważną rolę tych faz w strukturalnym wzmocnieniu materiału oraz wysoką odporność osnowy na powstawanie i propagację pęknięć. Stwierdzono, że pomiary współczynnika tłumienia dają lepszą możliwość oceny stopnia degradacji materiału w porównaniu do prędkości propagacji fal ultradźwiękowych.

Zasadniczą część pracy stanowią badania wpływu wprowadzonych do materiału wad struktury na charakterystykę mechaniczno-akustyczną oraz wytrzymałość mechaniczną próbek poddanych wolno narastającym obciążeniom ściskającym. Wyniki badań mechaniczno-akustycznych skorelowane zostały z analizą mikroskopową struktury próbek o różnym stopniu zaawansowania procesu degradacji materiału. Określono wpływ defektów technologicznych o różnym stopniu nasilenia na postępujący proces rozwoju mikropęknięć oraz szczelin. Dokonano oceny wpływu poszczególnych faz tworzywa na przebieg procesu degradacji struktury czerepu. Na podstawie przedstawionych badań sformułowano wnioski odnośnie odporności tworzywa na rozwój procesów degradacji starzeniowej podczas wieloletniej eksploatacji.

1. Introduction

Aluminous porcelain of C 130 type of high mechanical strength is at present widely applied in the production of reliable electroinsulating elements. This material is used to produce line insulators HV and EHV, HV post insulators, medium voltage (MV) line and post insulators of increased mechanical requirements, traction insulators and hollow insulators of high parameters [1-3]. In the case of these products, besides high mechanical strength, a long period of exploitation without breakdown is required. For several years there has been observed increasing tendency for the production of C 130 kind material, decreasing production of the quartz porcelain C 110, and to some extent also of aluminous material of C 120 type. This is the result not only of the present requirements concerning the short-term mechanical strength of the electroinsulating elements. It is more important to guarantee the reliability of power supply, which is determined by the durability, i.e. by the long-term mechanical strength of the ceramic material. Evaluation of the operating time of the material is based mainly on the analysis of the formation and development of ageing effects in the structure of the ceramic body.

The essence of the process of ageing degradation is a gradual expansion of the already existing microcracks and the formation of new ones under the influence of the structural mechanical stresses occurring in the material body. They represent the sum of internal stresses and stresses induced by the external factors [4, 5]. The internal stresses are created during the technological production processes, particularly at the last stage of firing, i.e. cooling. Then significant mechanical stresses are formed: in micro scale – on the boundaries of quartz grains and glassy matrix; in semi-macro scale – resulting from textural anisotropy and stresses in the macro scale between the internal and the external areas of the insulator rod, induced by the temperature gradient during the cooling process. Only the compressive stresses on the boundary between the ceramic body and glaze are intentional and increase the strength of the element. An insulator in

operation is subjected to considerable exploitation static stresses, as well as additionally – especially dangerous – dynamic loads coming from the cable vibrations. These stresses, when added to the intrinsic ones, accelerate the ageing processes. An additional factor contributing to the propagation of microcracks are the temperature changes in the body, attaining within day and night even as much as 45°C. In the case of the insulators of the older generation, long lasting periods of severe frost had a particularly destructive influence on the material [6]. They were responsible for sudden increase of failures on domestic power lines during the sharp winter of 1986/87.

The most important factor responsible for gradual degradation of the parameters of electroceramic material are the local stresses occurring at the grains, the interfacial boundaries and the alien inclusions in the ceramic body. The surface defects, which have essential influence on the strength of the samples, after correctly realized glazing are no longer important. Internal stresses in the micro-areas are located in the brittle medium. The only way of their relaxation is the increase of the already existing or occurrence of a new microcrack. Relaxation of stresses is thus connected with decrease of the mechanical strength of the material. However, the insulator in operation is under constant external load. As a consequence, the growth of microcracks causes gradual reduction of the cross-section area of the rod, which actually keeps up operational stress. Thus in the material under load there are present the internal stresses inducing constant increase of microcracks. Development of microcracks causes the degradation of the parameters of the material with the progress of time. As it is known, about 30 years long period of exploitation causes about 18% decrease of the mean mechanical strength of insulating material. The mechanical strength dispersion of the exploited insulators is, besides that, about 2.5 times greater than in the case of the new ones [7]. Degradation of the mechanical and electric parameters is of great importance, because as a consequence it decreases the reliability of power supply.

Experience obtained during exploitation of insulators made of aluminous porcelain of C 120 type has revealed a relatively quick development of the ageing processes. This refers to objects being in operation for some decades of years on domestic lines and power stations [5, 6, 8]. Occurrence of ageing processes in electro-porcelain structure has been also confirmed by foreign publications [4, 7]. The factor which has essential influence on the degradation of the material of this type with the progress of time is the high content of quartz, exceeding 20%. This component, existing often in the form of large grains, causes serious internal stresses in the porcelain body. Quartz phase sometimes shows also weak joint with precipitates of needle-shaped mullite. An additional problem is the dispersion of the properties, resulting from unsatisfactory repeatability of the parameters of technological processes. It was observed still in the nineteen-eighties.

In the case of material of C 130 type there is not enough experience obtained during a longer period of exploitation of the products. Although production of this porcelain in the domestic industry began in the year 1979 (material denoted E-15), it became widely applied only in the nineteen-nineties [9, 10]. Aluminous materials belonging to the triple system $K_2O-Al_2O_3-SiO_2$ have in general a similar composition of raw materials. In spite of that, the porcelains of C 120 and C 130 types differ from each other significantly in structure and the mechanical parameters. The results, obtained up to now, seem to indicate a different character of the development of cracks in the material C 130 in comparison with typical aluminosilicate materials (including porcelain of C 120 type). This is the result of effective reinforcement of the structure with the corundum and mullite phases. For these reasons, the results of investigation, carried out for other aluminosilicate materials, including the C 120 material [11, 12], cannot be applied to porcelain of C 130 type.

The presented paper constitutes a contribution in estimation the resistance of 130 type porcelain to the aging degradation processes during long-lasting period of exploitation. It should broaden the knowledge concerning the operational durability of the now produced electroinsulating elements. Especially that the applied composition of samples material did not differ from the porcelain of the currently produced insulators. On the other hand, a deaerating extrusion press of the older generation was used in the preparation of the samples. It caused the occurrence of structural defects found in some of the performed samples. As a consequence, the examined specimens were divided into three groups: first – without any significant defects, second – with defects of smaller or medium intensity, and third – containing

numerous defects in the structure of the samples. The research was intended to determine the influence of the presence and the intensity of the defects on the acoustic and mechanical parameters of the samples. Besides measurements at room temperature, there were carried out tests at the temperature 200°C. The investigations were aimed to test the effect of elevated temperature on the properties of the material. In operational conditions the increase of temperature occurs as a result of strong leakage currents.

2. Preparation of the samples for investigation

Specimens destined for acoustic measurements were prepared according to the technology typical for the production of ceramic parts of the insulators of overhead power lines. The laboratory deaerating extrusion press of an old type was used for plastic formation of raw ceramic material. The firing process of specimens was carried out in a large BICKLEY chamber furnace. The simplified scheme of the technological process of the samples fabrication can be presented as follows:

Preparation components of raw material → producing of plastic mass → formation → drying → firing (sintering) → final treatment.

Higher mechanical strength and smaller susceptibility of aluminous materials to ageing processes in comparison to classic 110 type porcelain are due to the substitute of quartz by alumina. Application of greater amount of Al_2O_3 , when connected with optimal proportion of other components of the mass and the production technology (especially firing process) results in the content of a greater amount of mullite in the material. This important phase occurs mainly in the form of precipitates containing needle-shaped crystals, less frequently – finer, scaly crystals. They improve the mechanical and electric parameters as well as the resistance of the material to ageing processes. Moreover, alumina dissolved in the glassy matrix effectively increases its mechanical strength by forming a skeleton – armament of fine needle-like crystals. Higher mechanical strength and the longer “life time” of C 130 type material in comparison to C 120 one is the consequence not only of the greater amount of Al_2O_3 content. First of all, this is the result of the application of a special kind of alumina – the so called ceramic – as one of the components of raw material. The grains of corundum ($\alpha-Al_2O_3$), present in great number in the structure of the material of C 130 type, efficiently play the role of dispersive strengthening. Corundum phase considerably increases the short- and

long-term mechanical strength and significantly slows down the ageing processes development. In the composition of the raw mass there was applied high content of ceramic alumina, which was the source of the corundum grains. Metallurgical alumina used in the mass of 120 type (about 20%), during the firing process undergoes reaction and is transformed into mullite. Thus it does not create the corundum crystals. The composition of the mass applied in this work was typical for electrotechnical aluminous materials of 130 type [1-3]. It comprised approximately 18% of kaolin, 22% of refractory plastic clays, 20% of feldspar fluxes and 35% of ceramic alumina. The cullet constituted 5% of raw ceramic mass.

The specimens were prepared in the form of cylinders with the diameter $\phi = 9.7$ mm. For the ultrasonic measurements a group of samples with the length equal also to 9.7 mm, was cut out from the specimens. To enable precise ultrasonic measurements in the transverse axis of the samples, the lateral surfaces were ground off on both opposite sides. In this way two parallel planes with the accuracy of 0.1 mm were obtained. The form and dimensions of the samples were conditioned by acousto-mechanical tests which were performed apart from ultrasonic measurements.

3. Ultrasonic measurements

Propagation of ultrasonic waves belongs to the mechanical wave phenomena with frequencies greater than the upper limit of audibility of the human ear (above 16 kHz). Conditions of the propagation of acoustic waves are determined by the properties of the medium in which they propagate. In the case of solid bodies they depend on their elastic parameters and the structural configuration. This offers the possibility of non-destructive examination the properties of the medium. This is of special value in the case of objects in which the optical methods cannot be used in the investigation. The ultrasonic wave is defined as the phenomenon of transferring a vibrating motion.

In general, it can be said that all ultrasonic methods applied in the investigations of ceramic and metallic materials are based mainly on accurate measurements of the time of transition of the ultrasonic impulse through the examined sample or object. The examined parameters may be the velocity of various types of ultrasonic waves (longitudinal, transversal, superficial, flexural) and the damping of waves. In a solid, continuous, homogeneous medium there propagate independently two plane waves: a longitudinal wave at the velocity c_L and the transversal wave $c_T = 0.5 \div 0.6c_L$. The longitudinal wave is a particular case of dilatational, vortex-free wave, consist-

ing in local changes of the density of the medium. The transversal wave corresponds to the shear wave, consisting in the formation of vortices without the change of the density of the medium. In the description as the starting point there must be taken the basic equation for the wave propagation in a medium in the following form:

$$\rho \frac{\partial^2 u}{\partial t^2} = \left(K + \frac{1}{3}\mu \right) \text{grad div} u + \mu \nabla^2 u, \quad (1)$$

where ρ denotes the density of the medium, u – shifting of the medium, Lamé's constants: K – modulus of volume elasticity, and μ – shear modulus. For isotropic media, in which ultrasonic elastic wave is propagating, two simple equations of propagation, for longitudinal and transversal waves, can be obtained.

In the technological applications the elastic properties of materials are defined by Young's longitudinal modulus of elasticity E and Poisson's number ν . When considering elasticity within the range of particles, the pair of the elasticity moduli are called the Lamé's coefficients. Lamé's coefficients are derived directly from the wave equations.

From the relations for ultrasonic waves propagation there may be derived the velocities of the longitudinal and the transversal waves for isotropic media, to which the metallic and ceramic materials belong. These dependences are defined in Lamé's coefficients and in the technical constants:

$$c_L = \sqrt{\frac{3K + 4\mu}{3\rho}} = \sqrt{\frac{E(1 - \nu)}{\rho(1 + \nu)(1 - 2\nu)}} \quad (2)$$

and

$$c_T = \sqrt{\frac{\mu}{\rho}} = \sqrt{\frac{E}{\rho 2(1 + \nu)}}. \quad (3)$$

After transformation of the above dependences formulae for Young's elasticity modulus and for Poisson's number are expressed in the form [13, 14]:

$$E = \frac{\rho c_T^2 (3c_L^2 - 4c_T^2)}{c_L^2 - c_T^2}, \quad (4)$$

$$\nu = \frac{c_L^2 - 2c_T^2}{2(c_L^2 - c_T^2)}, \quad (5)$$

where ρ denotes the density of the material, c_L – velocity of the propagation of longitudinal waves, c_T – velocity of the propagation of transversal waves.

When measuring the velocity of the propagation of ultrasonic waves it is assumed that the medium is perfectly elastic. Then the potential elastic energy passes

without loss into the kinetic energy of the vibrating motion of the medium particles. In reality, however, mainly as a result of dispersion at the wave reflection from the heterogeneities and internal friction, part of the energy is lost. In the case of multi-phase materials the effects of diffraction and dispersion on the material heterogeneities such as microcracks, pores, phase boundaries are significant. Special importance have the areas of internal stresses [13, 14, 15]. As a result the intensity of the wave decreases with the distance, which means that it is damping. Accordingly, the amplitude of the registered signals diminishes and their sinusoidal form is disturbed. In the present study, there were carried out measurements of the attenuation coefficient α . Its value depends on the parameters of the microstructure, the physical properties of the medium and the frequency of the ultrasonic waves. The attenuation coefficient α (in dB/cm) was calculated from the formula [15]:

$$-\alpha = \frac{8,686}{l} \log \frac{A_2}{A_1}, \quad (6)$$

where A_1 denotes the amplitude of the impulse after first reflection, A_2 – the amplitude of the impulse after second reflection, l – distance passed by the impulse. The value of damping is usually treated as a positive quantity. Since A_2 is smaller than A_1 – a change of the sign is applied.

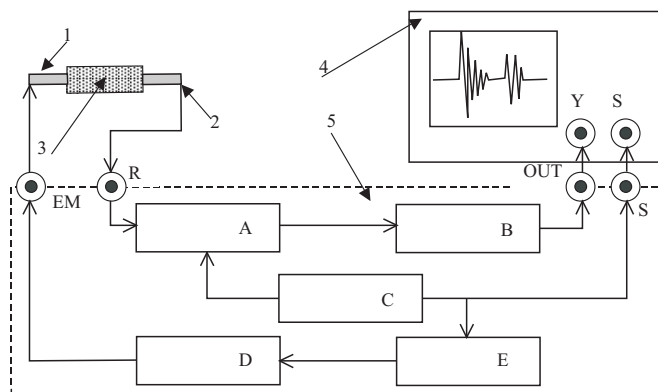

Fig. 1. The block diagram of the set-up: 1,2 – transducers, 3 – material sample, 4 – digital oscilloscope, 5 – transmitting-receiving module, A – key signal preliminary amplifier, B – voltage amplifier, C – controlling and synchronizing system (timer), D – power amplifier, E – key impulse generator

The ultrasonic measurements were carried out by means of a specially constructed set-up for the investigation of ceramic elements, including those of large dimensions (long rod-insulators). This measuring set-up, constructed at the Institute of Fundamental Technological Research of Polish Academy of Sciences (IFTR PAS), comprises a transmitting – receiving module, digital oscilloscope Tetronix TDS 210, mechanical system of co-axial holding down of ultrasonic heads to the sample

and a set of ultrasonic transducers for longitudinal and transversal waves. The scheme of measuring system is presented in figure 1 and general view – in figure 2.

The technique of investigation is described in detail in [16]. For better distinguishing of the damping coefficients of the material samples with various degree of defectiveness, heads for longitudinal waves of higher frequency equal to 10 MHz were used. The frequency of standard transducers is in the range 4÷6 MHz. In the case of transversal waves the applied heads had the standard frequency equal to 2 MHz. For the reason of small samples dimensions, as reliable can be recognized only results of velocities measurements of not loaded samples and specimens with low degree of defectiveness.

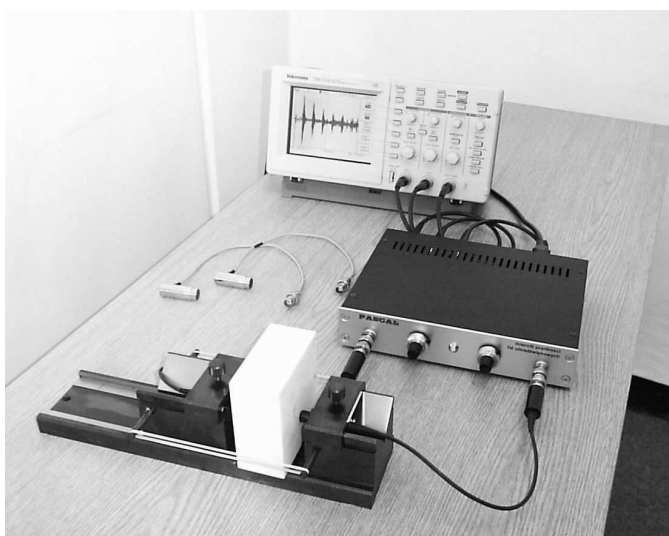

Fig. 2. View of a set-up for ultrasonic measurements of ceramic samples. The acoustic testing of a large corundum specimen is shown as an example

On the basis of the measurements of c_L and c_T velocities, general homogeneity of the material could be estimated as satisfactory. The velocities of the longitudinal c_L and the transversal c_T waves, measured along the lengthwise axis of specimens, were in the range 7030÷7060 and 4160÷4180 m/s, respectively. The values of Young's modulus E , calculated on the basis of equation (4), were equal to 117-118 GPa (density of the material $\rho = 2.75 \text{ g/cm}^3$). In the crosswise direction of samples the dispersion of the registered acoustic wave velocities was considerably higher, c_L within the range 6670÷6770 m/s and c_T in the interval 3930÷4000 m/s, respectively. The values of Young's elasticity modulus determined from these data were in the interval 104.5÷108.5 GPa. The uncertainty of measurements for c_L and c_T was ± 20 m/s, whereas for the calculated values of Young's modulus was about ± 1.5 GPa. Carrying out of these measurements was difficult because of small dimensions of the samples. The obtained values

are evidently better than the parameters registered for material C 130 of power system insulators. This is the consequence of simpler production technology of small specimens (parameters of formation, drying and firing). The material of smaller samples as a rule demonstrates greater density, lower porosity and smaller defects content in comparison to the material of HV insulators (scale effect).

The values of the damping coefficient α , measured for all samples in the lengthwise direction, showed relatively high values and significant dispersion – about $1.0 \div 1.9$ dB/cm. Damping in the crosswise direction of the specimens was as a rule even higher – from 1.7 to over 3.5 dB/cm. Elevated values of the damping coefficient indicate the presence of non-homogeneities or regions with internal stresses in the structure of the majority of samples. They can be easier registered in the crosswise direction. The effect of clearly marked one-directional anisotropy is typical for ceramic elements formed using the plastic method and deaerated in extrusion press.

It has been found that the defectiveness of the porcelain structure, even in a degree considerably affecting the cohesion of the material, causes only a relatively small reduction of the velocity of ultrasonic waves. This is due to the presence of densely distributed corundum grains in the porcelain structure and to the numerous fine, needle shaped mullite crystals dispersed in glassy matrix. These two phases facilitate the propagation of ultrasonic waves even in the case of strong degradation of the material structure. The effect of this was only a moderate increase of the damping coefficient measured even for samples with high degree of defectiveness. It should be emphasized that the factor which seriously troubled the measurements and had a substantial influence on the obtained results, especially of α coefficient, was the small dimensions of samples. Hence the values of the amplitude damping coefficient should be considered only as approximate.

Samples belonging to the first group (without structural defects), after loaded up to 880 MPa, show the values of velocities of wave propagation c_L and c_T on almost unaffected level. However, the values and the dispersion of the damping coefficient were increased. In the longitudinal axis the α parameter ranged $2.5 \div 3$ dB/cm, whereas in the crosswise direction it was equal to about 3 dB/cm. A greater increase of damping was registered for a sample from the first group, loaded up to 1144 MPa. Value of damping coefficient in the longitudinal axis was increased to about 4 dB/cm, and in the crosswise direction – to about 5 dB/cm.

In the case of a specimen from the second group (smaller or medium structural faults), loaded up to 758

MPa, a clearly marked increase of α coefficient, to the range of about $4.5 \div 6.5$ dB/cm, was observed. Besides increase of its value, there should be noticed the great dispersion of this parameter. Moreover, a stronger damping (about 6 dB/cm) was recorded in the crosswise direction of the specimen. In the case of a sample from the second group, subjected to stress of 250 MPa – after the preliminary stage of structure degradation, a relatively small increase of α coefficient was observed. In the longitudinal axis it was higher than 3.7 dB/cm and in the crosswise direction it amounted to about 4 dB/cm. Similar effects were registered for a sample from the second group, loaded up to the value of 824 MPa at temperature 200°C. The occurrence of defects in the structure of the sample, mainly large pores, was also reflected in the shape of the registered signals.

Ultrasonic investigations of a sample from the third group (containing numerous defects in structure), loaded to the critical stress range – 747 MPa, confirmed the presence of serious structural faults. In the longitudinal direction of the specimen the measured value of the damping coefficient increased to $6 \div 7$ dB/cm. Carrying out of a reliable measurement in the crosswise direction of the sample was not possible. This was the consequence of strong deformation and the absence of repeatability of the obtained ultrasonic signals.

Measurements carried out for porcelain of 120 type and other aluminosilicate materials showed even higher increase of damping coefficient of defected material [11, 12]. A distinct decrease – about 200 m/s – was found also for the velocity value of longitudinal wave propagation c_L . Drop of c_T value was a bit smaller. However, these investigations were carried out using the standard heads, of the frequency equal to 4.7 MHz, in case of the longitudinal waves.

It should be said that the mechanism of ultrasonic wave propagation in porcelain of 130 type differs from that in the case of typical aluminosilicate materials. The mechanism of the growth of defects during increasing compressive load is also different. This is the consequence of the effective reinforcement of the material structure by corundum and mullite phases.

4. Mechanical-acoustic investigations

The method of acoustic emission is a valuable tool when used for monitoring internal structural changes in ceramic materials. This technique allows to obtain numerous data concerning the dynamic processes occurring during change of mechanical, thermal or thermo-mechanical stresses [17, 18]. This is the more essential that AE signals appear already at the thresh-

old stresses when the generation of microcracks in the material cannot be in practice detected by other methods.

Investigation of ceramic aluminosilicate and of corundum materials allowed to state that the number of AE events is a good measure of the intensity of cracking which constitutes the microscopic process of the destruction of a sample [18, 19]. The correlation between the velocity of a fissure growth and the rate of AE events is particularly useful. Recording of this AE descriptor allows to monitor the destruction process of the material under mechanical load. The events rate and the energy of AE signals, however, are not in general a linear function of changes of the mechanical or thermal stresses. The velocity of these changes is an additional factor influencing the acoustic activity, which is difficult to define quantitatively. The measurement of the AE events rate as a descriptor, at a slow increase of mechanical load (of the order of 10^{-2} mm/min) allows, however, to make the AE investigations almost independent of the influence of other factors on the degradation process of the material. This has been confirmed by the authors during the investigation of porcelain and cordierite materials [11, 20, 21].

Mechanical-acoustic tests were carried out using specially constructed two-channel measuring system – figure 3. The mechanical channel contained testing machine INSTRON 6025 with computer control. The steel base on which the sample was placed functioned simultaneously as an acoustic waveguide. In the investigation the velocity of the traverse of the machine equal to 0.02 mm/min was applied. Simultaneously with the measurement of the load acting on the sample, in the second channel AE descriptors were recorded. The acoustic measurement path contained a broad band transducer

WD PAC type (passband $80 \div 1000$ kHz), preamplifier, AE analyser constructed at the Institute of Metallurgy and Materials Science of the Polish Academy of Sciences and a computer. Six seconds time interval of summing up the signals, total amplification equal to 88 dB and the threshold voltage of the AE analyser (discrimination level) 1.19 V were applied. The rate of counts, the events rate and the energy of AE signals were recorded. As it has been mentioned above, the most valuable information for the evaluation of the examined processes of material degradation is offered by AE events rate. Hence the registered courses of AE activity were analysed by means of this descriptor.

Mechanical-acoustic measurements confirmed separation of the examined samples into three groups. The degree of defectiveness of the structure of a porcelain material has a significant influence on the acoustic characteristics of a specimen subjected to increasing mechanical load. Recognition of the stages of material structure degradation was possible on the basis of comparative investigation using microscopic and ultrasonic techniques.

Four samples, denoted as the first group, during the whole process of compression at room temperature, showed low AE activity. These specimens did not contain any technological defects of structure. For these samples the occurrence of the stage of continuous AE activity was not observed. Only single signals at different stress values unique for each sample were recorded. These signals had as rule small amplitude. Strong AE effects appeared only in the short interval, directly preceding the destruction of the specimen. This interval was called the critical one. The destructive stresses for two samples from the first group, which were loaded till complete destruction, were 1225 and 1251 MPa. Samples,

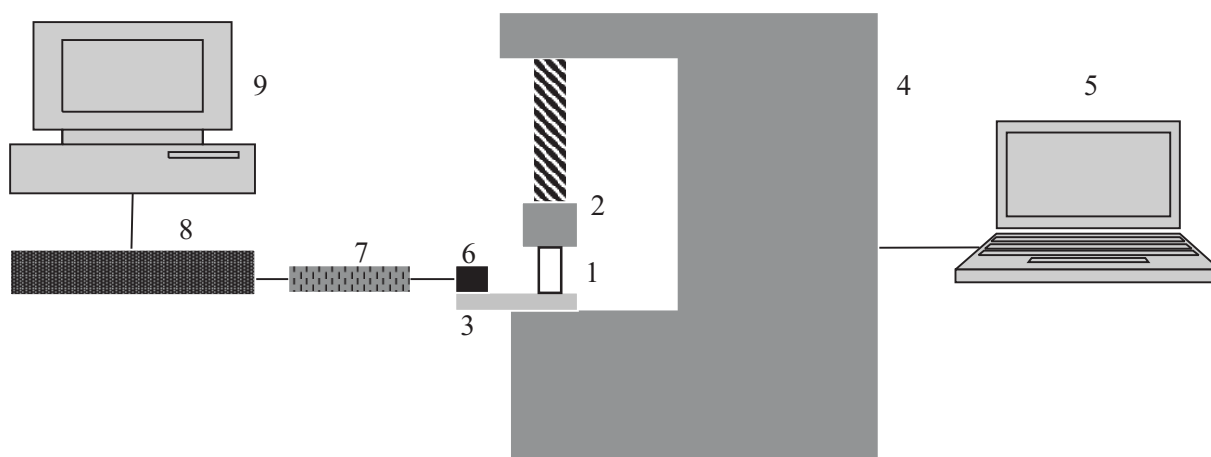

Fig. 3. Scheme of a double-channel measuring system for mechanical-acoustic investigation of the ceramic samples: 1 – specimen, 2 – traverse of the testing machine, 3 – steel base, 4 – testing machine, 5 – computer controlling INSTRON machine, 6 – AE transducer, 7 – preamplifier, 8 – AE analyser, 9 – computer recording AE descriptors

belonging to this group, loaded at the temperature 200°C, showed most often a similar acoustic characteristics and their mechanical strength were equal to 990, 1120 and 1353 MPa. In the case of these specimens, however, the occurrence of AE signals of different intensity and responding to diverse levels of stress was observed. Figure 4 shows the typical course of the rate of AE events as a function of compressive stress for a sample from the first group, loaded at room temperature. Figure 5 shows the dependence of AE RMS rate (root mean square) versus stress for a sample loaded at the temperature 200°C. Its destructive stress value was the highest from among all the examined specimens – 1353 MPa. In the case of this sample worth to note was low acoustic activity in a wide range of stresses and a critical AE stage of high energy and short duration.

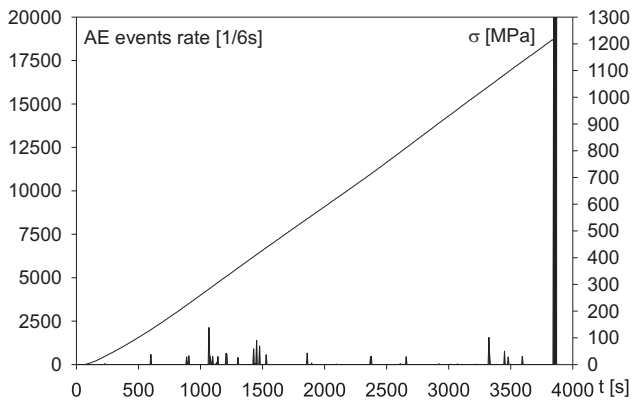

Fig. 4. Course of the rate of AE events as a function of compressive stress for a sample from the first group, which became destroyed at the stress 1225 MPa. Investigation was carried out at room temperature

From among 6 specimens of the second group, 5 samples were examined at room temperature and one at the temperature 200°C. These samples contained technological defects which resulted in decrease of mechanical strength of the material. In the case of these samples a noticeable initial stage of acoustic activity was observed which occurred within the range from about 20 up to over 230 MPa. The continuous AE effect of the initial stage for some samples of second group disappeared already at the stress of about 100 MPa. The amplitude of AE signals for particular samples was differentiated. Generally, it can be stated that the amplitude of signals was on a level typical for other aluminosilicate materials as porcelain C 120 type and cordierite [11, 20, 21]. After the preliminary stage of AE activity there were registered only single signals, mainly of low amplitude. Only at stresses exceeding 600 MPa some of the samples generated the signals of stronger amplitude. A high level of AE activity was registered at stresses preceding from a few to some tens of megapascals the failure of the sample. This relatively short stage of acoustic ac-

tivity, defined as a critical one, was characterized by less differentiated and a considerably higher intensity in comparison to the preliminary stage.

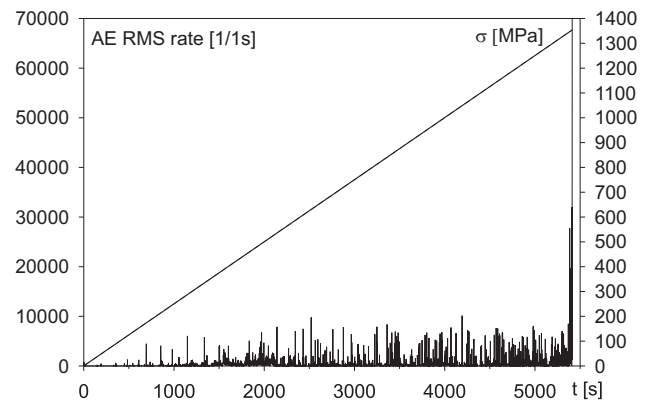

Fig. 5. Course of the rate of RMS AE events as a function of increasing compressive stress for a sample from the first group tested at the temperature 200°C. The destructive stress was equal to 1353 MPa

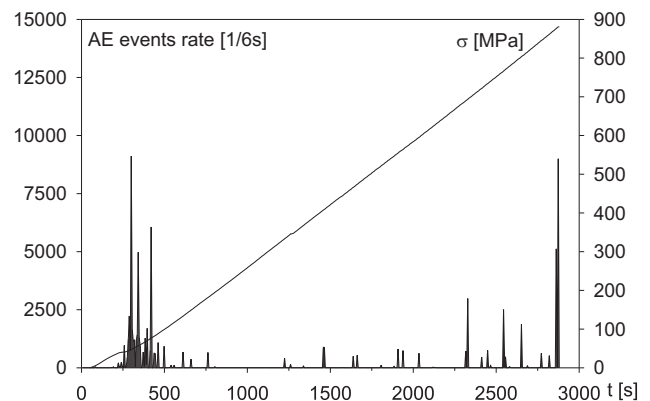

Fig. 6. Course of AE events rate as a function of compressive stress for a sample from the second group, which was destroyed at 881 MPa. Investigation was carried out at room temperature

The strength of three destructed samples of the second group, measured at room temperature, was 713, 881 and 918 MPa. The increase of the stress for one sample examined at the temperature 200°C was stopped at the value equal to 824 MPa. It was probably close before the sample failure. Figure 6 presents the typical course of the rate of AE events, as a function of the compressive load, for a sample from the second group ($\sigma_{max} = 881$ MPa), examined at room temperature. Figure 7 shows RMS AE rate for a sample loaded at the temperature 200°C, up to the stress value equal to 824 MPa. In the case of this specimen the numerous signals appearing in a wide range of stresses were registered. The acoustic characteristic of the sample was similar to that of a specimen from the first group, loaded at the temperature 200°C – Figure 5. This is evidence of easier cracking and separation of quartz grains from the matrix at higher

temperature. The parameters of the matrix, determining the mechanical strength of the whole sample, however, did not show any change. The corundum grains and the precipitates of mullite remained well coupled with the matrix, which demonstrated high resistance to cracking process. Thus, increased temperature had no essential effect on the final mechanical strength of the samples.

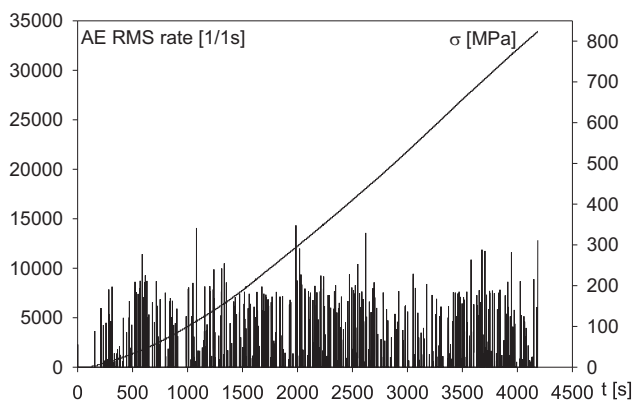

Fig. 7. Course of the rate of RMS AE as a function of increasing stress for a sample from the second group, loaded at the temperature 200°C. The increase of stress was stopped at the value of 824 MPa

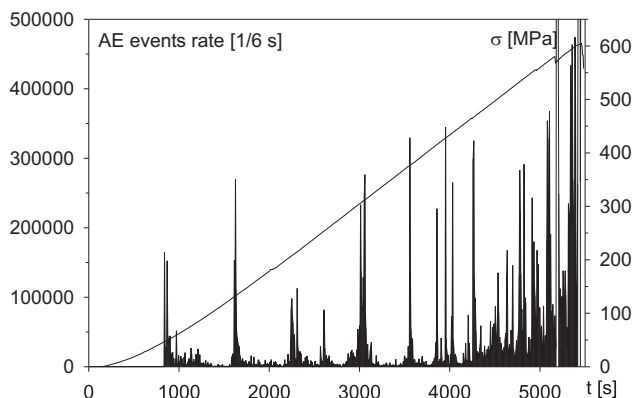

Fig. 8. Course of AE events rate for a sample from the third group which was destroyed at the stress 604 MPa. The continuous acoustic activity and the high level of AE effect can be observed

The samples, denoted as the third group, were characterized by relatively high AE activity in a wide range of stresses. In the case of these samples there were observed three stages: the initial stage occurring up to about 200 MPa, the interval, defined as subcritical – differing in the range and AE intensity of the particular samples, and the final – critical stage, directly preceding the destruction of the specimens. The strength of the samples compressed up to failure was 604 and 647 MPa. Figure 8 shows the course of acoustic activity for a specimen which was destructed at lower stress. Serious structural defects were responsible for a substantial reduction of mechanical strength of the samples – about 50%. Although the defects were serious in the scale of the rela-

tively small dimensions of the specimens, their strength was anyway high, exceeding the values obtained for samples of porcelain C 120 type [11, 20] and cordierite material [21].

Samples from each of the three groups were remained for ultrasonic and structural investigation. Two samples from the first group, compressed up to 880 and 1144 MPa were taken for further ultrasonic and microscopic investigation. In the case of specimens qualified to the second group – one sample was loaded up to 758 MPa – to the occurrence of a strong AE activity which was the beginning of the critical stage. The loading of the second one was stopped at 250 MPa – after the preliminary stage of acoustic activity. Also a sample examined at the temperature 200°C, for which the compressing was stopped at the value 824 MPa, was taken for ultrasonic and microscopic examination. From samples of the third group, for further investigation there was selected a specimen loaded up to stress equal to 747 MPa. This sample showed a strongly marked preliminary stage and the sub-critical one. The stress was stopped already during the critical stage, close before reaching the destructive value.

5. Microscopic investigation

Carrying out microscopic investigation of the samples of the material required careful preparation of the areas of observation. Analysis of the structure required the use of a special procedure of preparing the polished sections. The specimens subjected to high compression stresses had to be especially carefully cut and polished. Due to the use of a special saw with finer graining of disc the standard grinding of the examined surfaces was not necessary. After cutting preparation procedure contained slight etching in H_2F_2 solution, rinsing, drying, polishing using colloidal silica in presence of NaClO as well as subsequent rinsing and drying.

The optical microscope (OM), coupled with the computer image analyzer CLEMEX, was used. The applied power of the objective ranged from $\times 10$ to $\times 20$, which corresponds to the resolution ranging from 0.3 to 0.1 μm .

Phase analysis of samples enabled to qualify the material as a typical aluminous porcelain of high strength C 130 type [1-3]. The investigated structure was very similar to that observed in electro-technical engineering products, e.g. insulators of overhead power lines. The dominating crystal phase was fine-grained corundum, in amounts of about 19%. It occurred in the form of elongated grains, of a few micrometers in size. Quartz grains with the diameter of $15 \pm 6 \mu\text{m}$ occupied about

8% of the surface of the polished sections. The actual content of this phase, however, was slightly higher, because some part of quartz grains, was crushed out during the course of preparing the polished sections. The grey background constituted the glassy-mullite matrix of the content more than 65%. Fine-crystalline mullite was hardly distinguished from the matrix. The glassy matrix contained a lattice of fine needle-like crystals of mullite. They formed its “armament” – substantial fibrous structural strengthening of matrix. Greater, needle-like crystals of mullite formed big precipitates, usually of regular shape. Their size was of the order of $50 \div 100 \mu\text{m}$ and they represented about 25% of the material. The spatial distribution of mullite precipitates was often inhomogeneous. The porosity of the samples varied in the range from 0.9 to 2.2%. Thus, it was lower than in the case of typical material of 130 type. The size of pores did not exceed 10 μm , most often their size was in the range $2 \div 5 \mu\text{m}$. They had a regular, rounded shape. In the samples of the second, and especially of the third group, the presence of large pores (above $20 \mu\text{m}$) and usually of non-uniform distribution, was observed. They occurred most often inside and in the peripherals of big, macroscopic bands having characteristic dark colour – Figure 9. The dark bands contained first of all the precipitates of mullite. The presence of the bands, together with non-uniform distribution of the phases inside them, is regarded as a textural defect. In the neighbourhood of the bands there were also observed characteristic fissures. It should be emphasized that the revealed defects were of big dimensions, especially in comparison to small size of the samples.

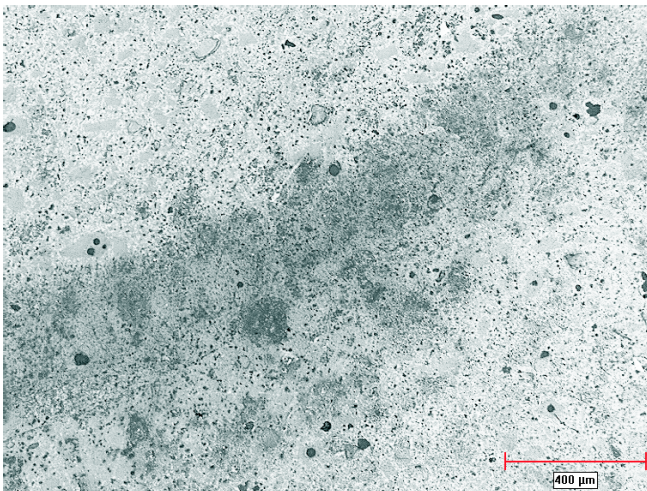

Fig. 9. Image of the structure of the material of a sample from the third group magnified 50 \times . The textural defect is clearly visible as a dark band

Grains which fell out during surface preparation represented a few percent of the polished sections. This

effect appeared especially in samples which were subjected to compressive stresses. Presence of textural inhomogeneities was the consequence of incorrect operation of the deaerating extrusion press. The differences in the occurrence and the intensity of the structural defects in the samples resulted in diverse mechanical-acoustic characteristics and the mechanical strength of specimens belonging to different groups.

Investigation of sample from the first group, loaded up to the value of 1144 MPa, revealed the presence of more substantial cracks only in its central part. Length of cracks was about $250 \mu\text{m}$ and they occasionally branched out. However, they were rather few and they could not be regarded as critical defects. There was also observed the presence of peripheral cracks around quartz grains as well as inside and around of some precipitates of mullite – figure 10. High, exceeding 1200 MPa, strength of specimens of the first group was consequence of their homogeneous structure. The content of big pores was not higher than 0.3%, there were no textural defects or fissures. For samples of first group distribution of crystal phases and pores in the glass-mullite matrix could be recognized as correct. AE activity, registered in a wide range of stresses for samples from the first group, examined at the temperature 200 $^{\circ}\text{C}$, was not enough strong – figure 5. It was mostly connected with propagation of peripheral and inner cracks of the quartz grains.

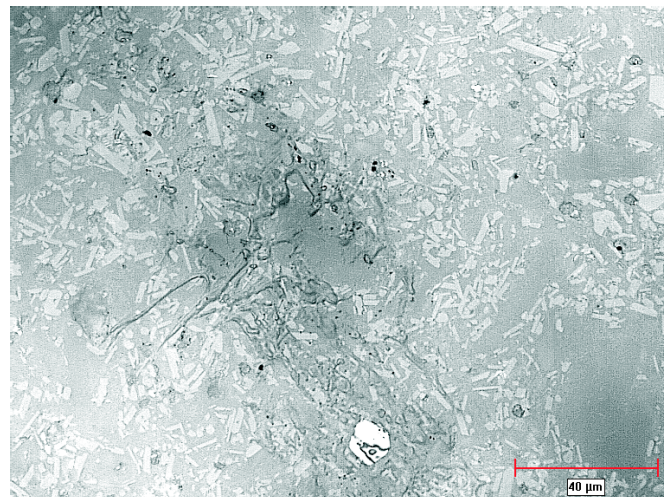

Fig. 10. Structural image of the peripheral part of a sample from the first group, loaded up to 1144 MPa, magnified 500 \times . Cracks of a big precipitate of mullite are visible

The effects of structure degradation observed in a sample from the first group, loaded up to 880 MPa, and in a specimen from the second group, loaded up to 758 MPa, were similar. In the peripheral areas of the samples were observed only cracks around the quartz grains and – considerably less often – around the precipitates of mullite. Bigger quartz grains contained also inner cracks.

In the central part of the specimens stresses were cumulated. They induced more serious effects of degradation in the form of longer, occasionally branching out cracks. They were growing up through all phases of the ceramic material. The cracks were observed also inside some of mullite precipitates.

In the material of a sample from the second group, loaded up to 758 MPa, the content of big pores was greater than 0.5% and their distribution was not uniform. The same concerned also the precipitates of mullite and quartz grains. A small number of elongated fissures were also present. These defects were the basic source of intensive generation and growth of microcracks during the preliminary stage of AE. Nevertheless, strong structural reinforcement hampered their further growth. At sufficiently high stresses (of about 700÷900 MPa) rapid increase of the arrested cracks took place. It resulted in AE activity of the critical stage. Figure 11 shows the structure of the central part of the described sample from the second group. Big precipitates of mullite and long cracks are well visible.

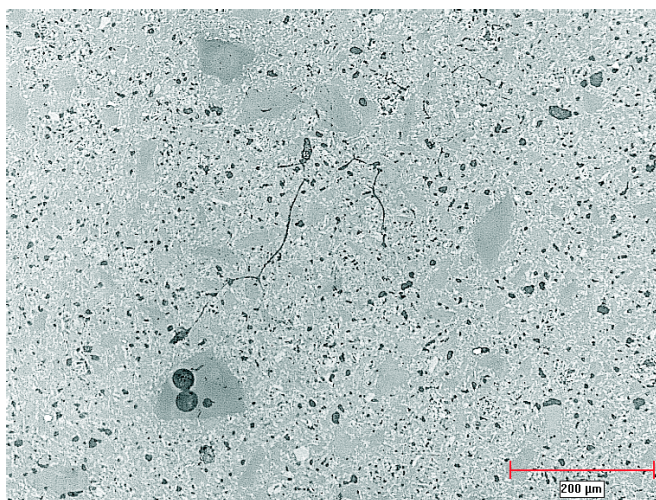

Fig. 11. Image of the structure of the central part of a sample from the second group, loaded up to the beginning of the critical stage of AE (758 MPa), magnified 100×

It should be marked that the structural defects of samples from the second group, considerably favoured the formation and growth of cracks. Their threshold energy was not high and the effects of the propagation of these cracks corresponded to the preliminary stage of acoustic activity of the samples. Such cracks were observed in specimen from the second group after loading up to 250 MPa. Separation of part of the quartz grains from the matrix and inner cracks in some, especially bigger grains, was observed there. In the case of mullite precipitates, the peripheral cracks were definitely less frequent.

In the case of the sample from the second group, loaded up to 824 MPa at the temperature 200°C, the presence of only few microcracks in the neighbourhood of structural inhomogeneities was observed. The peripheral and inner cracks in the precipitates of mullite were rarely observed and only in the central part of the specimen. Numerous AE signals, registered in a wide range of stresses, corresponded to degradation of the quartz phase. It was found that a definite majority of quartz grains, independently of their size, underwent crushing out during preparation of the polished sections. Dark areas of various size and shape represented about 12÷15% of the examined surfaces. At the most 2.5% of this amount constituted the pores. Under the influence of external stress, at elevated temperature, the quartz phase was almost completely damaged. The grains became separated out from the matrix and cracked inside. The occurrence of bigger cracks of subcritical size, which propagate through all the phases of the porcelain, was then not observed. The structure of the material of this sample is shown in figure 12.

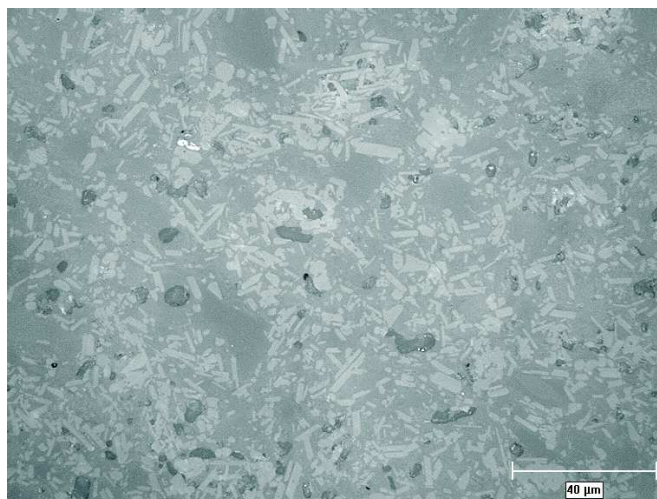

Fig. 12. Image of the structure of the material of a sample from the second group, loaded up to 824 MPa at the temperature 200°C, magnified 500×

Microscopic investigation carried out for many fragments of the samples from the third group revealed the presence of serious structural defects. They were the more essential that the length of the observed dark bands reached up to 1000 μm – figure 9, in the scale of the sample size with the height and diameter of about 1 cm. Besides defects of textural nature (elongated, dark bands) the effects of agglomeration, fissures and big pores were observed. They were present most often at the boundaries of dark bands and were the source of significant internal stresses. The concentration of these defects was considerably higher than in the case of samples from the second group and their distribution was

more non-homogeneous. The mean content of big pores with a diameter of some tens of micrometers was just about 1.5%. The non-homogeneous distribution of big pores as well as quartz grains and the precipitates of mullite should be emphasized. Especially in the macroscopic areas of dark bands and in their neighbourhood the concentration of big – of about 50 μm – precipitates of mullite was found. Some of them were even longer than 100 μm . They contained sometimes big pores inside (figures 9 and 11). On the other hand, corundum phase was homogeneously distributed, in the form of fine, elongated grains.

Investigation of a sample from the third group, loaded up to 747 MPa, revealed a considerable number of cracks, especially inside and at the boundary of the dark bands – figure 13. The generation and the development of cracks occurred particularly in the areas of defect-ed structure, characterizing strong internal stresses. The cracks often initiated from the fissures and big pores. Numerous cracks grew up already at moderate external loading. The threshold energy of this process was low. Hence, they were the source of acoustic signals in wide range of stresses, starting from the preliminary stage of AE activity – figure 8. Higher external loading generated number of large cracks, especially in the central part of the sample, where the stresses became cumulated. These cracks, visible in figure 14, had already a subcritical character and they propagated through all the phases of the porcelain material.

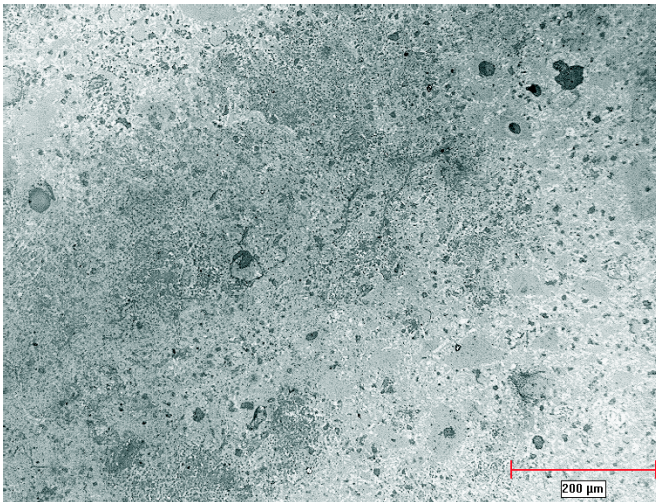

Fig. 13. Structural image of the material of a specimen from the third group, loaded up to the value 747 MPa, magnified 100 \times . Macroscopic areas of a dark band with long cracks and places after crushed out grains

Considerably reduced strength – even by 50% – and high acoustic activity of samples of the third group were the result of improper homogenization of the raw ceramic body. Investigation revealed that the decrease

of mechanical strength is result of textural defects – the macroscopic, dark bands and accompanying them big pores and fissures. Non-homogeneous distribution of quartz grains and the precipitates of mullite have a definitely smaller influence on the mechanical parameters of the samples. On the other side corundum phase represented very effective, dispersive strengthening of the porcelain material, being gathering of densely distributed energy thresholds for the elongating microcracks. Important is also high strength of the glassy matrix, resulting from a fibrous reinforcement with a network of fine needle-shape crystals of mullite. Their role in the matrix can be compared with function of reinforcement bars in concrete. As a result, even the samples of the third group, containing macroscopic structural defects, showed relatively high, exceeding 600 MPa, compression strength.

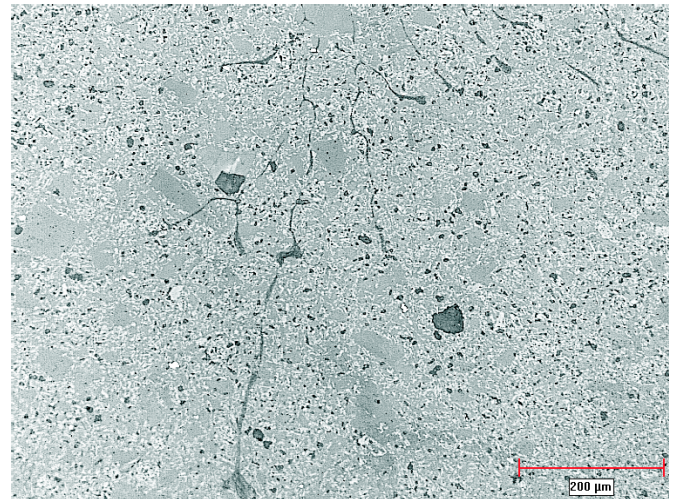

Fig. 14. Structural image of the material of the central part of a specimen from the third group, loaded up to the value 747 MPa, magnified 100 \times

The mechanical parameters of the examined samples did not decrease at the temperature 200°C. It seems that elevated temperature facilitates the processes of the separation of quartz grains from the matrix and favours their cracking inside. It has not any evident influence on the glassy-mullite matrix and on its bonding with the corundum crystals. Thus, elevated temperature does not affect structural elements determining the strength of the ceramic material. This confirms the effectiveness of the dispersive and fibrous mechanism of strengthening of aluminous porcelain C 130 type structure, also at higher temperature.

6. Summarizing remarks

The object of complex mechanical-acoustic, microscopic and ultrasonic investigations were samples made

of aluminous porcelain C 130 type. At present it is one of the most important materials used in electrical engineering. It is widely applied for the production of elements with required high durability and operational reliability – first of all power lines insulators and hollow insulators. The relatively short period of exploitation of products, made of the material C 130 type, has not yet allowed obtaining sufficient information about the processes of aging degradation in the porcelain of this type. The used method and results of investigation has an innovative character. They demonstrate significant analogy between the structural effects during long period of exploitation and compressive stresses acting on the material in a laboratory test of relatively short duration, carried out on small specimens.

Part of the samples had contained technological defects, mainly of textural character and of various degree of intensity. This allowed examining the influence of the defects on the process of structural degradation of the material under increasing compressive stress. It was found that the presence of areas of high internal stresses favours the generation and propagation of cracks, which causes the decrease of the strength of the samples by some tens of percent. This refers to areas with disturbed texture as well as containing fissures and densely distributed large pores. The non-homogeneities of the distribution of mullite precipitates and particularly of quartz grains, which relatively easily undergo separation from the matrix and internal cracking, are definitely less important. The mechanical strength of the material is determined primarily by the properties of the glassy matrix, containing a lattice of fine, needle-shaped crystals of mullite and densely distributed fine grains of corundum. Obtained results prove that all the stages of the complex production technology of the material 130 type have influence on its operational parameters. Particularly important stages are: suitable selection of raw materials, properly performed firing process, correct plasticization as well as homogenization of raw ceramic body, especially during deaeration in extrusion press.

The effectiveness of dispersive and fibrous reinforcement of the structure of aluminous porcelain C 130 type was confirmed. It should be emphasized, that even samples containing significantly defected structure as well as macroscopic faults, demonstrated high compressive strength, exceeding 600 MPa. However, this means decrease of strength of about 50%, in comparison to specimens without defects. The mechanical parameters of the samples were not reduced at the temperature of 200°C either. Results point at facilitated process of separation of the quartz grains from the matrix and their cracking inside at elevated temperature. Larger precipitates of mullite easier undergo degradation either. All this, how-

ever, has no evident influence on the factors determining the strength of the material – the glassy-mullite matrix and its joining with the corundum grains. It means that even a considerable current leakage, which increases the temperature of the material, should not have any greater influence on the “life time” of an insulator.

Application of the mechanical-acoustic method enabled an evaluation of the homogeneity of the specimen material, even without additional microscopic study. Using the ultrasonic technique was hindered because of the presence of densely distributed corundum grains, forming “channels” characterized by high velocity of the wave propagation. The glassy matrix, containing the numerous fine, needle shaped mullite crystals, also constitutes a medium of relatively high velocity and low damping of ultrasonic waves. As a result, even a high degree of the structure defectiveness has a relatively slight influence on the worsening of the acoustic parameters of the material. The process of degradation of the material structure is visibly reflected only in the increase of damping. The decrease of the velocity of ultrasonic waves propagation is small and it does not properly reflects the deterioration of the parameters of aluminous material.

Samples of C 130 material, containing minimal amount of internal defects and characterized by high mechanical strength, correspond to a model of ideal brittle body. The growth of microcracks, facilitated due to the presence of inhomogeneities, is responsible for the occurrence of pseudoplasticity effect. This phenomenon was found in the samples of the second group and it was distinct in the specimens of the third group. Increased temperature facilitates internal cracking and the separation of the quartz grains from the matrix. Degradation of the mullite precipitates is also facilitated but to a smaller extend. These processes result in intensification of pseudoplasticity effect.

REFERENCES

- [1] IEC Publication 672-1:1995 Ceramic and glass- insulating materials, Part 1: Definitions and classification.
- [2] IEC Publication 672-2:1999 Ceramic and glass- insulating materials, Part 2: Methods of test.
- [3] IEC Publication 672-3:1997 Ceramic and glass- insulating materials, Part 3: Specifications for individual materials.
- [4] W. Carty, U. Senapaty, Porcelain – Raw Materials, Processing, Phase Evolution and Mechanical Behavior, *J. Am. Ceram. Soc.* **81** [1], 3-20 (1998).
- [5] J. Dziadkowiec, E. Kupiec, Procesy starzeniowe w izolatorach ceramicznych, *Energetyka* **5**, 166-170 (1992).

- [6] W. Czaplak, Analiza uszkodzalności izolatorów długopniowych i możliwości ich użytkowania w sieciach 110-220 kV, *Energetyka* 11, 69-73 (1987).
- [7] J. Liebermann, Avoiding Quartz in Alumina Porcelain for High-Voltage Insulators, *American Ceramic Society Bulletin* 80, 6-7, 37-48 (2001).
- [8] P. Ranachowski, F. Rejmund, M. Jaroszewski, J. Fleszyński, Ultradźwiękowa diagnostyka ceramicznych izolatorów liniowych po wieloletniej eksploatacji, *Przegląd Elektrotechniczny*, 1'2005, X Sympozjum Problemy Eksploatacji Układów Izolacyjnych Wysokiego Napięcia, Krynica, 211-214 (2005).
- [9] J. Gajewski, A. Majewski, Wytrzymałość mechaniczna nowych typów wysokonapięciowych izolatorów ceramicznych produkcji ZPE "ZAPEL" S.A., *Prace Naukowe Instytutu Podstaw Elektrotechniki i Elektrotechnologii Politechniki Wrocławskiej*, Nr 32, Seria: Konferencje, Nr 9, Mat. Konf. NIWE'97, 13-18 (1997).
- [10] Data made available to authors by ZAPEL S.A. Company in Boguchwała near Rzeszów.
- [11] P. Ranachowski, F. Rejmund, A. Pawełek, A. Piątkowski, Structural and acoustic investigation of the quality and degradation processes of electrotechnical insulator porcelain under compressive stress, *Proc. of AMAS Workshop on Nondestructive Testing of Materials and Structures II NTM' 03, IFTR PAS Warsaw*, 179-196 (2003).
- [12] P. Ranachowski, F. Rejmund, A. Pawełek, A. Piątkowski, Structural and Acoustic Measurements of Aluminous Porcelain under Compression Load, 14, *Molecular and Quantum Acoustics* 23, 363-376 (2002) Gliwice.
- [13] I. Malecki, *Physical Foundations of Technical Acoustics*, Pergamon Press, Oxford, Chapter 3 (1969).
- [14] H. E. Ryli-Nardzewska, J. Ranachowski, Ultradźwiękowe badania właściwości sprężystych tworzyw ceramicznych, W książce pod red. Ranachowski J.: *Elektroceramika – wybrane metody badań*, tom. 2. PWN, Warszawa-Poznań, 35-48 (1982).
- [15] A. Śliwiński, *Ultradźwięki i ich zastosowania*, Wydawnictwo Naukowo-Techniczne, wydanie drugie, Warszawa, rozdziały 2 i 4 (2001).
- [16] P. Ranachowski, W. M. Rećko, Urządzenie do precyzyjnych pomiarów prędkości propagacji fal ultradźwiękowych i współczynnika tłumienia w tworzywach ceramicznych, *Szkło i Ceramika* 54, 4, 15-18 (2003).
- [17] J. Ranachowski, F. Rejmund, Emisja akustyczna w ceramice technicznej, w: *Emisja Akustyczna – Źródła Metody Zastosowania*, red. Malecki I., Ranachowski J., wyd. Biuro PASCAL, Warszawa, 55-107 (1994).
- [18] J. Ranachowski, I. Malecki, Możliwości oceny pseudoplastyczności materiałów ceramicznych metodą emisji akustycznej, w: *Nowe Kierunki Technologii i Badań Materiałowych*, Praca zbiorowa pod red. Ranachowski J., Raabe J., Petrovski V., Wydawnictwo IPPT PAN, Warszawa, 35-46 (1999).
- [19] A. S. Evans, T. G. Langdon, Structural Ceramics, in: *Progress in Materials Science*, red. Chalmers S., Christian J. W., Massalski T. S. 21, Pergamon Press, 171-441, (1976).
- [20] P. Ranachowski, F. Rejmund, A. Pawełek, A. Piątkowski, Structural and Acoustic Measurements of Aluminous Porcelain under Compression Load, 14, *Molecular and Quantum Acoustics* 23, 363-376 (2002).
- [21] P. Ranachowski, F. Rejmund, A. Pawełek, A. Piątkowski, Akustyczne i strukturalne badania tworzywa kordierytowego przy naprężeniach ściskających, *Mat. LI Otwartego Seminarium z Akustyki OSA'2004, Gdańsk-Sobieszewo*, 195-200 (2004).