

A. GONTARZ\*, Z. PATER\*, K. DROZDOWSKI\*

## FORGING ON HAMMER OF RIM FORGING FROM TITANIUM ALLOY Ti6Al4V

### KUCIE NA MŁOCIEODKUWKI FELGI ZE STOPU TYTANU Ti6Al4V

This paper presents the research results of hammer forging process of a plane wheel rim forging from titanium alloy Ti6Al4V. The research works were divided into two stages. The first concerned the theoretical analysis based on numerical simulations of the worked out forging technology. Distributions of temperature, strain, damage criterion according to Cockcroft-Latham, material flow kinematics and force parameters were evaluated. It was stated that the danger of overheating and material cracking in the forging does not exist. Large force values present in the process means that problems with tools durability may appear. Satisfactory results of the theoretical analysis provided the basis for conducting the second stage of the research works, that is experimental tests in industrial conditions. After dies making forging tests were made in one Polish forging plants, in which a product of good quality was obtained. Manufactured forgings were free from cracks, shape faults and fulfilled requirements concerning mechanical properties.

*Keywords:* Hammer forging, Rim, titanium alloy Ti6Al4V

W artykule przedstawiono wyniki badań procesu kucia na młocie odkuwki felgi koła samolotowego ze stopu tytanu Ti6Al4V. Prace badawcze podzielono na dwa etapy. Pierwszy dotyczył analizy teoretycznej opartej na symulacjach numerycznych opracowanej technologii kucia. Dokonano oceny rozkładu temperatury, odkształcenia, kryterium zniszczenia według Cockrofta-Lathama, kinematyki płynięcia materiału i parametrów siłowych. Stwierdzono, że nie zachodzi niebezpieczeństwo przegrzania i pęknięcia materiału w odkuwce. Duże wartości sił występujących w procesie świadczą o możliwości występowania problemów z trwałością narzędzi. Pozytywne wyniki analizy teoretycznej dały podstawę do przeprowadzenia drugiego etapu badań tj. prób doświadczalnych w warunkach przemysłowych. Po wykonaniu matryc przeprowadzono próby kucia w jednym z polskich zakładów kuźniczych, w których uzyskano wyrób charakteryzujący się dobrą jakością. Wykonane odkuwki pozbawione były pęknięć, wad kształtu i spełniały wymagania odnośnie własności mechanicznych.

### 1. Introduction

Titanium alloys are very attractive material for application in aviation, biomedical and naval industries as well as in transport, petro chemistry, building, for production of domestic equipment and many more. Such a wide application is connected with good mechanical properties at relatively small mass density, good resistance to corrosion, possibility of exploitation in increased temperatures. At enlarging constantly demand for titanium alloys, research works on material saving technologies, which include metal forming technology, are extremely important. It is worth noticed that relation of purchased material mass to mass of parts produced from titanium alloys at planes constructing is 8:1 [1, 2]. Hence, research works on these alloys forging processes are justified. In specialist literature a lot of papers

are published concerning the issue of titanium alloys. Part of them deals with their acting during deformation in various conditions [3-5]. However, there are less papers concerning these materials forming technologies. Among them those dealing with isothermal forging of titanium alloys [6], near net shape forming technology [7, 8] or strains in state of superplasticity can be distinguished [9].

The most widely spread alloy is the alloy Ti6Al4V, which constitutes 50% of all titanium alloys applications in industry [5]. The Authors of this paper have undertaken research works on this alloy forging with large velocities. The results of research works, which aimed at working out technology and manufacturing of plane wheel rim forging from titanium alloy Ti6Al4V by means of forging on die hammer are presented in this paper.

\* LUBLIN UNIVERSITY OF TECHNOLOGY, NADBYSTRZYCKA 36, 20-618 LUBLIN, POLAND

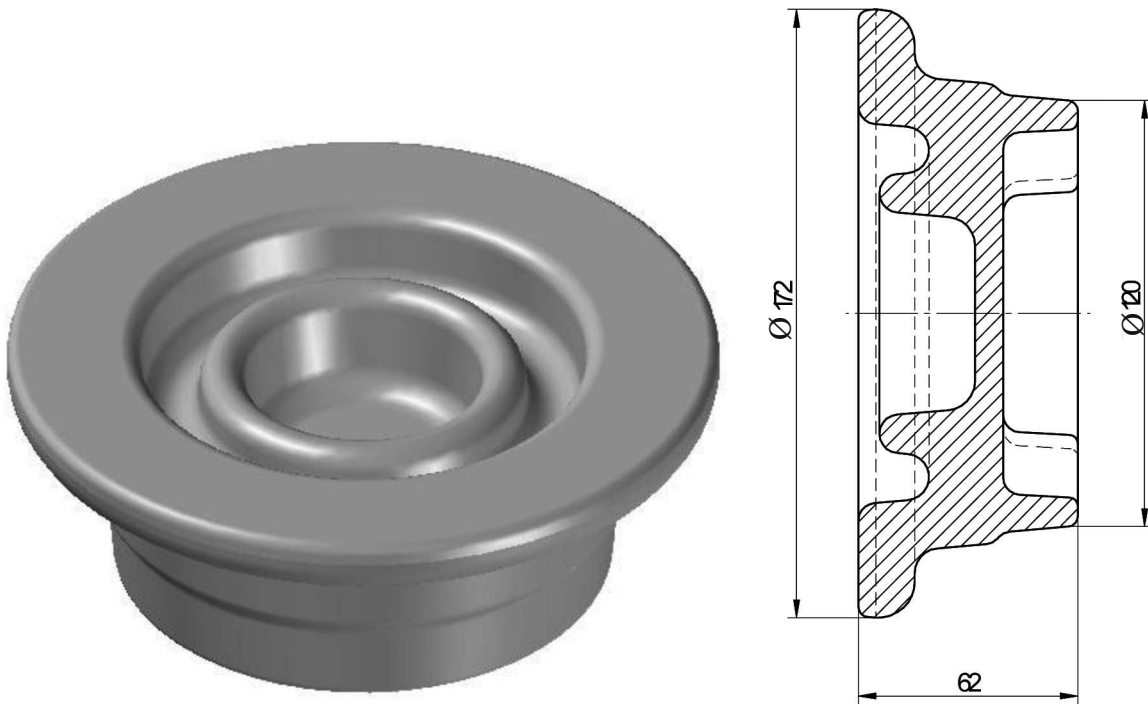

Fig. 1. Model of rim drop forging

## 2. Theoretical analysis

Presented issues concern the forging process of a plane wheel rim forging. The part was designed by a team from Aviation Institute in Warsaw. On the basis of a finished part, the drop forging draft was worked out (Fig.1) and the forging process was designed, which included the following operations:

- material cutting to the dimension  $\text{Ø}100 \times 93$  mm,
- billet heating to the temperature  $930^\circ\text{C}$ ,
- upsetting and initial forging,
- control of the preform quality,
- preform heating to the temperature  $930^\circ\text{C}$ ,
- forging in the final impression,
- flash trimming,
- control of the forging quality.

The first stage of research was theoretical analysis based on numerical simulations, which were made with the application of DEFORM-3D software. The following parameters were assumed in calculations: billet temperature  $930^\circ\text{C}$ , tools temperature  $250^\circ\text{C}$ . In numerical calculations were considered thermal phenomena present in the formed material in the result of heat transfer into the environment and tools as well as the result of change of plastic deformation work and friction work into heat. It was taken for granted that heat transfer coefficient between material and tools was equal  $10 \text{ kW} \cdot \text{m}^{-2} \cdot \text{K}^{-1}$ , between material and the environment this coefficient was equal  $0.02 \text{ kW} \cdot \text{m}^{-2} \cdot \text{K}^{-1}$  and friction factor in constant friction model was 0.59 [10]. The formed material

model was taken from the library of the used software. It was assumed that the rim forging would be forged on hammer MPM 10000 which stroke energy was 110 kJ, the mass of the hammer ram was 3000 kg and stroke efficiency was 0.8.

For the calculations needs geometrical model was created, which consisted of two rigid dies (lower and upper) and billet modeled by means of 4-noded hexahedral elements.

### 2.1. Forging in initial die impression

On the basis of initial simulations, it was assumed that at the beginning an upset part of height 70 mm would be formed. It was, however, stated that without appropriate upsetting operation at the further stage of forging overlapping appeared. The formed upset part was next forged in initial die impression. At such chosen forging parameters 4 strokes of hammer were needed in order to form a preform. During numerical modeling of the forming process, it was assumed that after each stroke the forging would be cooled by 1 s in the bottom die.

Particular stages of forming in initial dies together with temperature distributions were illustrated graphically in Fig. 2. It is well visible that in the result of the upper tool pulse acting, layers of material adhering the tool are strongly heated. The temperature increase is observed mainly in the forging surface area, which can mean that it is the result of friction work change in-

to heat. During breaks between strokes heat abstraction takes place from the heated surface layer into the forging, which leads to decrease of the temperature diversity. At the same time the temperature in the areas of forging adhering the bottom die decreases. Due to that fact the forging formed on hammer is characterized by a large temperature diversity.

Strain intensity distribution in the forging volume is also interesting (Fig. 3). From the data presented in this figure is well seen that material flows more intensively in the forging upper part formed by the upper die. This confirms suggestion that in the case of forging on hammer, material flows more superficially than in the case

of forging on press and the flow is more intensive in the area of upper tool impression.

The analysis of cracks appearance was also made, basing on normalized damage criterion according to Cockroft-Latham, which distribution is shown in Fig. 4. As it can be noticed the integral representing this criterion assumes small values. Cracks may appear in flash.

Percussive character of forming on hammer is reflected in tools load, which may wear out quickly. It should be also noticed that the force value in the last stroke is large, which corresponds with large values of surface pressures, which, additionally, act in a cyclic way.

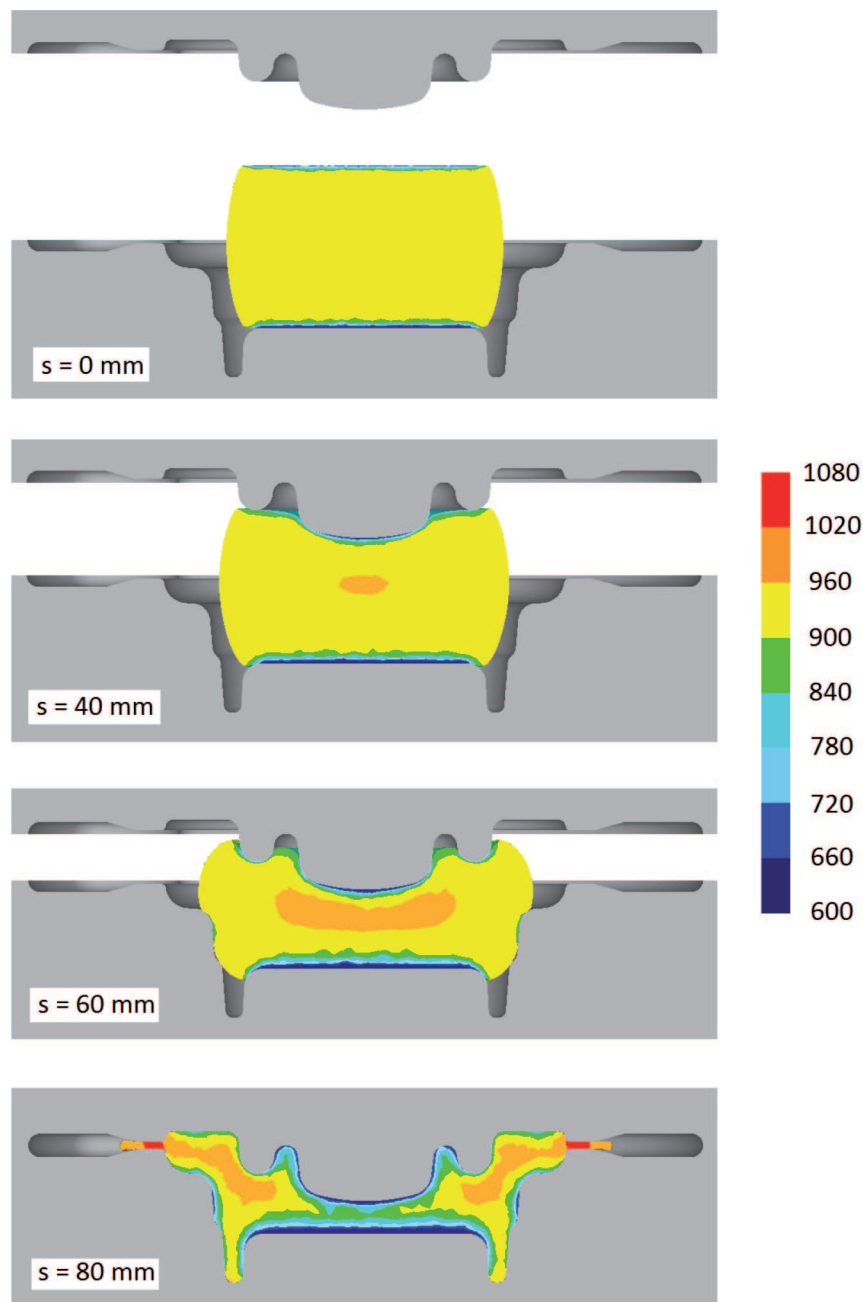

Fig. 2. Changes of temperature in a rim forging (in °C) during hammer forging in initial impression

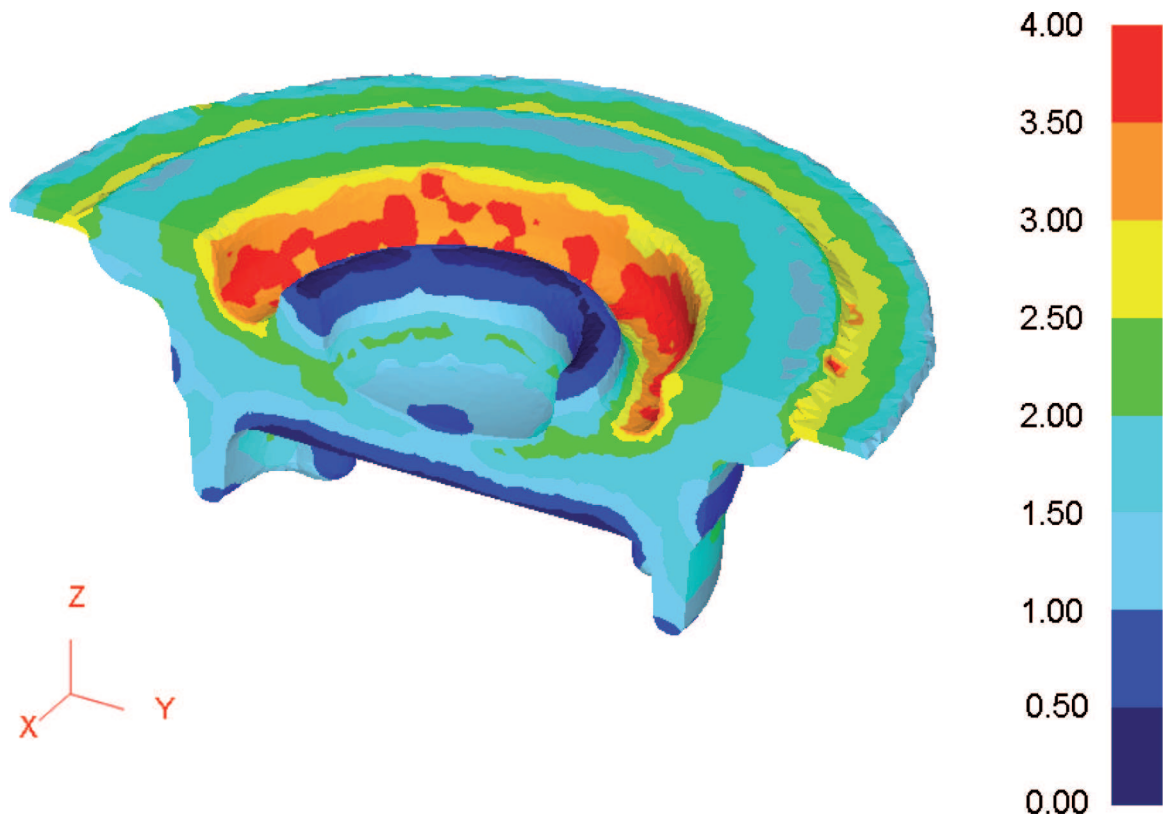

Fig. 3. Strain intensity distribution in a rim forging during hammer forging in initial impression

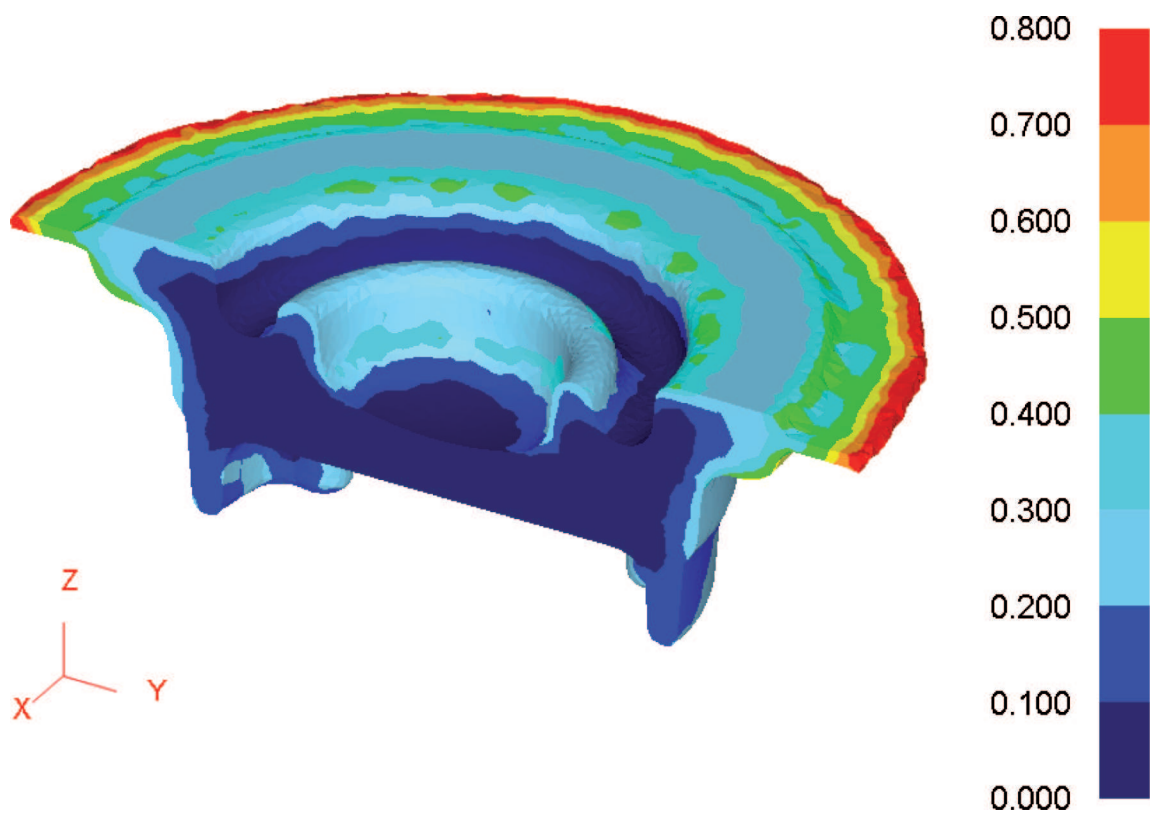

Fig. 4. Distribution of damage criterion (according to Cockcroft-Latham) in a rim forging during hammer forging in initial impression

## 2.2. Forging in die impression

The second operations of forming process is forging in final impression, which takes place after the preform reheating to the temperature 930°C. According to results of conducted numerical simulation, for forming of rim forging two hammer strokes are needed this time. The course of this forging stage together with temperature distribution is illustrated in Fig. 5.

Shorter forming time causes lower discrepancy of the material temperature inside the forging than it was during forging in initial dies. However, it can be seen that the forging layers adhering the bottom die have the temperature considerably lower (of about 300°C) than

the temperature of material layers formed by the upper die. Such a differentiation of temperature can have unfavorable influence on the product final properties.

During forging of the part in final impression, the excessive amount of material is extruded mainly from the bottom areas and ring-shaped flange. This overabundance passes into flash, where the material is intensively crushed and where strains have the largest values (Fig. 6).

Final forging operation is safe due to the possibility of material cracking. Damage criterion assumes small positive values and this happens only in the flash area (Fig. 7).

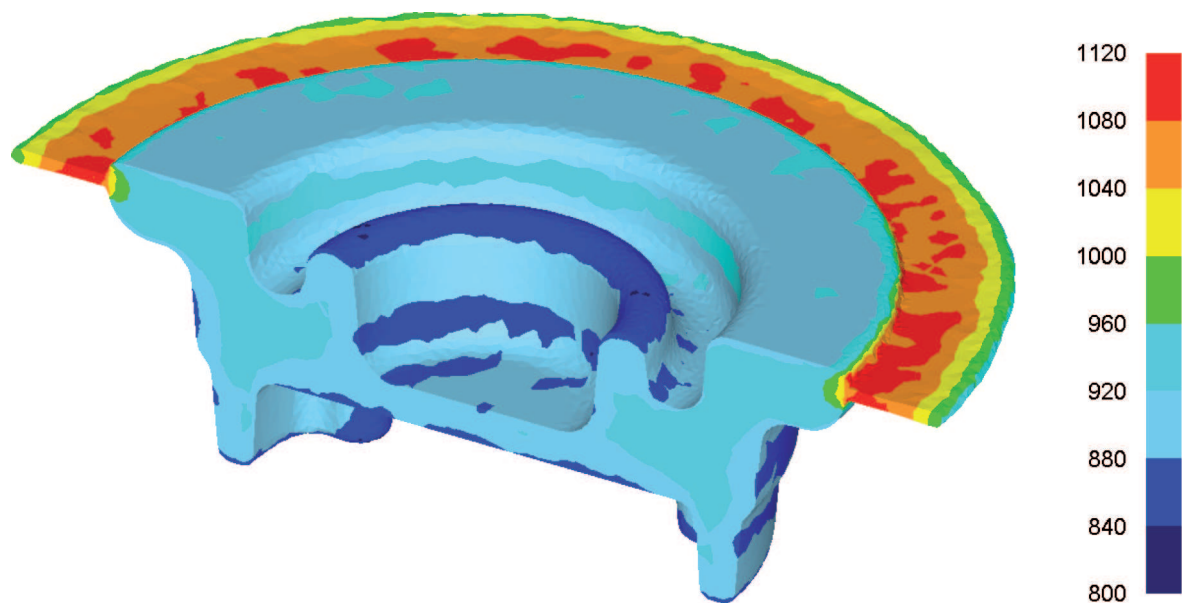

Fig. 5. Temperature distribution in a rim forging (in °C) in the hammer forging process in final impression

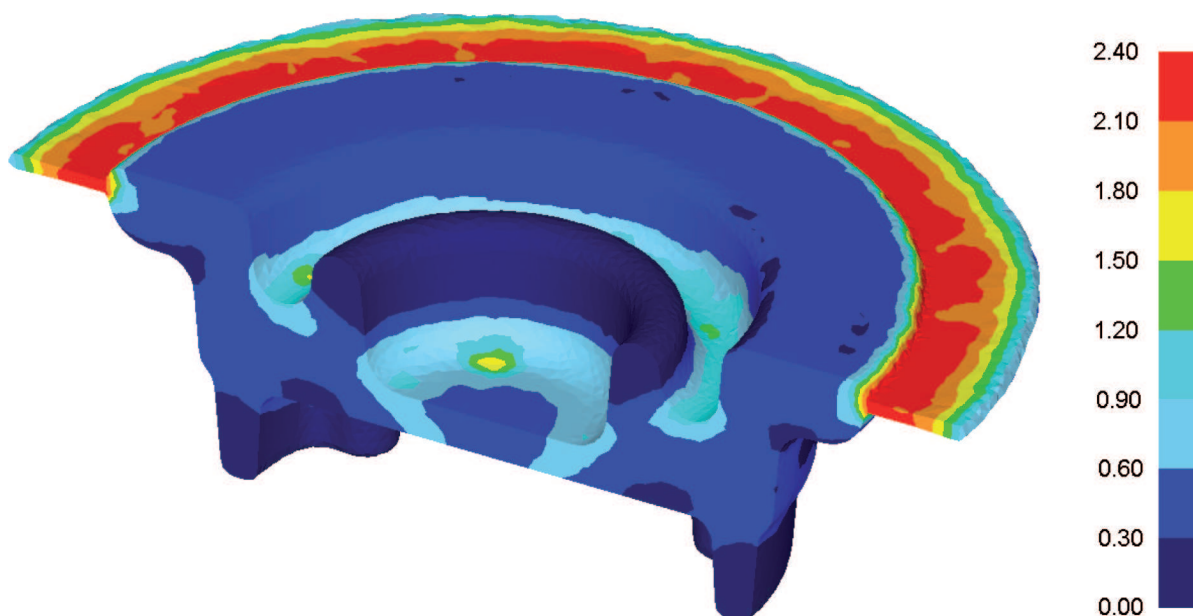

Fig. 6. Distribution of strain intensity in a rim forging in the hammer forging process in final impression



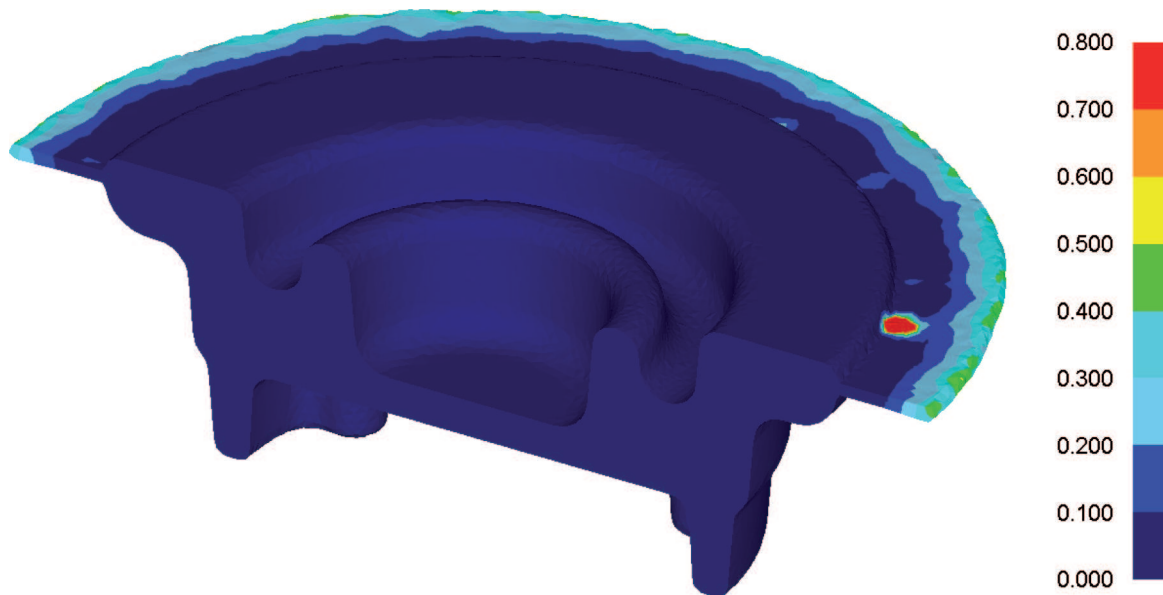

Fig. 7. Distribution of damage criterion (according to Cockroft-Latham) in a rim forging in the hammer forging process in final impression

Forging in final impression requires the application of larger forming forces than in comparison with forging in initial impression. These forces in a very short time, measured in thousandths of a second, reach the values of even 75 MN. Such an unfavorable way of forging dies loading will act, by no means, on lowering their durability.

It should be added that the rim forging forged on hammer has a proper shape, does not have overlapping and shape faults - it reproduces the final die impression well.

### 3. Experimental research

Positive results of numerical simulations provided the basis for conducting experimental verification. After tools constructing, forging tests were made in laboratory conditions of Metal Forming Plant in Świdnik. A steam-air hammer was used of stroke energy 110 kJ and the mass of falling part equal 3000 kg. The billet in the

form of rolls of dimensions  $\emptyset 100 \times 93$  mm was heated in electric resistance furnaces to the temperature  $930^{\circ}\text{C}$ . Heating was realized at two stages, in the first furnace to the temperature  $750^{\circ}\text{C}$ , and next, in the second furnace to the temperature  $930^{\circ}\text{C}$ . Such a way of heating aimed at omitting excessive oxidation. The forging was realized according to the designed technology. Particular stages of the process are given in Fig. 8. The flash was trimmed in hot at the temperature of forging equal about  $800^{\circ}\text{C}$ . After that, the products underwent annealing.

On the basis of obtained experimental results it was stated that forging took place without disturbances. Forgings did not crack. Infilling of the impression as well as overlapping were not observed. An example of forging is presented in Fig. 9. The conducted research works of mechanical properties show that forgings fulfill requirements within this scope, given in technological conditions, i.e.: tensile strength  $TS > 900$  MPa, yield strength  $YS > 830$  MPa, elongation  $EL > 8\%$ , minimal hardness 269 HB.

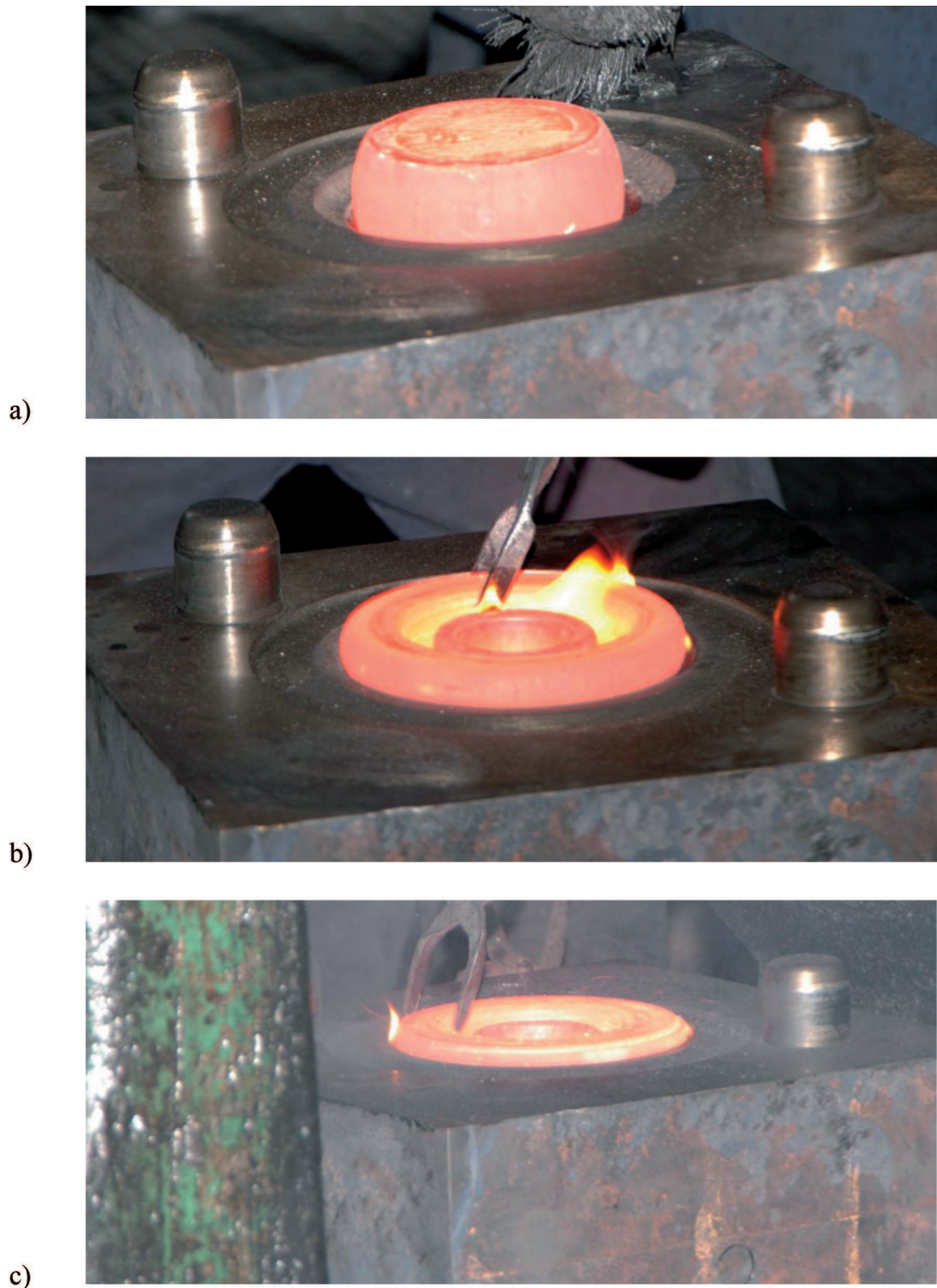

Fig. 8. Stages of the forging process: a) upsetting, b) forging in initial impression, c) forging in final impression



Fig. 9. Finished rim forging

#### 4. Conclusions

The results of theoretical analyses and experimental tests in industrial conditions were accepted as positive.

The worked out technological process and the designed tools allow for forming of rim forgings from titanium alloy Ti6Al4V on hammer. Obtained products are characterized by good quality. They are free from faults

in the form of cracks, overlapping or infilling. Their mechanical properties fulfill requirements determined for the analyzed product.

Theoretical analysis based on numerical simulations allowed for initial verification of the worked out technology correctness. Apart from analysis of parameters distribution in the material such as: temperature, strain intensity or damage criterion, it was possible to make particular improvements, e.g.: the necessity of the billet initial upsetting, which allowed for overlapping elimination in the initial forging operation. On the basis of theoretical analysis, it was also stated that in the forging process large forces appear, which will act on tools fast wear out. In the case of the worked out technology implementation in series production, the possibility of changeable pads, instead of tools which are exposed to the largest surface pressure, should be considered.

#### Acknowledgements

Financial support of Structural Funds in the Operational Programme – Innovative Economy (IE OP) financed from the European Regional Development Fund – Project "Modern material technologies in aerospace industry", No POIG.01.01.02-00-015/08-00 is gratefully acknowledged.

#### REFERENCES

- [1] E. Abele, M. Kreis, M. Weigold, *Werkstatt u. Betrieb* **140**, 66 (2007).
- [2] K.E. Oczóś, *Mech Mies Nauk Tech* **8-9**, 639 (2008).
- [3] F. Djavanroodi, A. Derogar, *Mater Design* **31**, 4866 (2010).
- [4] G. Ambrogio, L. Filice, F. Gagliardi, *Mater Design* **34**, 501 (2012).
- [5] S. Bruschi, S. Poggio, F. Quadrini, M.E. Tata, *Mater Lett* **58**, 3622 (2004).
- [6] J. Sińczak, S. Bednarek, *Przegląd Mechaniczny* **7-8**, 21 (2007).
- [7] K. Shi, D.B. Shan, W.C. Xu, Y. Lu, *J Mater Process Tech* **187-188**, 582 (2007).
- [8] B.P. Bewlay, M.F.X. Gigliotti, C.U. Hardwicke, O.A. Kaibyshev, F.Z. Utyashev, G.A. Salischev, *J Mater Process Tech* **135**, 324 (2003).
- [9] S. Jiang, K. Zhang, *T Nonferr Metal Soc* **19**, 418 (2009) – nadplastyczność.
- [10] A. Gontarz, A. Dziubińska, Ł. Okoń, *Arch Metall Mater* **56**, 379 (2011).