

M. KOROLCZUK-HEJNAK*

DETERMINATION OF FLOW CURVES ON SELECTED STEEL GRADES IN THEIR LIQUID STATE

WYZNACZANIE KRZYWYCH PŁYNIĘCIA WYBRANYCH GATUNKÓW STALI W STANIE CIEKŁYM

Issues of viscosity and rheological properties of liquid ferrous solutions are important from the perspective of modelling, along with the control of actual production processes related to the manufacturing of metals, including iron and steel. Conducted analysis within subject literature indicates that there are many theoretical considerations concerning the effects of viscosity of liquid metal solutions. The objective of this study was to perform rheological measurements of liquid ferrous solutions, the results of which may be used as the basis for developing viscosity models as a function of chemical composition, temperature, and a selected rheological parameter. The study contains the results of rheological tests of ferrous solutions - six chemical compositions with a carbon content from 0.15 to 0.39% and which were tested with applied shear rates from 40 to 180 s⁻¹. The obtained values of dynamic viscosity coefficient are within the range of 0.002 - 0.018 Pa s.

Keywords: viscosity, rheology, liquid steel, rheometer

Zagadnienia lepkości oraz właściwości reologicznych ciekłych roztworów żelaza są ważne z punktu widzenia modelowania, a także sterowania rzeczywistymi procesami technologicznymi w odniesieniu do wytwarzania metali, w tym surowki i stali. Z przeprowadzonej analizy literaturowej wynika, że istnieje wiele teoretycznych rozważań nad zjawiskiem lepkości ciekłych roztworów metali. Celem niniejszej pracy było wykonanie pomiarów reologicznych ciekłych roztworów żelaza, których wyniki mogą stanowić podstawę do opracowania modeli lepkości w funkcji składu chemicznego, temperatury oraz wybranego parametru reologicznego. W pracy zawarto wyniki badań reologicznych roztworów żelaza: sześciu składów chemicznych o zawartości węgla od 0.15 do 0.39% przy zastosowanych prędkościach ścinania od 40 do 180 s⁻¹. Uzyskane wartości współczynnika lepkości dynamicznej są rzędu 0.002-0.018 Pa·s.

1. Introduction

Rheology is a branch of science that has evolved from a branch of physics. Today, however it is an independent area of knowledge that dates back over 70 years. Rheology as a term was used for the first time by Professor E.C. Bingham in 1929: Rheo in Greek means 'to flow'. Rheology deals with research on the responses of real substances to stresses [1]. According to the traditional definition of rheology, it is a science that deals with the deformation and flow of matter, but M. Reiner and S. Blair have proposed a modification of the above definition: "Rheology is the science of the deformation and flow of matter" [2]. In rheological problems we are not interested in the movement of a body as a whole, but movements of some components of this body relative to others. The objective of rheology is either to anticipate the behaviour of the body caused by the force system applied, or to anticipate the force system that causes specific body behaviours [3]. The rheological behaviour of a material is described by relationships between the stresses, strains, strain rates, and the time in which the material has been subjected to a particular strain.

Rheology describes the effects that occur in a very broad area between the solid and liquid states, and therefore it may

be considered a science that deals with the behaviours of real substances which, when subjected to deformation, show more than one basic rheological property – elasticity or viscosity. It is an interdisciplinary science, and therefore the approaches, the types of research methods applied, and how the rheological research findings are utilized, are fairly diversified.

The viscosity effect in metallurgical processes is amongst the most important, influencing the behaviours of reacting phases (metallic, slag and gaseous) with regard to the kinetics of mass exchange or chemical reactions [4, 5]. Viscosity also plays a significant role in all metallurgical processes – ironmaking, steelmaking, ladle refining, steel casting, and processes related to solidification. Viscosity is very important from the standpoint of the flow of liquid phases as they are continuously moving during the aforementioned processes [6]; it is also important due to the internal structure of the metallic or slag phase, along with related possibilities of contamination absorption, or the ability to deform in their semi-solid states [7, 8, 9].

For the purposes of the simulation of metallurgical processes, it is necessary to have access to experimental data. This concerns a broad range of chemical compositions and temperature as regards metal, and also oxide phases such as

* AGH UNIVERSITY OF SCIENCE AND TECHNOLOGY, AL. A. MICKIEWICZA 30, 30-059 KRAKÓW, POLAND

metallurgical slags [10]. Data originating from measurements taken at high-temperature is necessary for the engineering of new processes, and for the optimization of those already in existence – that is, better control of the process, and/or improvement of product quality. Many mathematical models have been created in the past years that can assist in describing thermodynamics, kinetics, fluid flow and heat exchange: obtaining of "good" (correct) data from measurements was the basis for the creation of accurate models [11]. Because of the difficulties related to obtaining access to specialist instrumentation such as high-temperature rheometers – along with the degree of complexity that burdens rheological measurements – very little data [12-16] concerning liquid ferrous solutions can be obtained from subject literature.

2. Research methodology

The rheological tests were conducted with a FRS1600 high-temperature rheometer, presented schematically in Fig. 1.

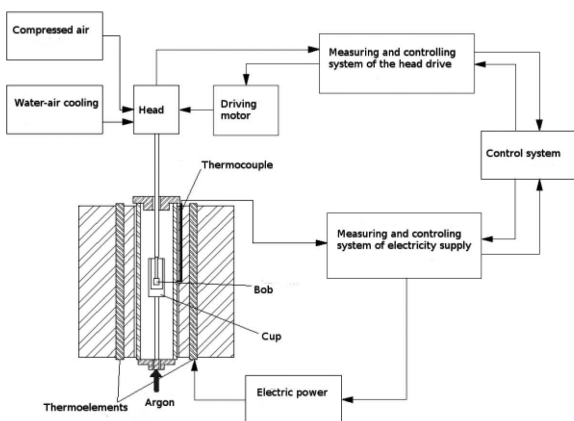

Fig. 1. High temperature rheometer FRS1600

The measurement is performed in a fixed crucible into which a sample of the material tested is placed, then a rotating spindle is immersed within the material being tested. The crucible is then placed inside a ceramic shroud, being a component of a heating furnace. The furnace, which is built of four electrically heated SiC type heating elements, enables the maximum temperature of 1520°C to be obtained within the sample. The whole device is shielded from the outside with an insulating material. The temperature inside the furnace is controlled by a change in feeder power in the measurement and control system. The heating rate, along with maintaining the temperature at a constant level, are set in the control panel of the Rheoplus software of the rheometer. Rotary movements of the spindle are controlled by a motorised measurement head - the spindle being suspended on a ceramic tube placed in an air bearing. In order to ensure low temperatures of the head, it is cooled with water and air.

Ceramic spindles (diameter 26.6 mm) and crucibles (with a smooth inner surface) were used for the tests. Figure 2 presents technical drawings of tools used for the measurements.

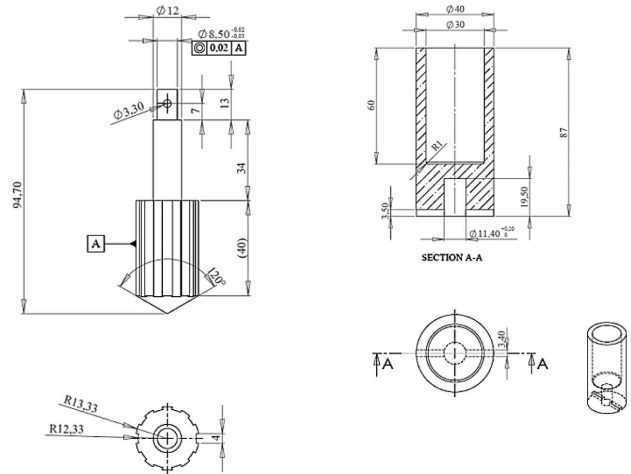

Fig. 2. The geometry of bob and cup used for measurements

In this study, the measurement methodology in a system of coaxial Searle type cylinders was used for conducting high-temperature rheological measurements of steel.

The cylindrical measurement method is based on a system built of an inner cylinder (bob) and an outer cylinder (cup). A schematic diagram of coaxial cylinders is presented in Figure 3.

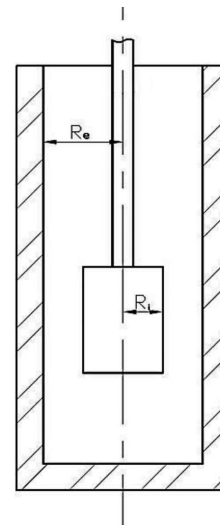

Fig. 3. Concentric cylinder system

Coaxiality means that both cylinders in the working position have a common axis of symmetry (or axis of rotation, respectively). In other words, they can be defined as coaxial cylinders, where:

- R_e – crucible radius,
- R_i – spindle radius.

3. Analysis of Findings

In this study, the following ferrous solutions were examined (Table 1).

For each of the aforesaid grades:

- the Scheil algorithm is representing the non-equilibrium crystallisation,
- the Lever algorithm is representing the equilibrium crystallisation,

- the Back Diffusion is representing the back diffusion model.

TABLE 1

Chemical compositions of analyzed steel grades [%]

Steel grade	C	Mn	Si	Cr	Ni	Mo	V
90CrV6	0,89	0,26	0,19	1,43	0,44	0,06	0,106
34CrNiMo	0,39	0,62	0,24	1,57	1,67	0,26	0,074
DHQ3	0,80	0,26	0,69	2,93	0,13	0,54	0,011
42CrMo4	0,43	0,83	0,23	1,13	0,29	0,28	0,0068
45	0,46	0,74	0,30	0,17	0,24	0,06	0,052

These algorithms were applied to calculate the values of the liquidus and the solidus temperatures [16-17] (Table 2) for the selected steel grades. Thermodynamic databases – CompuTherm LLC – supplied together with the ProCAST software package were used for the calculations. The calculated temperature values are necessary to determine the measurement pattern, assuming that the steel tested is to be in a fully liquid state.

TABLE 2

Liquidus and solidus temperature values calculated for analyzed steel grades [°C]

Steel grade	Liquidus Temperature likwidus	Solidus Temperature solidus
90CrV6	1463	1349
34CrNiMo	1465	1343
DHQ3	1461	1345
42CrMo4	1492	1422
45	1493	1418

Rheological tests were conducted for five steel grades differing with chemical compositions (Table 1). These tests were carried out at liquidus temperatures (Table 2) and at temperatures up to 20 Celsius above and below the calculated liquidus temperatures. Measurements were taken every 10 degrees.

The steel tests were carried out in conditions of variable rheological parameters. Their objective was to find influences of the aforementioned variables on the value of the liquid steel dynamic viscosity coefficient, and thus attempting to determine their rheological nature. During tests conducted at nine various temperatures (at the liquidus temperature and twenty degrees below and above the liquidus temperature calculated for each steel), the shear rate value was changed from 40 to 180 s^{-1} . For each shear rate value – at a given temperature and for a given chemical composition – the measurement taken lasted for a minimum of three minutes, with data readings taken every minute. As a result of these experiments, over 3000 data records were obtained. For legibility purposes, these results were presented in the form of viscosity and flow curves which were then grouped by the temperature at which the tests were performed and their chemical composition.

Figures 4-12 present the flow curves for five steel grades examined at various temperatures. The objective of this

method of result presentation is to picture the differences in tangential stress values (flow curves) between ferrous solutions with various chemical compositions that were tested at the same temperatures.

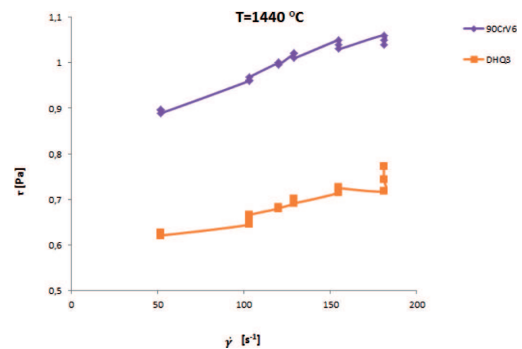

Fig. 4. Flow curves in temperature 1440°C

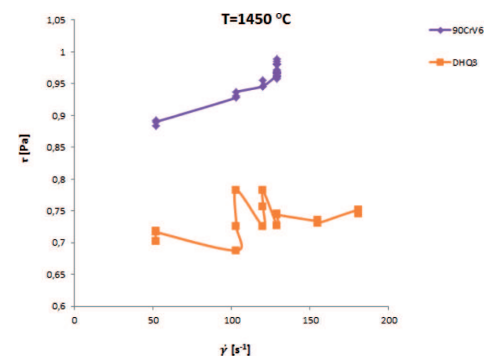

Fig. 5. Flow curves in temperature 1450°C

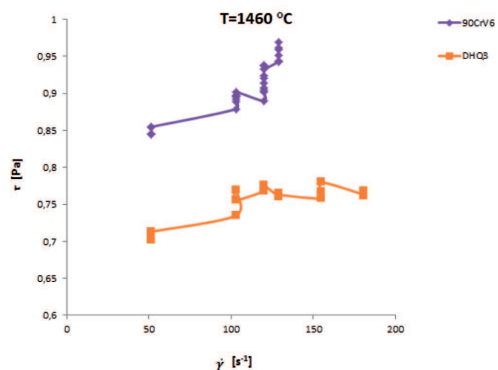

Fig. 6. Flow curves in temperature 1460°C

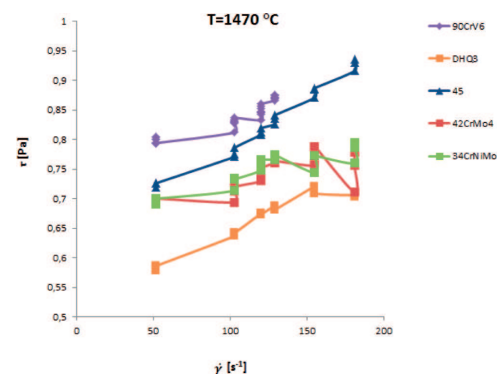

Fig. 7. Flow curves in temperature 1470°C

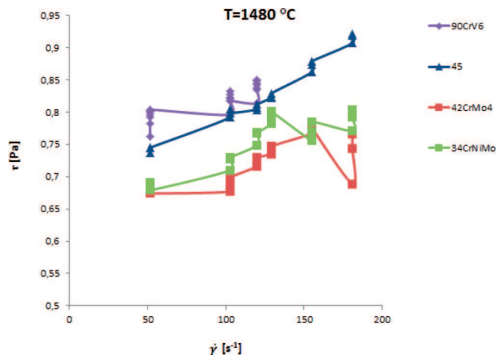

Fig. 8. Flow curves in temperature 1480°C

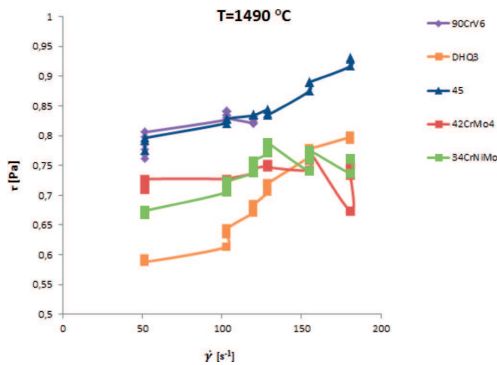

Fig. 9. Flow curves in temperature 1490°C

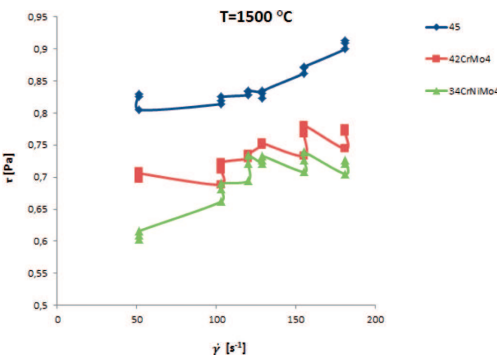

Fig. 10. Flow curves in temperature 1500°C

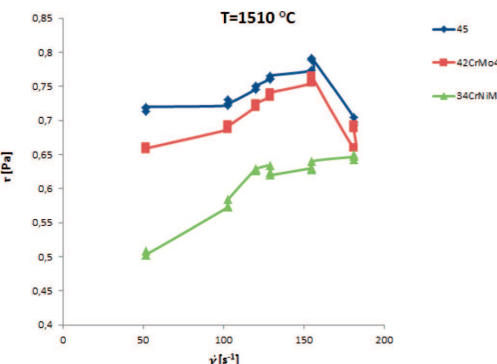

Fig. 11. Flow curves in temperature 1510°C

An analysis of the above graphs (Fig. 4-12) revealed that the tangential stress values range from 1.0 to 0.55 Pa; in addition, at higher temperatures of 1520, 1510, and 1500°C, they are within the range of 0.9-0.6 Pa. At lower temperatures, a small increase in the tangential stress value occurs. At temperatures of 1490, 1480, and 1470°C, the steel flow curves "go in pairs" in terms of Mo content (90CrV6 – 45; 34CrNi-

Mo – 42CrMo4). A decline in the tangential stress value was observed at temperatures of 1520, 1510, and 1500°C when carbon content decreased and chromium content increased, and the silicon content in the alloys was comparable. During analysis of the curves it was also observed that the flow curve for the 45 steel has a slightly different nature than the other; at each temperature this curve, for the highest values of the rotational speed, "climbs up"; whereas the flow curves of the other steels in the same rheological conditions slightly "fall down". The 45 steel is a steel with a fairly high content of manganese and silicon and the lowest chromium content out of the analysed steel grades.

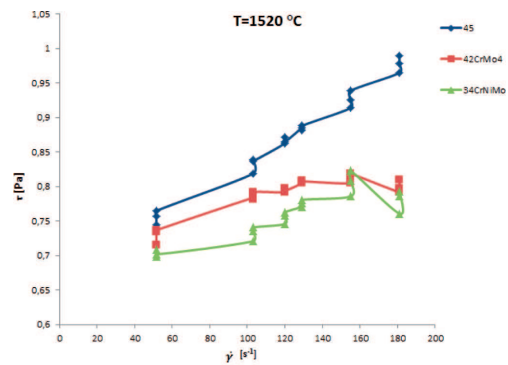

Fig. 12. Flow curves in temperature 1520°C

Figures 13-17 present the flow curves of five steel grades that differ with their chemical compositions. The objective of this presentation of results is to picture the differences between the values of dynamic viscosity coefficient and tangential shear for a given chemical composition at various temperatures.

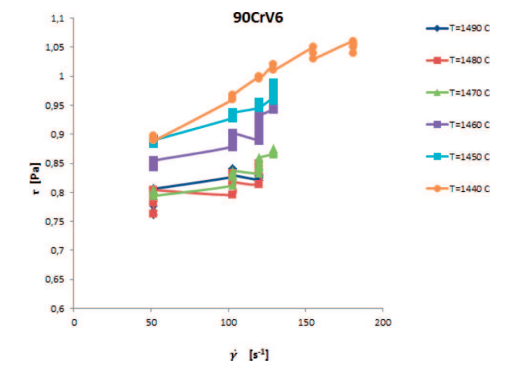

Fig. 13. Flow curves for 90CrV6 steel grade

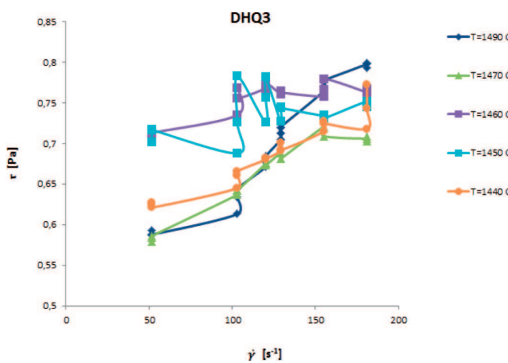

Fig. 14. Flow curves for DHQ3 steel grade

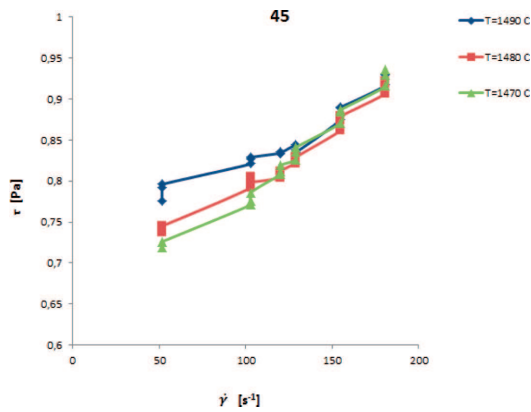

Fig. 15. Flow curves for 45 steel grade

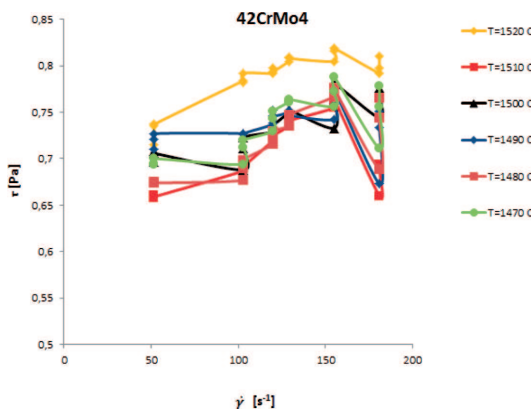

Fig. 16. Flow curves for 42CrMo4 steel grade

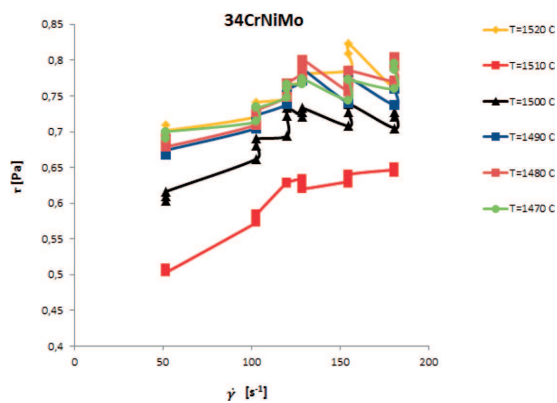

Fig. 17. Flow curves for 34CrNiMo steel grade

Based on the analysis of the above graphs (Fig. 13-17) it was found that the tangential stress values range from 0.9 to 0.4 Pa; for the 90CrV6 steel, from 1.0 to 0.7 Pa. The flow curves of the 34CrNiMo steel are characterised by the biggest differentiation in terms of tangential stress values (the values within the range 0.8-0.45). The flow curves of the 42CrMo4 and 45 steels in which the manganese content is the highest among the tested chemical compositions, are the most comparable to each other. Steels with identical manganese content (0.26%) – 90CrV6 and DHQ3 – feature the same difference between the highest and the lowest values of the tangential stress, although for the 90CrV6 steel this range is 1.0-0.7 Pa, and for DHQ3 it is 0.8-0.5 Pa. The highest carbon content (out of the steels analysed) may be the reason why 90CrV6

has the highest value of the tangential stress (out of the grades tested).

4. Conclusion

The problem of viscosity and rheological properties of liquid ferrous solutions is important from the perspective of modelling, and also control of the actual production processes related to manufacturing of metals, including iron and steel. The conducted analysis of literature indicates that there are many theoretical considerations concerning rheological effects, while experimental results are scarce.

In this study the measurement methodology in a system of coaxial Searle type cylinders was used in order to conduct high-temperature rheological measurements of steel. During preparations for the tests, shapes of measurement tools were designed, and tools made of various ceramic materials were tested. In terms of availability and strength, the optimal material for the measurement systems was selected.

Rheological tests of liquid steel solutions were then carried out, and five various chemical compositions were analysed. During these experiments the solution temperature was step changed every 10°C , from 20°C above the calculated liquidus temperature to 20°C below this temperature. In addition, during measurements the shear rate value was changed from 40 to 180 s^{-1} . During these measurements, the time in which the sample tested was subjected to the same force was also modified. Finally, it was revealed that time was a rheological parameter, and which for measurements of liquid ferrous solutions (in constant process conditions), did not change the rheological nature of the medium examined.

As a result of these conducted experiments the values of liquid steel viscosity coefficient were obtained. These ranged from 0.002 to 0.018 Pa s, and depended on the chemical composition and the applied value of shear rate. In addition, it was found that the tangential shear values declined (1.0-0.9 Pa and 0.7-0.4 Pa) when the carbon content decreased (0.89-0.43%) and the chromium content increased (0.17-2.93%), while the silicon content in the alloys was comparable.

It should be emphasised that on the basis of these conducted tests it is impossible to unambiguously determine the influence of one element on the changes of the liquid steel dynamic viscosity coefficient values. For systems in their fully liquid state (at the theoretical liquidus temperature and above), the conducted rheological analysis allows us to understand that the liquid steel behaves like a Newtonian liquid, albeit with some departures within the tested range of shear rate which may be related – among others – to the occurrence of disturbances to laminar flow in the sample.

Acknowledgements

Financial support of National Science Centre for research project "Developing an empirical model of the rheological properties of liquid metals on the example of iron solutions" no. 2011/01/N/ST8/07368 is gratefully acknowledged. The research was conducted with the financial support from the statutory project no. 11.11.110.225.

REFERENCES

- [1] J. Ferguson, Z. Kembłowski, *Reologia Stosowana Płynów*, Wydawnictwo Marcus, Łódź, 1995.
- [2] M. Reiner, *Reologia Teoretyczna*, Państwowe Wydawnictwo Naukowe, Warszawa, 1958.
- [3] Z. Kembłowski, *Reometria Płynów Nienewtonowskich*, Wydawnictwo Naukowo-Techniczne, Warszawa, 1973.
- [4] M. Karbowniczek, *Pienienie żuźla w procesach stalowniczych*, Uczelniane Wydawnictwo Naukowo-Dydaktyczne, Kraków, 1998.
- [5] P. Migas, M. Karbowniczek, Interactions Between Liquid Slag And Graphite During The Reduction Of Metallic Oxides, *Archives Of Metallurgy And Materials* **55**, 4, 1147-1157.
- [6] K. Sołek, M. Korolczuk-Hejnak, W. Ślęzak, Viscosity Measurements For Modeling Of Continuous Steel Casting, *Archives Of Metallurgy And Materials* **57**, 1, 325-333.
- [7] K. Sołek, M. Korolczuk-Hejnak, M. Karbowniczek, An Analysis Of Steel Viscosity In The Solidification Temperature Range, *Archives Of Metallurgy And Materials* **56**, 3, 593-598.
- [8] Ł. Rogal, J. Dutkiewicz, Effect Of Annealing On Microstructure, Phase Composition And Mechanical Properties Of Thixo-Cast 100cr6 Steel. *Materials Characterization* **68**, 123-130.
- [9] Ł. Rogal and others, Characteristics Of 100cr6 Bearing Steel After Thixoforming Process Performed With Prototype, *China Transactions of Nonferrous Metals Society of China* **20**, 1033-1037 (2010).
- [10] D. Sichen, J. Bygdien, S. Seetharaman, A Model For Estimation Of Viscosities Of Complex Metallic And Ionic Melts. *Metallurgical And Materials Transactions B* **25b**, 519-525 (1994).
- [11] M. Korolczuk-Hejnak, Empiric Formulas for Dynamic Viscosity of Liquid Steel Based on Rheometric Measurements, *High Temperature* **52**, 5, 667-674 (2014).
- [12] G. Hirt, R. Kopp, Redaktorzy: Thixoforming. Semi-Solid Metal Processing. WILEY-VCH GMBH AND CO. KGAA, Weinheim, 2009.
- [13] M. Modigell, L. Pape, H.R. Maier, Rheology Of Semi-Solid Steel Alloys At Temperatures Up To 1500°C, *Solid State Phenomena* **116-117**, 606-609 (2006).
- [14] M. Korolczuk-Hejnak, P. Migas, Analysis Of Selected Liquid Steel. *Archives Of Metallurgy And Materials* **57**, 4, 963-969.
- [15] M. Korolczuk-Hejnak, P. Migas, Selected Grades Of Steel As Rheologically Defined Liquid Bodies, *Archives Of Metallurgy and Materials* **57**, 2, 583-591.
- [16] K. Miłkowska-Piszczyk, M. Korolczuk-Hejnak, An Analysis Of The Influence Of Viscosity On The Numerical Simulation Of Temperature Distribution, As Demonstrated By The CC Process, *Archives Of Metallurgy And Materials* **59**, 4.
- [17] M. Rywotycki, K. Miłkowska-Piszczyk, L. Trębacz, Identification Of The Boundary Conditions In The Continuous Casting Of Steel. *Archives Of Metallurgy And Materials* **57**, 1, 385-393.