

OPTIMIZATION OF STEEL FLOW IN THE TUNDISH BY MODIFYING ITS WORKING AREA

Presented paper describes model investigations carried out on six-strand continuous casting tundish. Numerical analysis is based on simulations performed with the use of commercial code ANSYS Fluent. The analysis concerns determination of hydrodynamic conditions of the flow in the analysed tundish, with nominal capacity of 22 Mg, and its optimisation by modification of the flow structure in the tundish working area. Four different flow control devices (FCD) were proposed.

Results of investigations presented in the paper include the distribution of velocity vectors and distribution of temperature and turbulence kinetic energy. Additionally, for more detailed comparative analysis, the macroscopic characteristics of residence time distribution (RTD) in the reactor, and the transition zone ranges were determined for each of the variants.

Keywords: tundish, continuous casting, numerical modelling

1. Introduction

Continuous casting - compared to the common method of casting into a mould - is a technology, which allows to increase the efficiency of production and metallurgical quality (purity) of the produced steel. Another important factor in the process of continuous casting is a tundish, where the ferrostatic pressure of steel is being decreased and also the bath is being spread into desired number of casting strands. Furthermore, in the tundish take place final metallurgical processes, just before the steel solidification process is being started in the continuous casting mould. Adequate performance of the process affects the quality of moulds being produced under continuous casting. Among processes of significant meaning, which directly affect the efficiency of metallurgical operations performed in the tundish are flow and oscillation of the metal bath.

Direct experimental investigations of the flow field and also on the oscillation of steel material is very difficult to be performed in real conditions and in some cases it is even impossible to be carried out. This is caused, inter alia, by high temperatures of the conducted technological process and nontransparency of the metal bath and the casting machine alone. Therefore, in order to conduct the research study on the flow fields and also on the parameters to set the mould oscillation rate, there are applied determined laboratory and mathematical models, which constitute the basis for numerical modelling. [1–3].

Proper selection of mathematical model, together with appropriately set initial and boundary conditions, can model the phenomena occurring in actual metallurgical reactor. This allows to carry out extensive research study in order to explain accompanying phenomena to the flow of liquid steel in various tundishes during the casting process. However, it should be noted that it is necessary to perform verification of numerical

simulation results with experimental results being conducted on a real industrial unit or at least on physical water models. Majority of numerical simulations on fluid dynamics (CFD - Computational Fluid Dynamics) in the field of continuous casting are being performed by using commercial codes, such as ANSYS Fluent or Phoenix.

The ongoing research studies are related to various aspects of the steel casting technology, including flow, changes in flow conditions, flow control devices (FCD), residence time distribution, heat transfer, distribution and transportation, as well as, the outflow of non-metallic inclusions in the bath of molten metal [4-9]. Qualitative and quantitative assessment of the flow and oscillation of steel in the tundish is being performed based on the analysis of a set of characteristics. Among the most important factors are: theoretical and actual average residence time period in the tundish, residence time distribution (RTD) curves and derived from the curves volumetric (shares of) zones of various kinds of flows in the tundish [10, 11]. The RTD-based characteristics provide insightful information about phenomena occurring in the tundish and furthermore, they are used to verify (industrial, laboratory and numerical) research tests.

Results of model research tests presented in this study relate to changes in the structure of flow in the operational area, being caused by changes in the flow switch in a tundish of the continuous casting machine with six sub-entry nozzles (SEs). Numerical analysis was based on the results of simulations performed by using the ANSYS Fluent commercial code. The research results include distribution of the velocity vectors and field distributions of: temperature and turbulence kinetic energy. Furthermore, macroscopic characteristics of the residence time in the reactor (F-type characteristics of the RTD) were determined and transition zone ranges for particular flow inhibitor were designated.

* CZESTOCHOWA UNIVERSITY OF TECHNOLOGY, DEPARTMENT OF METALS EXTRACTION AND RECIRCULATION, 19 ARMII KRAJOWEJ AV., 42-201 CZESTOCHOWA, POLAND

** SILESIA UNIVERSITY OF TECHNOLOGY, INSTITUTE OF METALS TECHNOLOGY, 8 KRASINSKIEGO STR., 40-019 KATOWICE, POLAND

Corresponding author: warzecha@wip.pcz.pl

2. Object of the research study

Object of the numerical analysis was a tundish with six sub-entry nozzles (SENs) having the capacity of 22Mg. Figure 1 demonstrates characteristic dimensions of the bottom and top surfaces in the analysed tundish. Distribution of stopper rods corresponds to the distribution of submerged entry nozzles in the tundish.

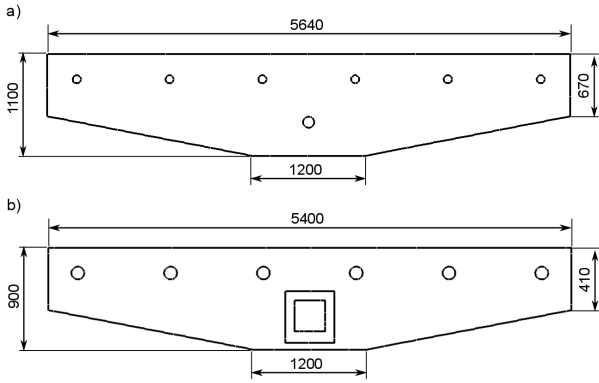

Fig. 1. Dimensions of investigated tundish: top view (a) and bottom view (b)

At the bottom of the tundish is placed a flow inhibitor of working area. There were analysed four types of flow inhibitors, which have been shown schematically in Figure 2. The tundish being the subject of this research study is equipped with a system of stopper rods.

Figure 3 illustrates a scheme of the tundish with marked characteristic areas for which the boundary and initial conditions are being defined. Boundary conditions being applied in the ANSYS Fluent software at the inlet (shroud) to the computational domain - „velocity inlet”, at the outlet (sub-entry nozzle) - „outflow”, top surface - „symmetry”, while other surfaces are described by the boundary condition - „wall”, where adequate rate (flows) of heat removal is being assigned. The „velocity inlet” boundary condition allows for applying -at the inlet to the computational area - a uniform velocity field. The „outflow” boundary condition enables modelling homogeneous outflows in such cases, where neither the flow rate nor pressure are specified. By employing the „symmetry” boundary conditions, it ensures zero-value of basic parameters of the boundary layer, for instance, of y^+ parameter or tangential stresses.

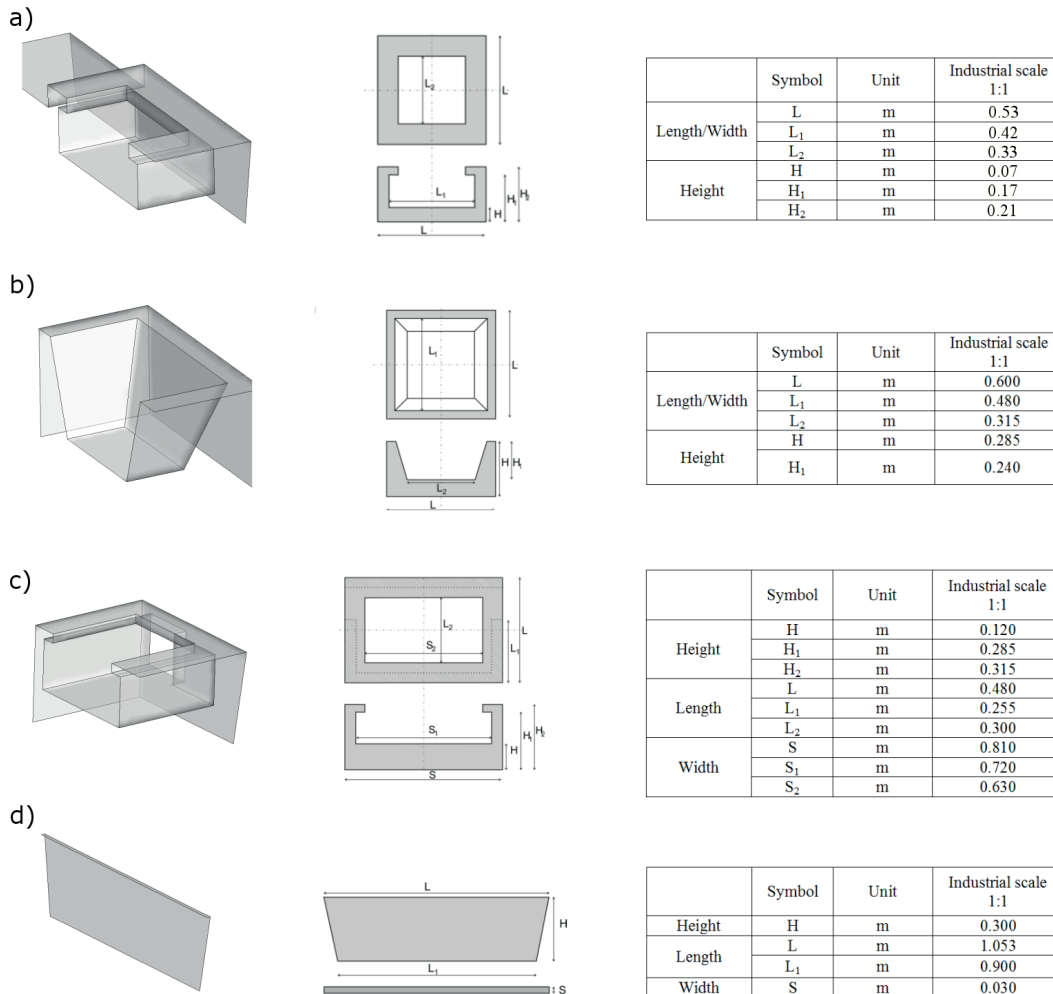

Fig. 2. Dimensions of the flow inhibitors installed in investigated tundish: variant A (a); variant C (b); variant E (c) and variant F (d)

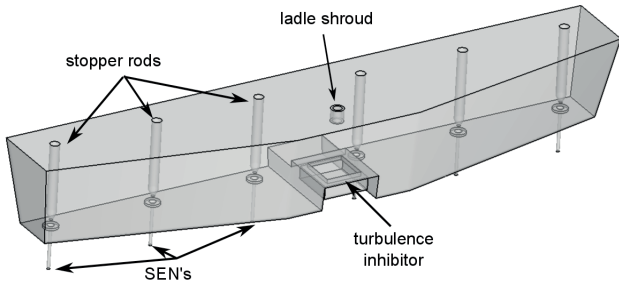

Fig. 3. Schematic view of investigated tundish

As the initial conditions there were adopted actual conditions derived on the test object, namely the casting speed of steel at the inlet and heat streams being removed by particular walls of the tundish. In the analysed tundish, for the surface representing the exit from the computational domain (top surface) was applied a stream of air to remove the heat equal to 15 kW/m², while for the other walls, the assigned flow of heat removal was 2.6 kW/m². There was analysed a test case for which the velocity of molten steel being tapped into the inlet to the computational domain was 1.1 m/s.

3. Results and discussion

The CFD-based research tests were performed to assess the nature of the flow of liquid steel in a tundish being employed in the steelworks.

Turbulence inhibitor (variants A and C, with directional holes) was installed centrally under the stream flowing into the tundish. Whereas, the arrangement of the body of flow control devices for E and F embodiments is shown in Figure 4.

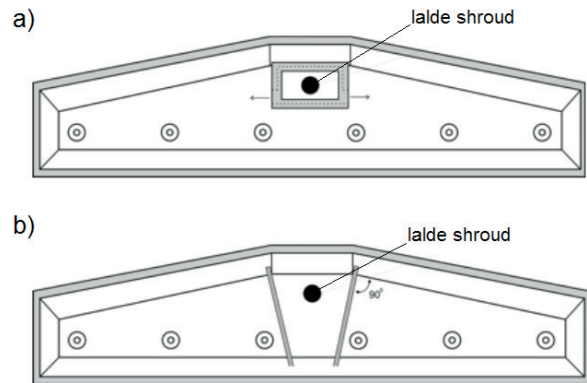

Fig. 4. Location of turbulence inhibitors installed in investigated tundish for variant E (a) and variant F (b)

Numerical analysis of liquid steel flow and oscillation in tundish of continuous casting device was performed for casting speed of 1.9 m/min (CFD flow at the shroud of 1.1 m/s), which corresponds to the average casting speed for cold heading and cold extrusion of steel.

In order to obtain proper transparency in comparing the presented results, the object was divided by two distinctive

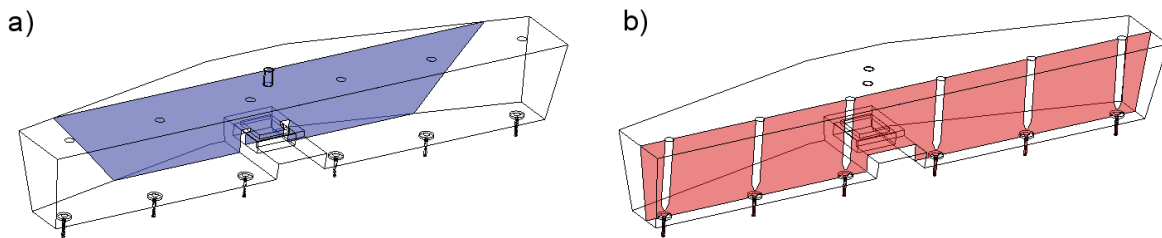

Fig. 5. Location of cross-section A (a) and cross-section B (b) inside investigated tundish

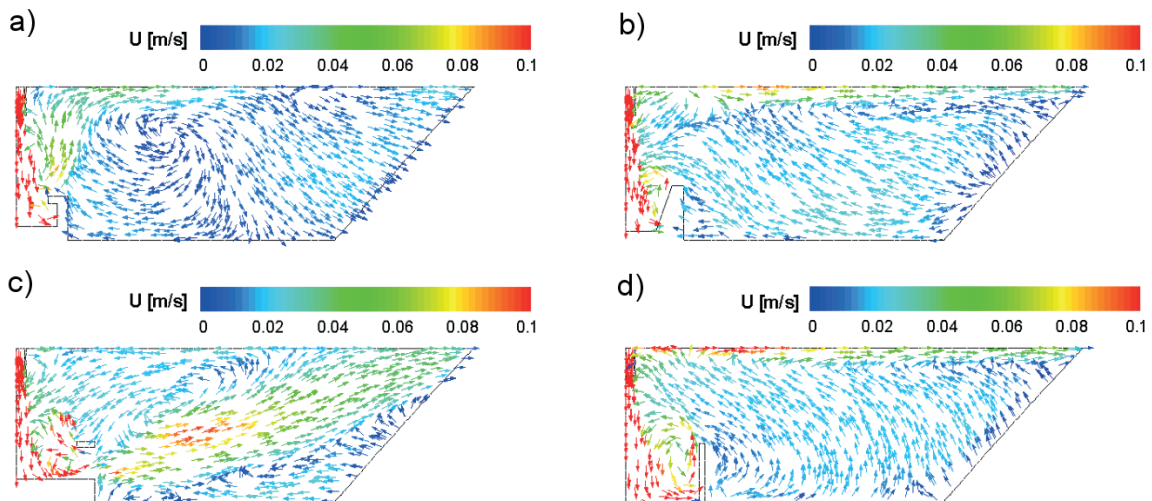

Fig. 6. Velocity vectors presented on cross-section A for variant A (a); variant C (b); variant E (c) and variant F (d)

planes (Figure 5). The first one – vertical – passes through shrouds of the tundish (plane A), while the other one – also vertical, goes through sub-entry nozzles (SENs) of the tundish (plane B). To obtain symmetry of the system (tundish), the analysed results are presented explicitly for half of the object (sub-entry nozzles No.: 1, 2 and 3).

The expected flow of steel in the tundish for four arrangements of the installation on the predefined control planes are presented in Figures 6 and 7.

The state of steel dynamics in the test tundish can be extended with characteristics of turbulent flow. Spatial distributions of turbulence kinetic energy (k) of liquid steel

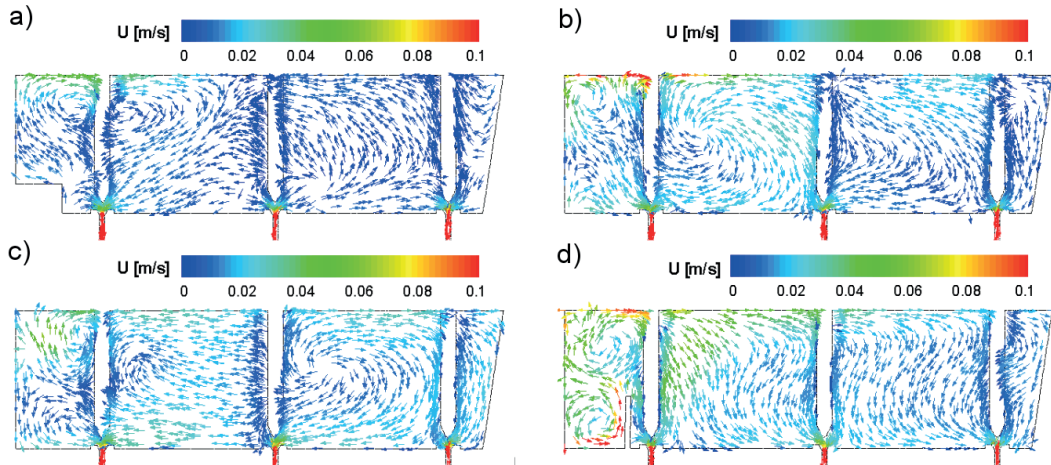

Fig. 7. Velocity vectors presented on cross-section B for variant A (a); variant C (b); variant E (c) and variant F (d)

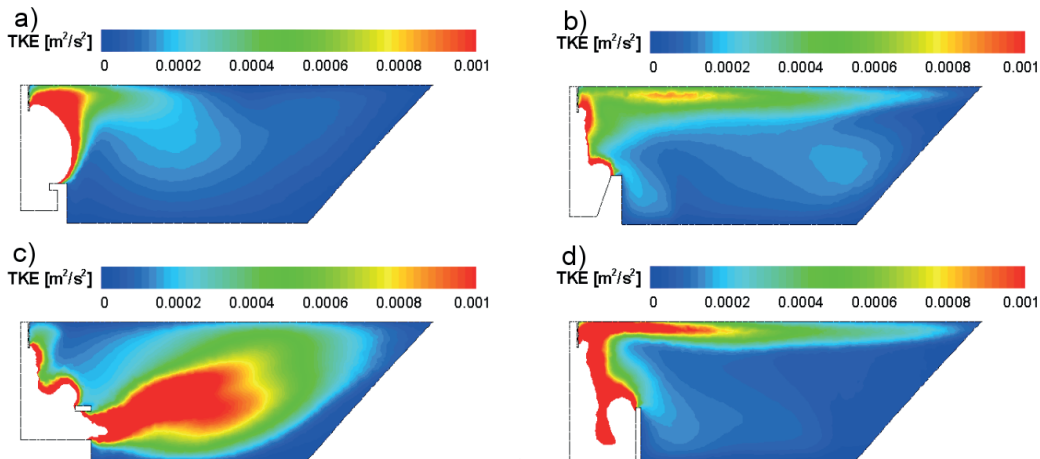

Fig. 8. Contour maps of turbulence kinetic energy presented on cross-section A for variant A (a); variant C (b); variant E (c) and variant F (d)

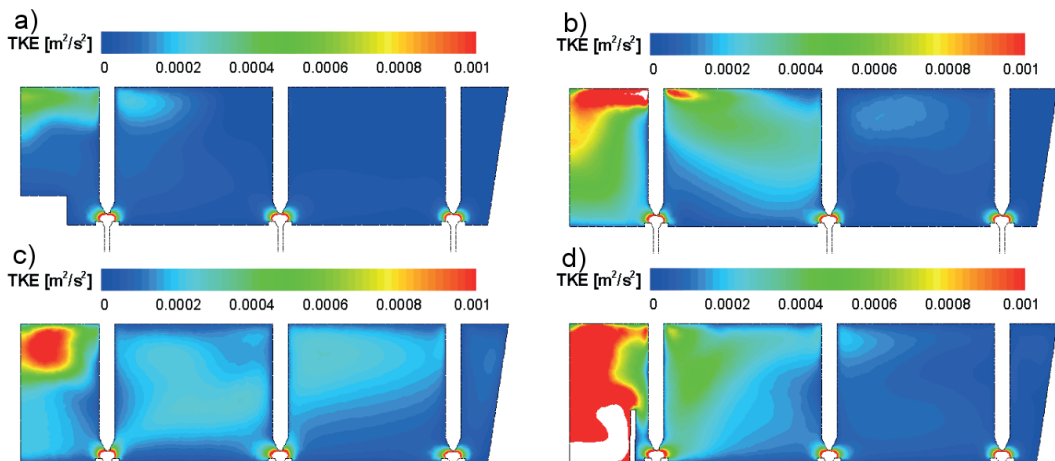

Fig. 9. Contour maps of turbulence kinetic energy presented on cross-section B for variant A (a); variant C (b); variant E (c) and variant F (d)

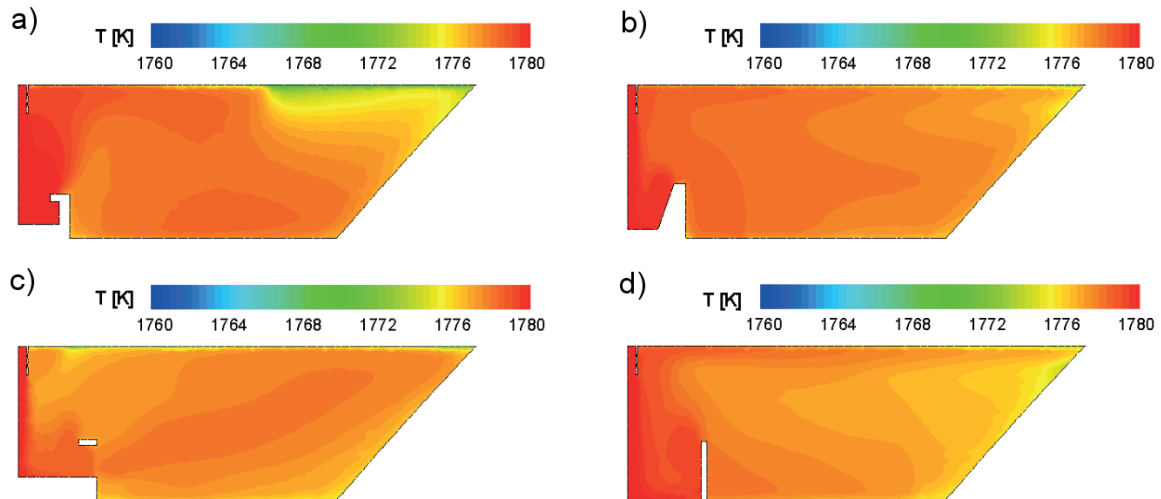

Fig. 10. Contour maps of temperature presented on cross-section A for variant A (a); variant C (b); variant E (c) and variant F (d)

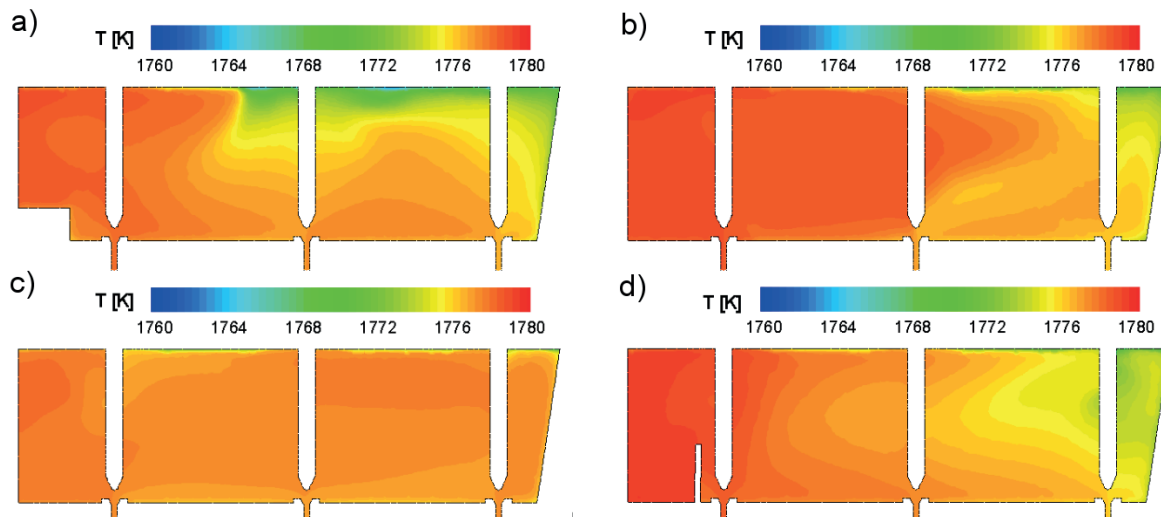

Fig. 11. Contour maps of temperature presented on cross-section B for variant A (a); variant C (b); variant E (c) and variant F (d)

for four arrangements of the installation of the tundish are demonstrated in Figures 8 and 9.

The predicted temperature distribution of liquid steel inner the tundish designed for four arrangements of the installation at control layers are shown in Figures 10 and 11.

The three-dimensional distributions of velocity vectors of steel, as well as the fields of: temperature and turbulence kinetic energy in the tundish operational area are the source of significant knowledge about the conditions of steel casting. However, the distributions do not answer directly the problem, whether the state of steel flows in the tundish is suitable, for example, for mixing processes (sequential casting of different steel grades) or for removal of non-metallic inclusions. Firm answers on these problems are being obtained by means of macroscopic RTD characteristics, which belong to the field of research studies on flow reactors.

Dimensionless RTD characteristics of F-type curve for the analysed arrangement of the installation are shown in Figure 12.

Values of the dimensionless concentration of the tracer were derived directly from the CFD analysis. While the dimensionless time was computed based on the expression:

$$\dot{E} = t_r / \tau \quad (1)$$

where:

$$\tau = V / Q_v \quad (2)$$

For tested variants $\tau = 675$ s.

The presented characteristics are commonly used to assess the conditions occurring in the tundish. By analysing the Figure 12, the transition zone can be assessed by determining its range (ΔT), being determined on the basis of the difference in times needed to achieve concentrations at levels of 20 and 80 % of the concentration predicted for a given grade of steel. By adopting the value of 0 - on the ordinate axis of the presented curve as the current grade of steel being casted - and the value of 1 - as the next grade, the value of the range of the transition

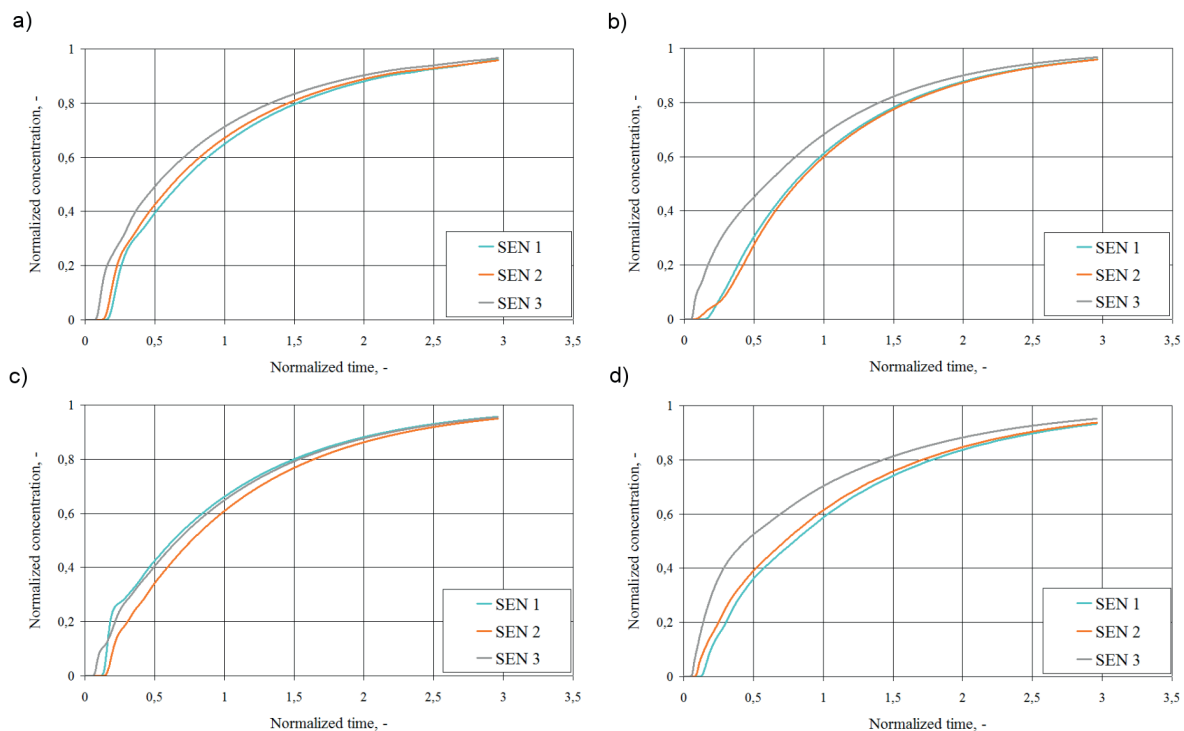

Fig. 12. RTD characteristics (Type F curve) for investigated tundish with turbulence inhibitor: variant A (a); variant C (b); variant E (c) and variant F (d)

zone (namely, the range between 0.2÷0.8 of the dimensionless concentration) can be determined. The designated values of the dimensionless time of the transition zone and needed to reach by the tracer the particular sub-entry nozzles are contained in Table 1.

TABLE 1
The range of the transition zone for the tested variants

Turbulence inhibitor	Transition zone [-]			
	SEN 1	SEN 2	SEN 3	mean value for SEN's
variant A	1,28	1,25	1,19	1,24
variant C	1,19	1,18	1,23	1,20
variant E	1,32	1,34	1,32	1,33
variant F	1,48	1,46	1,29	1,41

4. Summary and conclusions

In order to obtain credible interpretation of the numerical analysis results, at the initial stage of the study the model should be verified. Preliminary verification of the numerical model was performed at pre-stage of the research study by using the measurements recorded on the water model. This allows the author to conclude that the numerical model describing the flow and mixing of steel in the tundish was properly formulated and verified.

As in the case of experimental analysis, also the performed numerical simulations confirm that each of the presented arrangements of the installation of operational area in the tundish can be applied in industrial conditions. However, in the

contrary to the laboratory tests, the numerical model enables in-depth analysis of the structure of steel flow and temperature distribution in the operational area of the tundish. On this basis, more accurate conclusions can be drawn on the ability of increasing the capabilities for refining the impurities, in order to eliminated non-metallic inclusions, which is of crucial meaning for the production process of steel with required very high purity and to ensure the degree of homogenization of steel poured into moulds in terms of chemical and temperature aspects.

Acknowledgements

Acknowledgements to the National Centre for Research and Development for financial support (project No PBS2/A5/32/2013).

Nomenclature

- θ dimensionless time
- τ theoretical, mean resident time
- t_r real time
- V volume
- Q_v volumetric flow rate

REFERENCES

- [1] K. Chattopadhyay, M. Isac, R. I. L. Guthrie, *ISIJ Int.* **51**, 573–580 (2011).
- [2] K. Chattopadhyay, M. Isac, R. I. L. Guthrie, *ISIJ Int.* **52**, 2026–2035 (2012).
- [3] K. Takahashi, M. Ando, T. Ishii, *ISIJ Int.* **54**, 304–310 (2014).

- [4] D. Chen, X. Xie, M. Long, M. Zhang, L. Zhang, Q. Liao, *Metall. Mater. Trans. B* **45**, 392-398 (2014).
- [5] Q. Wang, F. Qi, B. Li, F. Tsukihashi, *ISIJ Int.* **54**, 2796–2805 (2014).
- [6] S. Chang, L. Zhong, Z. Zou, *ISIJ Int.* **55**, 837–844 (2015).
- [7] H. Cui, Y. Liu, D. Li, *ISIJ Int.* **55**, 2604–2608 (2015).
- [8] A. Cwudziński, *Steel Res. Int.* **85**, 902-917 (2014).
- [9] A. Tripathi, A. Kumar, S. K. Ajmani, J. B. Singh, V. V. Mahashabde, *Steel Res. Int.* **86**, 1558–1573 (2015).
- [10] C. Chen, G. Cheng, H. Sun, Z. Hou, X. Wang, J. Zhang, *Steel Res. Int.* **83**, 1141–1151 (2012).
- [11] H. Lei, *Metall. Mater. Trans. B* **46**, 2408-2413 (2015).

