

R. PASTIRČÁK*, J. ŠČURY*, M. BRŮNA*, D. BOLIBRUCHOVÁ*, J. JAKUBSKI**

INFLUENCE OF CASTING WALL THICKNESS ON CRYSTALLISATION UNDER PRESSURE

The paper deals with squeeze casting technology. For this research a direct squeeze casting method has been chosen. The influence of process parameters variation (casting temperature, mold temperature, pressure) on mechanical properties and structure will be observed. The thicknesses of the individual walls were selected based on the use of preferred numbers and series of preferred numbers (STN ISO 17) with the sequence of 3.15, 4.00, 5.00, 6.00 and 8.00 mm. The width of each wall was 22 mm with a length of 100 mm. As an experimental material was chosen the AlSi12 and AlSi7Mg0.3 alloys. The mechanical properties (UTS, E) for individual casting parameters and their individual areas of different thicknesses were evaluated. In the structure the influence of pressure on the change of the eutectic morphology, the change of the volume of eutectic and the primary alpha phase, the effect of the pressure on the more fine-grain and the regularization of the structure were evaluated.

Keywords: Squeeze casting, AlSi7Mg0.3 alloy, AlSi12 alloy, pressure, wall thickness

1. Introduction

The squeeze casting technology is a relatively unusual method. This is due, in particular, to little experience with practical use combined with the low lifetime of the mold, which is caused by high thermal and mechanical stresses combined with a long cycle time. With direct squeeze casting, the cycle time can be up to about 1 minute. Such stress greatly reduces the life of the mold [1,3,9,10]. The main characteristics of this method, which are distinguishing it from conventional high-pressure casting include, in particular, the slow filling of the melt into the mold cavity (roughly $0.5 \text{ m}^3\text{s}^{-1}$) and considerably larger gates, than those used in the high-pressure casting. The slow filling of the mold cavity guarantees a laminar flow without turbulences. In addition, a longer filling time allows evacuation of gases from the mold cavity, which reduces the resulting porosity of the casting. Thanks to the large slit, the melt and later the casting itself are constantly under the influence of the applied pressure, while the gates solidified as last. This allows continuous melt substitution in interdendritic areas. The result of this is high integrity and minimum casting porosity. This also prevents the creation of various foundry defects. These castings shows high mechanical properties, which can be further increased by subsequent heat treatment [2,4,5,8]. The pressure at squeeze casting is from 30 to 150 MPa, depending on the type of alloy used, the casting temperature, and more. The pressure itself prevents the formation of an air gap, which is normally formed at the gravity casting between the casting and the mold. This air gap substantially

slows heat transfer and thus also the cooling rate of the casting. By eliminating the gap due to pressure, there are significant changes in the structure and also in the mechanical properties of the material. The structure, the grains size of the primary structure is reduces and also is change the morphology of eutectic silicon and intermetallic phases, which act less harmful. The resulting structure is finer and more uniform throughout the volume. The concentration of silicon in the eutectic and the volume ratio of the primary α -phase is increased and the volume of the eutectic in the structure is reduced. The result is a change in mechanical properties, where the strength, elongation and fracture toughness are increasing. At the gravity casting achieves a better mechanical properties the parts of casting, which solidified faster, in this case is about the thinnest parts of the casting. Pressure utilization at the squeeze casting technology greatly accelerates solidification and cooling in the thicker areas of the casting. This is associated with eliminate of an air gap formed by gravity casting. The result is a change in structure and a significant increase in mechanical properties compared to gravity casting [1,4,6,7].

2. Experiment methodology

The aim of the experiment was to verify the effect of change of the casting walls thickness on the mechanical properties and structure of the aluminium alloys under the influence of a low pressure during solidification of the casting. For this research a direct squeeze casting method has been chosen. For the study of

* UNIVERSITY OF ŽILINA, FACULTY OF MECHANICAL ENGINEERING, DEPARTMENT OF TECHNOLOGICAL ENGINEERING, ŽILINA, SLOVAKIA

** AGH UNIVERSITY OF SCIENCE AND TECHNOLOGY, FACULTY OF FOUNDRY ENGINEERING, REYMONTA 23 STR., 30-059 KRAKOW, POLAND

Corresponding author: Richard.Pastircak@fstroj.uniza.sk

crystallisation under pressure, a casting with different thickness of the walls was used, which is shown in Fig. 1. The thicknesses of the individual walls were selected based on the use of preferred numbers and series of preferred numbers (STN ISO 17) with the sequence of 3.15, 4.00, 5.00, 6.30 and 8.00 mm. The width of each wall was 22 mm with a length of 100 mm. Dimensions were chosen to evaluate the mechanical properties of individual casting walls (UTS, E).

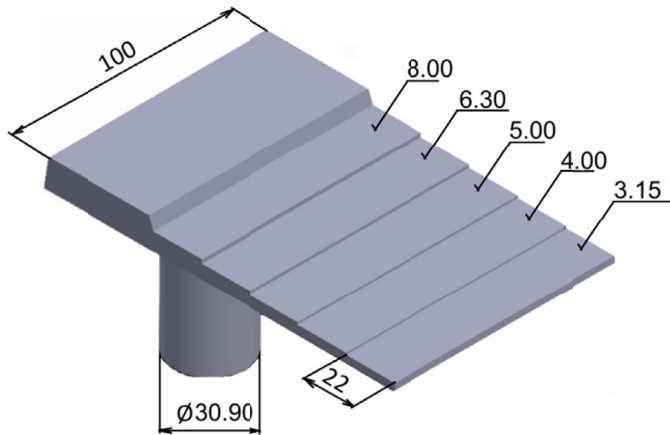

Fig. 1. Casting model

As an experimental material was chosen the AlSi12 (EN AC 44100) and AlSi7Mg0.3 alloys (EN AC 42100), which chemical composition is shown in Table 1 and Table 2. They are an eutectic and hypoeutectic alloys, whose strength in condition after casting into the mold are approximately the same and is about 170-180 MPa.

TABLE 1

Chemical composition of the AlSi12 alloy

Chemical composition [wt. %]							
Fe	Si	Mn	Ti	Cu	Mg	Zn	AL
0.27	11.96	0.038	0.061	0.075	0.053	0.012	rest

TABLE 2

Chemical composition of the AlSi7Mg0.3 alloy

Chemical composition [wt. %]							
Fe	Si	Mn	Ti	Cu	Mg	Zn	Al
0.074	7.6	0.002	0.0034	0.002	0.348	0.0042	rest

For the experiment, a low carbon steel mold was made. It was composed of two parts. The bottom fixed part of the mold copied the shape of the step casting. In the upper movable part of the mold, the inlet system was adapted to apply pressure. The piston diameter was 30.9 mm with a 750 mm² area.

During the experiment, several technological parameters were varied like casting temperature, mold temperature and pressure. The pressure applied for the AlSi7Mg0.3 alloy was 30 MPa and for the AlSi12 alloy was 50 MPa. Various pressures have been chosen due to various morphologies of solidification

of the alloys used. For AlSi12 alloy, it is necessary to overcome the greater resistance caused by immediate solidification after filling the mold. The acting pressure was applied for 2 seconds after the mold was filled. The casting temperature was differed with respect to the alloy used. The lowest casting temperature, when the melt completely filled the mold was about 730°C for AlSi7Mg0.3 alloy. The used technological parameters are shown in Table 3.

TABLE 3

Casting parameters of individual samples

Alloy	Number casting	Mold temperature [°C]	Pouring temperature [°C]	Pressure [MPa]
AlSi7Mg0.3	Casting 7/0	250	730	0.1
	Casting 7/1	250	730	30
	Casting 7/2	200	735	30
	Casting 7/3	150	740	30
AlSi12	Casting 12/0	250	700	0.1
	Casting 12/1	250	690	50
	Casting 12/2	230	700	50
	Casting 12/3	200	715	50

3. Results

3.1. Results of mechanical properties

After casting, the individual parts of the casting were machined into shape of 8×8, 6.3×10, 5×10, 4×14 and 3.15×14 mm to evaluate mechanical properties (UTS, E). To evaluate the mechanical properties, a tensile test was performed. Tensile test was carried out on the WDW 20 machine with an extensometer on the Department of Technological Engineering, University of Žilina. The test was run at ambient temperature and samples were tensile with a speed of 2 mm/min. The measured results of UTS, E for individual casting parameters and their individual areas of different thicknesses are shown in Tables 4-7.

It can be concluded from the results, that gravitationally casted samples obtained higher strength and plastic properties in the thinnest parts of the casting. This is due to the shorter solidification time of the thinner parts of the casting. When using the pressure during crystallization, the trend of increase the strength

TABLE 4

Results of the tensile strength for individual castings and wall thicknesses (AlSi7Mg0.3)

Wall thickness [mm]	Casting 7/0 [MPa]	Casting 7/1 [MPa]	Casting 7/2 [MPa]	Casting 7/3 [MPa]
3.15	158	157	195	195
4.00	198	170	191	191
5.00	185	164	193	193
6.30	200	188	200	200
8.00	196	185	205	205

TABLE 5

Results of the elongation (E) for individual castings and wall thicknesses (AlSi7Mg0.3)

Wall thickness [mm]	Casting 7/0 [%]	Casting 7/1 [%]	Casting 7/2 [%]	Casting 7/3 [%]
3.15	5.7	2.1	2.6	2.4
4.00	2.7	1.6	2.0	1.8
5.00	2.2	1.3	1.4	3.1
6.30	3.1	3.4	3.5	8.6
8.00	1.8	4.5	7.4	9.1

TABLE 6

Results of the tensile strength for individual castings and wall thicknesses (AlSi12)

Wall thickness [mm]	Casting 12/0 [MPa]	Casting 12/1 [MPa]	Casting 12/2 [MPa]	Casting 12/3 [MPa]
3.15	183	186	187	174
4.00	184	188	197	171
5.00	166	193	194	184
6.30	178	190	188	198
8.00	167	199	195	194

TABLE 7

Results of the elongation for individual castings and wall thicknesses (AlSi12)

Wall thickness [mm]	Casting 12/0 [%]	Casting 12/1 [%]	Casting 12/2 [%]	Casting 12/3 [%]
3.15	4.1	5.8	3.0	4.1
5.00	3.2	5.3	5.2	3.2
4.00	3.8	4.4	3.3	3.1
6.30	3.5	5.7	5.4	5.8
8.00	3.2	7.0	6.3	6.8

and plastic properties is the opposite. The more pronounced effect of applied pressure was manifested in the thicker sections of the cast – 6.30 and 8.00 mm.

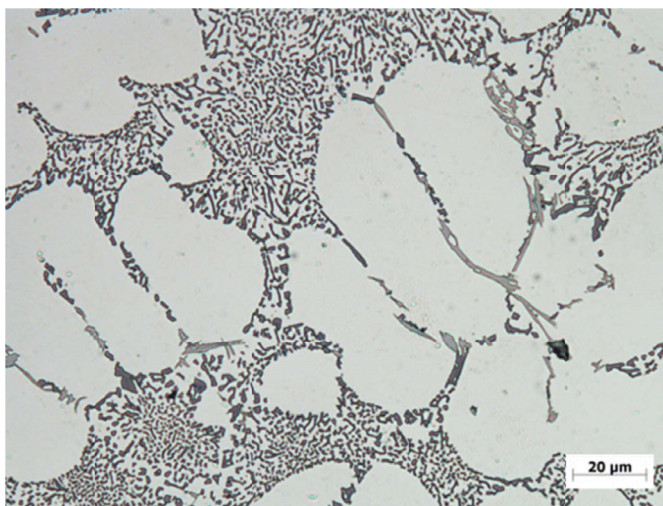

Fig. 2. Microstructure of AlSi7Mg0.3 alloy, casting 7/0, thickness 5 mm

3.2. Evaluation of the microstructure

After evaluating the mechanical characteristics, the samples were taken to evaluate the microstructure. The structure was evaluated only in samples with specific mechanical characteristics. A microstructure of gravity casted castings with a wall thickness of 5.00 mm is shown in Fig. 2 and 3.

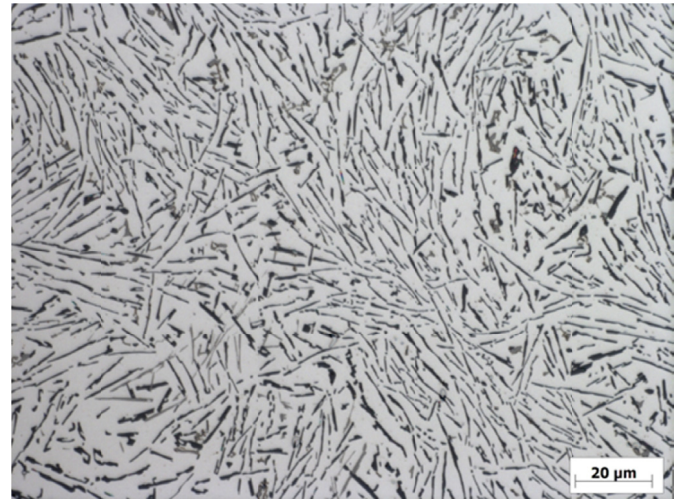

Fig. 3. Microstructure of AlSi12 alloy, casting 12/0, thickness 5 mm

In Figs 4-6 are illustrate microstructures of AlSi7Mg0.3 alloy with crystallisation under pressure.

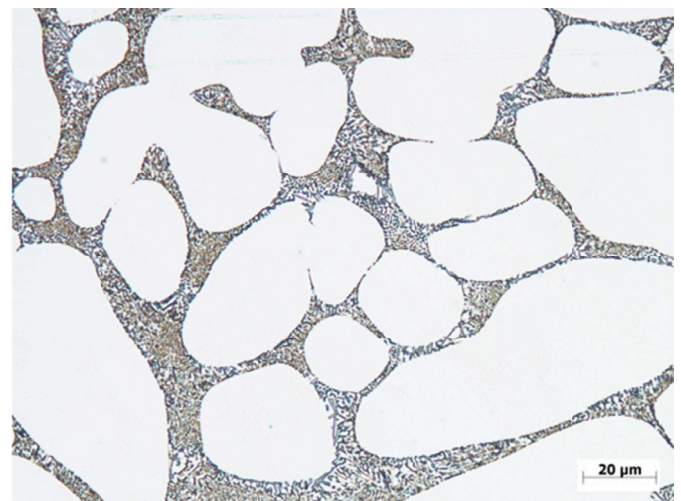

Fig. 4. Microstructure of AlSi7Mg0.3 alloy, casting 7/1, thickness 8 mm

The alloy AlSi7Mg0.3 is composed of an α -phase and a eutectic silicon, which is the excluded as rod-shaped. This structure is typical for the modified condition. There is no significant change in the size of the alpha phase by the applied pressure. In the structure, however, it is possible to observe an increased volume proportion of the alpha phase and the volume proportion of silicon in the eutectic is greater. This change in the entire cross section of the individual casting parts resulted in an increase of the mechanical and plastic properties mainly

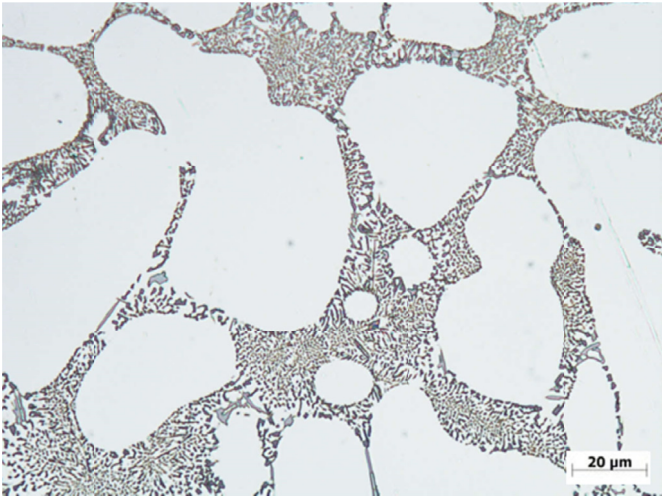

Fig. 5. Microstructure of AlSi7Mg0.3 alloy, casting 7/2, thickness 8 mm

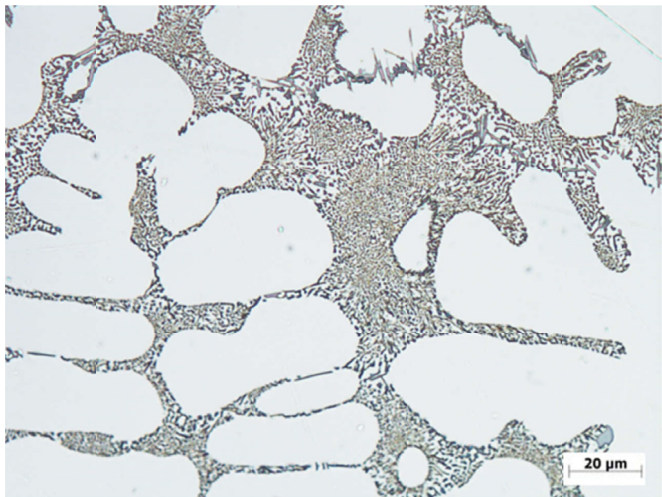

Fig. 6. Microstructure of AlSi7Mg0.3 alloy, casting 7/3, thickness 6.3 mm

in the thicker parts of the casting. The change of morphology of eutectic silicon does not occur.

In Figs 7-9 are illustrated the microstructures of the AlSi12 alloy with crystallisation under pressure.

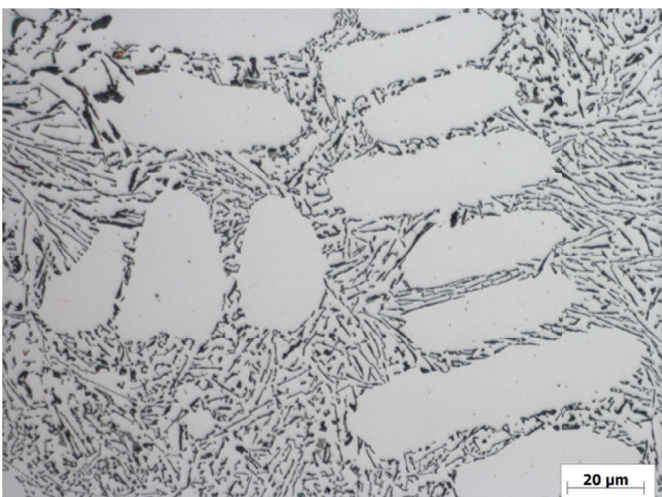

Fig. 7. Microstructure of AlSi12 alloy, casting 12/3, thickness 4 mm

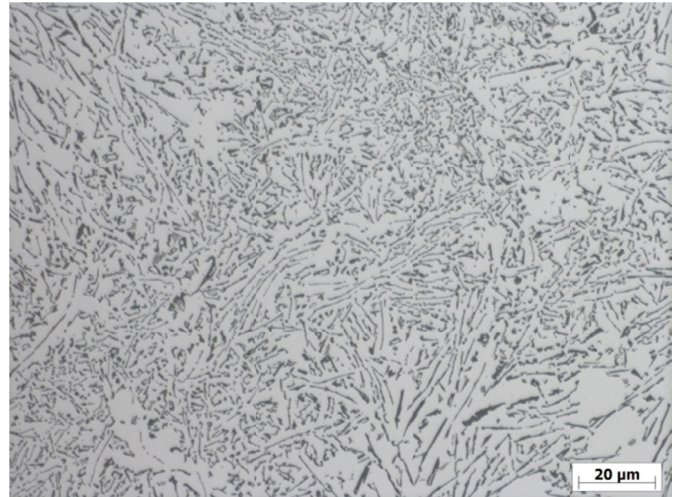

Fig. 8. Microstructure of AlSi12 alloy, casting 12/1, thickness 3.15 mm

The AlSi12 alloy is composed of an eutectic silicon, which is excluded in lamels form. In the pressure affected castings we can notice a significant shortening of lamellar eutectic silicon. At the casting temperature of 715°C the alpha phase begins to formed and the proportion of silicon in the eutectic is increased. The results show that apart from the pressure itself, the casting temperature has a more pronounced effect on the formation of the structure. The change of morphology of eutectic silicon does not occur.

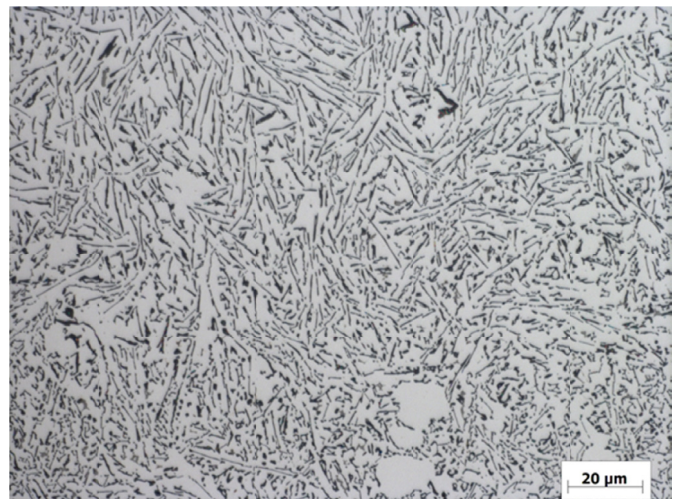

Fig. 9. Microstructure of AlSi12 alloy, casting 12/1, thickness 8 mm

3. Conclusion

By influencing of crystallisation by lower pressure, the mechanical properties and structural characteristics were favourably influenced. By observing the structure, it was found that the influence of AlSi12 alloy structure only occurred in the surface layers of the casting, which also confirmed a slight increase of the strength and plastic properties in the individual parts of the casting. Lower pressure was not sufficient to affect thicker cross sections. For the AlSi7Mg0.3 alloy was due to the wide solidi-

fication interval affected both the structure and the mechanical properties was more pronounced. The influence was observed across the entire section of the individual cast parts. There was no change in the morphology of eutectic silicon. The change was only observed in the particle size of the eutectic silicon.

Acknowledgements

This work was created in the framework of the grant project VEGA N° 1/0494/17. The authors acknowledge the grant agency for support.

REFERENCES

- [1] W. Krajewski, Arch. Metall. Mater. **44**, 51-64 (1999).
- [2] W.K. Krajewski, J. Lelito, J.S. Suchy, P. Schumacher, Arch. Metall. Mater. **54**, 335-338 (2009).
- [3] J. Lelito, P.L. Žak, A.L. Greer, J.S. Suchy, W.K. Krajewski, B. Gracz, M. Szucki, A.A. Shirzadi, Composites Part B – Engineering **43**, 3306-3309 (2012).
- [4] R. Pastircak, J. Scury, M. Bruna, D. Bolibruchova, Archives of Foundry Engineering **17** (2), 75-78 (2017).
- [5] D. Bolibruchova, J. Macko, M. Bruna, Arch. Metall. Mater. **59** (2), 717-721 (2014).
- [6] J.O. Aweda, M.B. Adeyemi, J. Mater. Process Tech. **209** (3), 1477-1483 (2009).
- [7] R. Konar, M. Mician, Archives of Foundry Engineering **17** (2), 35-38 (2017).
- [8] J. H. Lee, H. S. Kim, C. W. Won, B. Cantor, Mater. Sci. Eng. A **338** (1-2), 182-190 (2002).
- [9] D. Bolibruchova, L. Richtarech, Archives of Foundry Engineering **15** (1), 9-12 (2015).
- [10] M. Mician, R. Konar, Archives of Foundry Engineering **17** (3), 91-96 (2017).