

P. WIDOMSKI^{1*}, M. KASZUBA¹, J. KRAWCZYK¹, B. NOWAK², A. LANGE¹,
P. SOKOŁOWSKI¹, Z. GRONOSTAJSKI¹

INVESTIGATING THE POSSIBILITY OF REGENERATION BY HARDFACING FOR FORGING TOOLS BASED ON ANALYSIS OF TOOL WORKING CONDITIONS AND WEAR EVALUATION

Tests were performed on example tools applied in hot die forging processes. After withdrawal from service due to excessive wear, these tools can be regenerated for re-use through machining and hardfacing. First, analysis of worn tools was carried out for the purpose of identifying tool working conditions and wear mechanisms occurring in the surface layer of tools during forging. Testing of worn tools included observations under a microscope, surface scanning and microhardness measurement in the surface layer. The results indicate very diverse work conditions, which suggest the application of different materials and hardfacing tool regeneration technology in individual die forging processes.

Keywords: Forging tool; regeneration; hardfacing; wear

1. Introduction

In industrial forging processes, the tools used to implement forming play a special role. During forging, forming tools remain in contact with the material of the forging, exerting pressure on its surface, which deforms the material of the forging and represents the shape of the tool on the forging. Forging tools can be classified in many ways. Concurrently with [1], the author adopted a classification of tools into groups according to their purpose.

Hammer forging dies are distinguished, typically characterized by large overall dimensions as they are formed from uniform cuboid blocks, with a working impression on the top surface and so-called dovetail fixation at the base. Exchangeable die inserts can be used in hammer forging dies. Such inserts are working parts that undergo wear faster and can be replaced, while the insert's frame or housing remains in service for much longer. Similarly as in the case of press forging, die and tooling inserts are popular, fastened in frames and entire sets fixed to the table and press slider. Other forging instrumentation is also distinguished, such as punches, cutters, pushers and a broad spectrum of structural, fastening, transporting elements and elements serving other purposes, which are also indispensable for performance of forging processes. All of these tools are subject to wear processes and are characterized by a specific lifetime,

generally understood as the number of forgings or forging cycles guaranteeing a good forging [1].

The problem of lifetime particularly pertains to dies, die inserts and trimming tools as forming tools playing an active part in the process of forging and trimming the forging. These tools are first exposed to the action of destructive mechanisms that cause their accelerated wear. Analysis of the influence of destructive mechanisms on tool wear led to the formulation of a more fundamental and scientifically justified definition of lifetime. From a scientific perspective, tool life is the capacity to withstand mechanisms destroying the tool in forging processes. It is nearly synonymous with resistance to wear, which may be caused by many factors present during forging on the tool's surface and in its surface layer [2].

The defined problem of durability as the capacity to withstand mechanisms destroying forging tools is a scientific problem for research. It requires in-depth analysis of the destructive phenomena occurring in the surface layer, knowledge concerning metalworking processes and familiarity with methods of improving tool life, mainly in the fields of surface engineering. Thus, this article covers a study of forging tool destructive mechanisms with respect to selected cases.

The wear of forging tools is caused by conditions on the surface of dies, coming into contact with the forging material being deformed. The first step on the road to correct analysis of

¹ WROCLAW UNIVERSITY OF SCIENCE AND TECHNOLOGY, DEPARTMENT OF METAL FORMING, WELDING AND METROLOGY, 7-9 LUKASIEWICZA STR., 50-371, WROCLAW, POLAND
² CEO, KUŹNIA JAWOR S.A. POLAND

* Corresponding author: pawel.widomski@pwr.edu.pl



wear is therefore to identify its causes, i.e. forging tools' working conditions. The site of contact between the forging and the die is, in this aspect, extraordinarily difficult to analyze, since the forging process occurs relatively quickly under conditions of high temperature, enormous pressure and the intensive friction associated with it [3]. In addition, multiple repetition of the forging process causes cyclic changes of these conditions, and this may be intensified by the introduction of additional factors such as spraying with lubricating coolant, surface contamination with hard particles (e.g. iron oxides), different positions of the forging on die surfaces, and numerous irregularities that may occur during the forging process [4].

Among the phenomena affecting tool life, those occurring in the surface layer have the most significant impact. Considering the multitude of simultaneously occurring phenomena, it is necessary to distinguish mechanisms whose influence on wear is significant or even dominant. In the subject literature, the greatest attention is devoted to the study of five basic phenomena, being abrasive wear, adhesive wear, cracking due to thermomechanical fatigue, plastic deformation and oxidation. These and other destructive mechanisms remain in a strict relationship, mutually intensifying or canceling out one another. Usually, however, one of them is the main cause of wear, and its influence can be said to be dominant [5].

To counteract the mentioned destructive phenomena, multiple methods of extending the lifetime of forging tools are applied [6]. These methods mainly involve modification of: tool material, heat treatment, surface layer, instrumentation design, tool geometry [7], tribological conditions, etc. [8,9]. This article is dedicated to hardfacing surface treatment technology, which still remains one of the more frequently applied methods of creating layers with enhanced wear resistance. Regenerative hardfacing, which involves removal of a layer of material from the surface and coating of the surface with a new layer made of melted substrate material and weld metal, is most frequently used to regenerate worn out forging dies. The hardfaced layer is tasked with ensuring the best possible operational properties of the surface layer. This can be a preventive measure (enrichment), or in the case of regenerative hardfacing, restoration of these properties through reconstruction of the surface. Hardfacing of forging tools can be performed by various welding methods: shielded electrodes, with self-shielded powder wire, with covered arc, by the MIG (with solid wire or powder wire) or TIG method. All of these methods can be considered effective but different in terms of performance, precision of pad weld passes, possibilities of controlling and automating the process, and the possibility of applying diverse additional materials (weld metals). Since there are so many known solutions, selection of the hardfacing method requires knowledge in the field of metallurgy, materials engineering and welding [10]. Hardfacing provides nearly unlimited possibilities of admixing various alloying additives into the surface layer and makes it possible to apply layers with a complex structure or create zones with local properties and special resistance [11]. However, no single layer or hardfacing method guaranteeing the highest quality of

tools can be distinguished, but every case should be considered separately. It is only possible to distinguish certain methods on the background of others, if their effectiveness in increasing the lifetime of forging tools has been demonstrated.

In practice, hardfacing using the MAG/MIG method with solid or powder wire is most frequently used. This is a very efficient method, and there are numerous examples confirming its efficacy in enhancing the lifetime of forging tools. Hardfacing can be performed in two stages, through preliminary filling with weld metal (rebuilding), laying the bead of the intermediate buffer layer, which is subsequently surface-hardened with a layer having enhanced mechanical properties (i.e. hardfacing) [12,13]. Numerous examples of increasing tool life through hardfacing using this method are known [14], and it can be counted among the most popular and effective method among those available.

Hardfacing with a shielded electrode is a method that has been well-mastered. This method enables manual hardfacing or semi-automatic by means of simple manipulators. As early as in the mid-20th century, hardfacing "flooding" the die's impression has been widely used, by means of electrodes developed and placed on the market by Weld Mold [15]. This is a very efficient method, since the amount of weld metal applied may reach up to 45 kg/h. This method is also successfully applied for local regenerative repairs [16,17]. Its main disadvantage is difficulty in automation, and because of this, it is now increasingly being replaced by MIG and MAG methods as well as laser metal deposition.

Among welding techniques, the TIG method is noteworthy, as it provides a stable arc, a small weld pool, and no spatter. The resultant pad weld is devoid of pores, has a more uniform structure and properties. TIG hardfacing is characterized by lower efficiency, but in exchange, by better functional properties of the pad welds. The TIG method is used to improve the lifetime of forging tools through hardfacing with stellites (cobalt- or nickel-based superalloys) [18-21].

Many other applications where the lifetime of forging tools was improved through hardfacing can be cited. Selective hardfacing, involving the local introduction of material with different properties for the purpose of preventing wear in a given area, yields interesting results [22]. Hardfacing can be performed in zones [23] and in layers by building gradient and bimetallic layers [24,25]. There is a great opportunity to increase the lifetime of hardfaced forging tools by nitriding. It was presented first in paper [26], which showed its potential and it was widely discussed in other paper, which describes the positive impact of nitrides and the beneficial effect of this thermo-chemical treatment on the microstructure of hardfaced, welded material [27]. Hardfacing can be combined with nitriding, which can extend the lifetime of forging tools even three times [28].

Remelting and melting techniques are also distinguished among welding techniques, and they can be called hardfacing if the melted metal of the substrate is enriched with the weld metal. This technique is widely used to produce and regenerate tools with an enriched surface layer with enhanced wear resistance. It was demonstrated that electromagnetic melting makes it possible to create gradient layers applied to increase the lifetime

of forging tools [26]. Hardfacing through laser melting is also extraordinarily effective. In recent years, laser techniques have dominated many fields of engineering. In surface engineering, lasers are generally used as a source of rapid local heating (focused), where the thermal effects of the laser beam's action on the surface are mainly used. The continuous development of laser beam machining (LBM) arises from the many advantages of these processes. The most important among them include: high efficiency, possibility of process automation and control, cost reduction, elimination of finishing operations, better product quality, savings of materials, contactless machining, and the absence of thermal deformations [29]. In surface treatment until now, laser techniques have most commonly been used for quenching, annealing and tempering the surface [30]. Laser treatment is applied increasingly often to modify surface layers, where the process of very rapid melting and crystallization of a thin layer of material near the surface is used. These conditions make it possible to obtain microstructures of the material that vary from those obtained under equilibrium conditions, which is used for melting hardening, amorphization and concentration [31]. Laser treatment also makes it possible to create new alloy layers (alloying) in the surface layer. The base material can be melted simultaneously with another alloy or alloying element, and the materials are mixed. In this way, not only new elements but also compounds like: carbides, borides, nitrides can be introduced, creating a new structural and functional surface quality [30,32].

The latest laser techniques used in the case of forging tools include additive technologies, such as LMD (laser metal deposition), which are used for both broadly construed regeneration and for the creation of new tools [33,34]. Additive technologies employing lasers make it possible to generate complicated three-dimensional shapes, which are very difficult to execute using traditional methods [35,36]. This type of treatment has also been applied to manufacture forging tools, where the simple base part was made conventionally, while the complicated working shape was obtained by LMD technology [36,37].

The application of LMD may lead to enhanced lifetime of forging dies. Dies manufactured additively can be built of materials with properties different than that of the base material. Thanks to this, it is possible to adjust the material to the conditions present at the specific site of its application, thereby enhancing the die's overall lifetime. Additive manufacturing of dies also makes it possible to make cooling channels inside the die. This is a new functionality, which, thanks to incremental technologies such as LBM and with numerical modeling support, makes it possible to design and implement such channels for coolant flowing inside the dies or punches heated to the highest temperatures. Thus, overheating of the die can successfully be prevented despite strong thermal loads. Research conducted by IWU Fraunhofer in Germany demonstrated the positive effect of increased lifetime in punches used for hot forging [38,39].

As shown based on the literature, there are many methods of hardfacing forging tools that can be used to increase tool lifetime in forging processes. Nevertheless, to ensure the best effects, one must display knowledge of the destructive phenomena that

occur in the surface layer of tools in die forging processes when selecting hardfacing technology and selecting the weld metal. This is why this article starts with an in-depth analysis of worn forging tools, selected from among 4 groups representing the 4 main categories of tools applied in forging processes. These tools wear as typical for the given category, which will make it possible to infer the hardfacing technology dedicated for the entire tool group. The second part of the article concerns analysis and selection of materials and indicates dedicated welding techniques and parameters for hardfacing by means of these methods.

2. Materials and methods

Research was conducted in the following order:

- Selection of representative forging tools from among the 4 categories – for each category one forging process was selected in which the tool most exposed to wear was indicated.
- Analysis of tool working conditions in the 4 selected representative forging processes
- Study of tool wear phenomena for the purpose of determining causes of wear in critical areas indicated on the working surface of each tool – determination of dominant destructive phenomena accelerating wear
- Selection of additional materials for laying pad welds
- Selection of the technology and parameters of the regenerative hardfacing process
- Analysis of the microstructure, microhardness and chemical composition of obtained pad welds

Analysis of the working conditions of forging tools was conducted based on observations of critical process parameters such as temperature, pressures, friction path, etc. This data was measured by means of a rapid thermovisual FLIR T840 camera (temperature on the surface of dies) and computed by numerical modeling in FORGE software (temperature in contact with forging, pressures, friction path).

The study of destructive phenomena was carried out by means of light microscopy on an Olympus GX51 microscope (observation of microstructure in the cross-section of the surface layer, etched with nital). and by means of scanning electron microscopy – SEM (observation of cracks on the surface layer and changes visible on the surface). Similarly, microhardness measurements were carried out in the surface layer by means of a LECO AMH43 hardness tester using the Vickers method under 500 g load.

Additional materials were selected by considering, above all, the possibilities of achieving the expected parameters of the surface layer, such as hardness and cracking resistance. These materials were mainly selected from among the materials available on the market, since the authors did not have the opportunity to develop their own materials.

Regenerative hardfacing technology was selected according to the criteria of efficiency, economic feasibility and availability, so as to ensure a useful effect of application of the developed technology under industrial conditions.

Examinations of the microstructure of hardfaced samples were conducted under conditions similar to those in tool tests, however, more and different reagents were applied to etch the microstructure, including nital, Mi_3Fe and picric acid, and aqua regia. Microhardness measurements were performed on a LECOAMH43 hardness tester using the Vickers method under a load of 100 g.

3. Results and discussion

Results are presented according to the adopted methodology, described in section 2. Analysis was conducted in division into tool categories. Separate analysis was carried out for each group of tools, leading to selection of the material and hardfacing technology.

3.1. Selection of representative forging tools

In die forging processes, there is a natural division into processes performed on forging hammers and processes performed on presses, screw presses and additionally on rolling mills. This is why hammer forging dies are the first category. The second most numerous group are die inserts applied for forging on presses. This group is divided into two categories according to the degree of complexity of the working impression – inserts with an axially symmetrical structure and inserts with an irregular shape of the impression are distinguished. Axially symmetrical inserts can be hardfaced on turntables and machined on lathes, which significantly facilitates the regeneration process. Inserts

with an irregular shape require the application of a welding robot for the hardfacing process and CNC mill for the machining process before and after hardfacing. The next group are cutters, which accompany all forging processes with flash. Fig. 1 shows examples of 4 tools, representing the 4 mentioned categories of forging tools.

3.2. Analysis of working conditions and wear of hammer forging dies

The process of forging a lever was selected for analysis. The lever forging is made from C45 steel. The stock material is a cylinder with dimensions: diameter $d =$ approx. 50 mm, height $h =$ approx. 170 mm, with a weight of approx. 3 kg. After forging and trimming, the weight of the forging is about 2.5 kg. After cutting, the prepared preforings are heated in an induction heater to approx. $1180^{\circ}C$ and subjected to forging processes. Forging operations are performed on an MPM hammer with a drop hammer weight of 2 tons, and the nominal energy of the hammer's full impact is 68.65 kJ. The forging process consists of five stages, and each one is performed with several strikes of the hammer:

1. Upsetting – 1 strike;
2. Flattening in center – 2 strikes;
3. Bending – 1 strike;
4. Preliminary forging – 3 strikes;
5. Finishing forging – 2 strikes.

Die working conditions were analyzed on the selected die cavity for preliminary forging, which is subjected to 3 successive impacts in every forging cycle. These conditions (max.

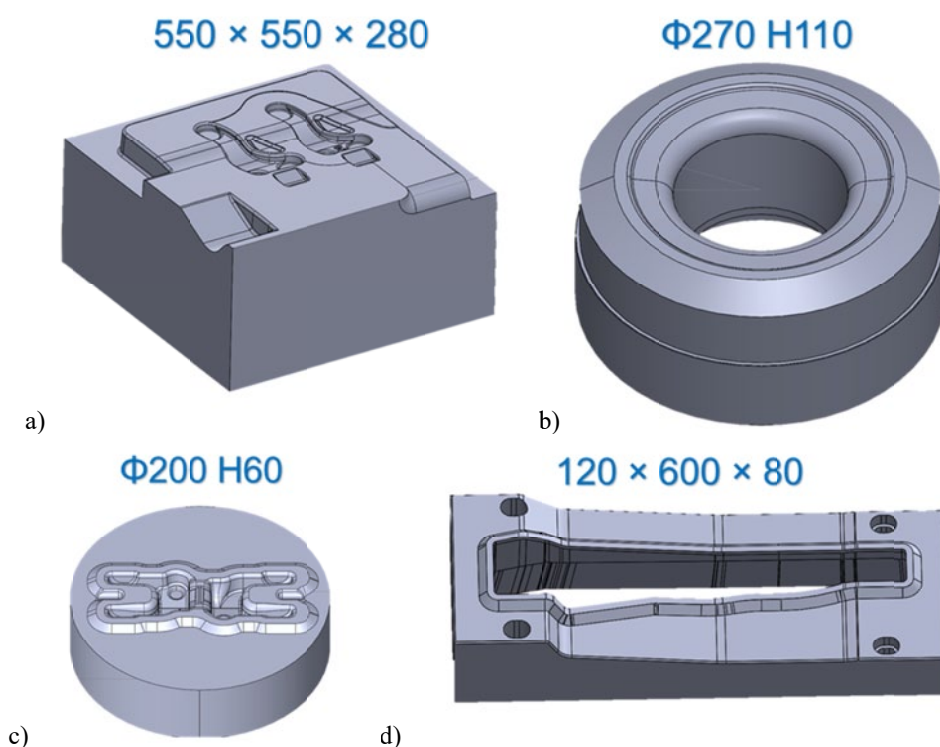

Fig. 1. Examples of forging tools: a) hammer forging die, b) axially symmetrical die insert, c) die insert with irregular cavity shape and d) trimming tool (dimensions given in millimeters)

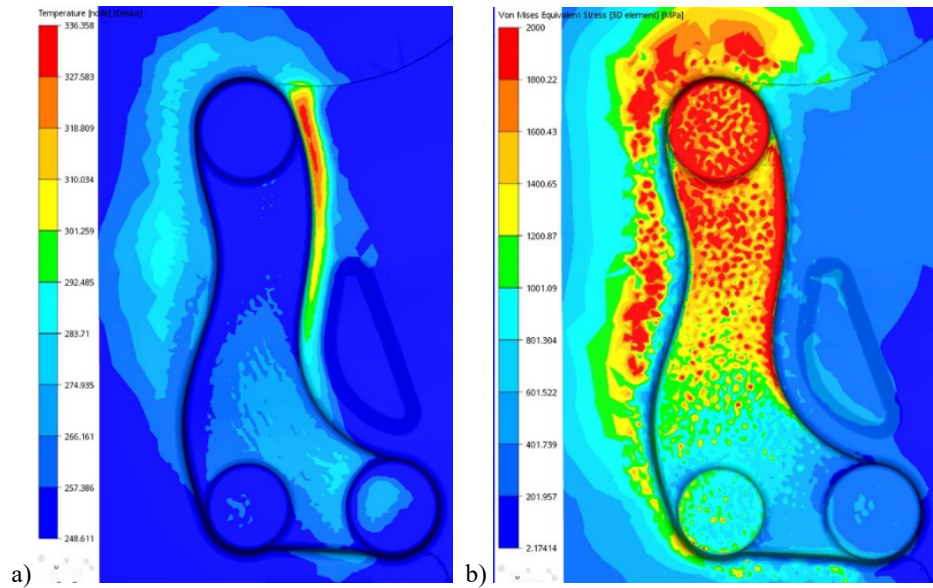

Fig. 2. Tool working conditions of the **hammer forging die** preliminary forging cavity determined by FEM: a) temperature, b) Huber-Mises reduced stress

temperature values on the surface and reduced stresses on the die surface) were determined based on the numerical model of the forging process, made in FORGE software. Fig. 2 presents selected results of this analysis.

As demonstrated, hammer forging tools work at a temperature up to 350°C and are exposed to high pressures. These conditions contribute to faster tool wear, which mainly occurs due to abrasive wear. Successive figures show the results of analysis of die wear in this process, where the die underwent 2411 forging cycles and was then withdrawn from operation. The die was made from 55NiCrMoV6 steel, which was hardened, heat-treated by hardening and double tempering in order to achieve a hardness of approx. 35-37 HRC (approx. 330-350 HV) throughout its entire volume. The tool was not subjected to surface treatment for improving its lifetime. Wear analysis was first conducted by scanning, where the scan before forging was compared to the scan after forging. This measurement made it possible to identify critical areas where the greatest wear occurred. Fig. 3a presents the results of wear analysis, and Fig. 3b indicates critical area X where wear was analyzed.

The effects of wear, i.e. cracks, abrasive furrows and oxides, were observed under a scanning electron microscope. In addition, microhardness was measured in the surface layer in order to determine whether tempering of the material occurred. The results of observations in area X are presented in Fig. 4.

The wear analysis results presented in Fig. 4 indicate the presence of abrasive wear, which causes removal of layers of the material from the die's surface. Tempering does not occur, since the temperature does not rise above 350°C, as previously demonstrated and confirmed by hardness measurement. Cyclically variable stresses cause the occurrence of cracks with a depth of approx. 200 μm, however, they are not dense and do not readily propagate into the die.

3.3. Analysis of working conditions and wear of axially symmetrical die inserts

The hub forging process was selected as the representative forging process in this category. Forging of the preforming was

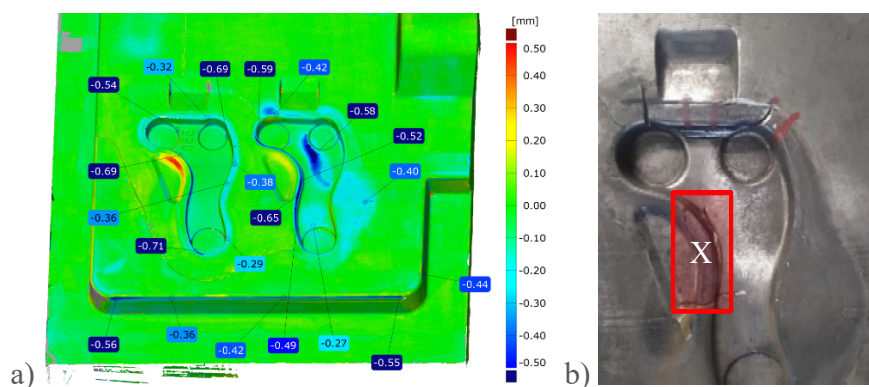

Fig. 3. Results of worn hammer forging die preliminary forging cavity surface analysis: a) comparison of scans of the tool's working surface before and after forging and b) site from which the sample was cut out for analysis

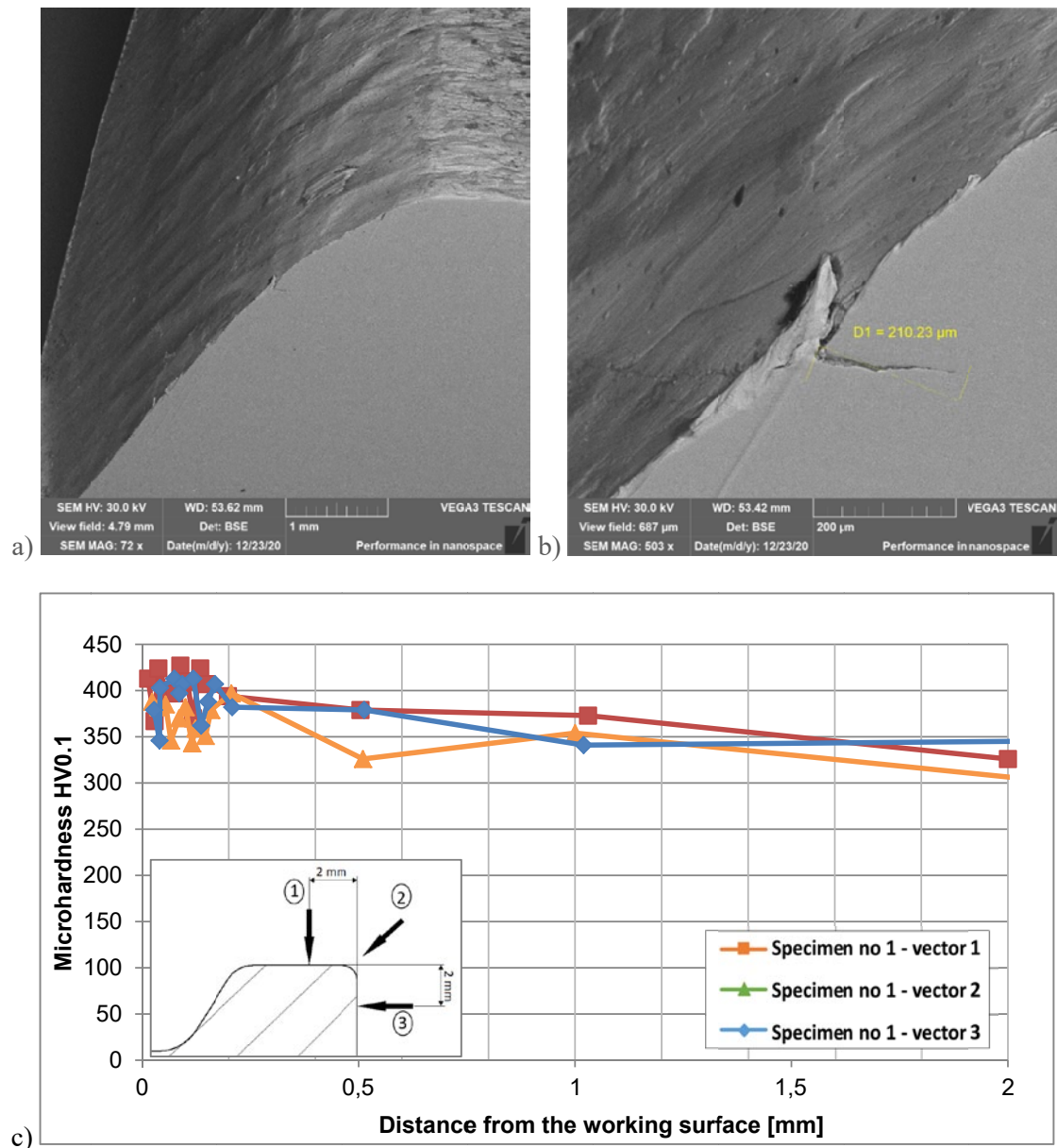

Fig. 4. Results of worn hammer forging die preliminary forging cavity analysis in cross-section: a) view of working surface in SEM, b) magnification of crack and measurement of its depth, c) results of microhardness measurement as a function of distance from the tool's working surface

performed in 3 operations on a Massey press with pressing force of 2500 tons and in a single additional operation on a P-450T press. The forging operations were: upsetting, preliminary forging and finishing forging. Additional collar eversion is performed on the P-450T press, where a special instrument is installed, performing collar eversion in two press strokes. First, the narrower end of the hub is pre-everted at an angle of about 45°, then, after transfer to the second impression, finishing eversion is performed at an angle of 90°. The initial temperature of the stock material is about 1170°C, and the material is heated in an induction heater. After forging operations and prior to eversion, the forging is heated in a gas furnace to a temperature of about 1150°C. The material of the forging is S355J2 steel. The stock material is a rod with a square cross-section: wall width 1000 mm and length about 95 mm. The net weight of the pre-forging is about 5.5 kg.

Die working conditions were analyzed on the lower forging die for preliminary forging, which is subjected to successive impacts in every forging cycle. These conditions (max. temperature values on the surface and reduced stresses on the die surface) were determined based on the numerical model of the forging process, made in FORGE software. Fig. 5 presents selected results of this analysis compared with the result of thermovision analysis.

As demonstrated, axially symmetrical forging tools work at a temperature up to 380°C and are exposed to high pressures. Thermovision examinations revealed that, in the forging process, the tool reaches an instant temperature even above 500°C. These conditions contribute to faster tool wear, which mainly occurs due to abrasive wear and tempering of the material. Successive figures show the results of analysis of die wear in this process, where the die underwent 11000 forging cycles and was then with-

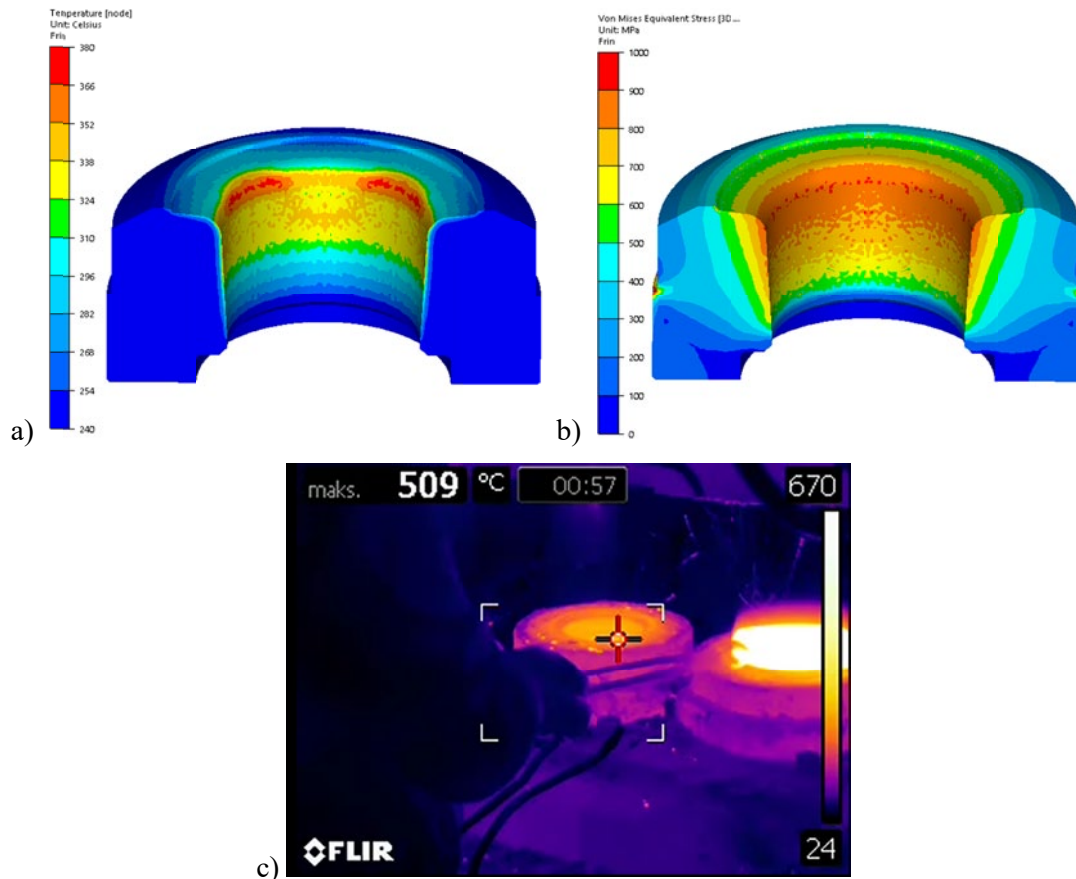

Fig. 5. Tool working conditions of the preliminary forging die insert determined by FEM: a) temperature, b) Huber-Mises reduced stress and c) max. temperature measured by thermovision

drawn from operation. The die was made from X37CrMoV5-1 steel, which was hardened, heat-treated by hardening and double tempering in order to achieve a hardness of approx. 45 HRC (approx. 450 HV) throughout its entire volume. The tool was not subjected to surface treatment for the purpose of improving its lifetime. Wear analysis was first conducted by scanning, where the scan before forging was compared to the scan after forging. This measurement made it possible to identify critical areas where the greatest wear occurred. Fig. 6a presents the results of wear analysis, and Fig. 6b indicates critical area X where wear was analyzed.

The effects of wear, i.e. cracks, abrasive furrows and oxides, were observed under a scanning electron microscope. In addition, microhardness was measured in the surface layer in order to determine whether tempering of the material occurred. The results of observations in area X are presented in Fig. 7.

The wear analysis results presented in Fig. 7 indicate the presence of abrasive wear, which causes removal of layers of the material from the die's surface. Tempering also occurs, since the temperature rises above 500°C in instants, as it was previously demonstrated in numerical modelling. Cyclically variable stresses cause the occurrence of cracks with a depth

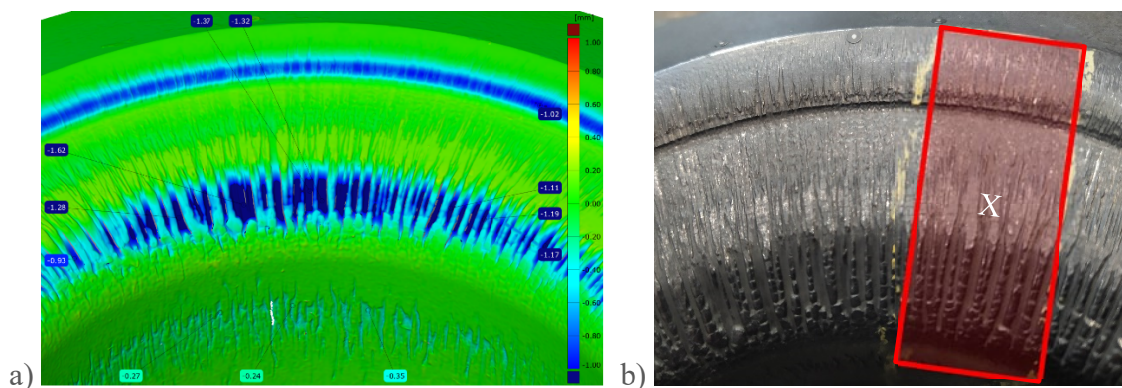

Fig. 6. Results of worn preliminary forging die insert surface analysis: a) comparison of scans of the tool's working surface before and after forging and b) site from which the sample was cut out for analysis

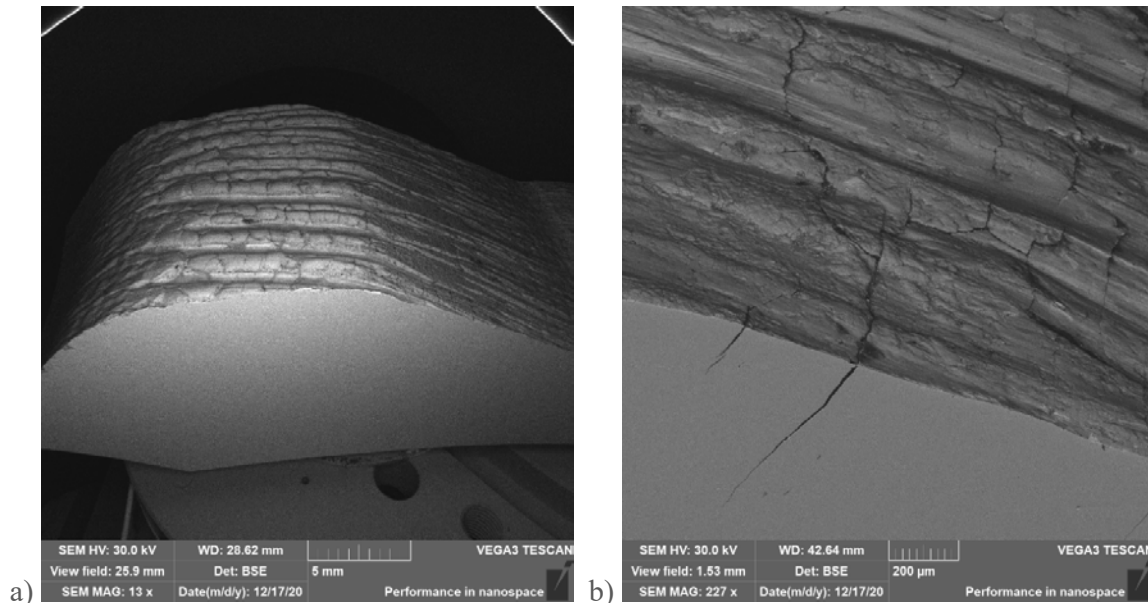

Fig. 7. Results of worn preliminary forging die insert analysis in cross-section: a) view of working surface in SEM, b) magnification of crack and detailed view of die surface

of approx. 500 μm , which are dense and readily propagate into the die. This is why the cause of wear should be accepted to be abrasive wear, which is intensified by the action of the thermo-mechanical fatigue mechanism and tempering of the material's surface layer.

3.4. Analysis of working conditions and wear of die inserts with an irregular shape of the die cavity

Tools for forging processes of forked forgings were selected for analysis from among this group of tools. The yoke forging is made from C45E steel. The stock material is a cylinder with dimensions: diameter $d =$ approx. 35 mm, height $h =$ approx. 130 mm, with a weight of approx. 0.3 kg. After the rod is cut to stock dimensions, it is heated to about 1150°C and then subjected to 3 hot forging operations:

1. Upsetting – 1 press stroke,
2. Preliminary forging – 1 press stroke,
3. Finishing forging – 1 press stroke.

This process is performed in a dual system, meaning that two details are executed simultaneously during forging. In the first operation, the part of the material intended to be the yoke is flattened, and the unflattened part of the stock will constitute the filler for the rear part of the yoke, which has a larger cross-section. Subsequent preliminary and finishing forging operations are performed in die inserts and endow the material with the shape of the ready product. Next, the forging is trimmed, i.e. the flash is separated from the useful part. The forging process is performed on a Massey 1300 T press. All tools are pre-heated to about 250°C. For this purpose, a specially developed system for induction heating of tools is applied. During forging, tools are lubricated and cooled by an aqueous graphite solution with a

concentration of 1:20. It should be emphasized that this process is performed on a robotized forging station, which has a significant impact on the tools, as it guarantees high repeatability and stable working conditions.

Die working conditions were analyzed on the lower forging die for preliminary forging, which is subjected to successive impacts in every forging cycle. These conditions (max. temperature values on the surface and reduced stresses on the die surface) were determined based on the numerical model of the forging process, made in FORGE software. Fig. 8 shows distribution of temperature and Huber-Mises reduced stress on the surface of the die's cavity.

As demonstrated, axially symmetrical forging tools work at a temperature up to 380°C and are exposed to high pressures. Thermovision examinations revealed that, in the forging process, the tool's temperature is about 300°C. These conditions contribute to rapid tool wear, which mainly occurs due to abrasive wear, and partially, tempering of the material. Successive figures show the results of analysis of die wear in this process, where the die underwent 7500 forging cycles and was then withdrawn from operation. The die was made from X40CrMoV5-1 steel, which was hardened, heat-treated by hardening and double tempering in order to achieve a hardness of approx. 50-52 HRC (approx. 500-550 HV) throughout its entire volume. The tool was not subjected to surface treatment for the purpose of improving its lifetime. Wear analysis was first conducted by scanning, where the scan before forging was compared to the scan after forging. This measurement made it possible to identify critical areas where the greatest wear occurred. Fig. 9a presents the results of wear analysis, and Fig. 9b indicates critical area X where wear was analyzed.

The effects of wear, i.e. cracks, abrasive furrows and oxides, were observed under a scanning electron microscope. In addition, microhardness was measured in the surface layer

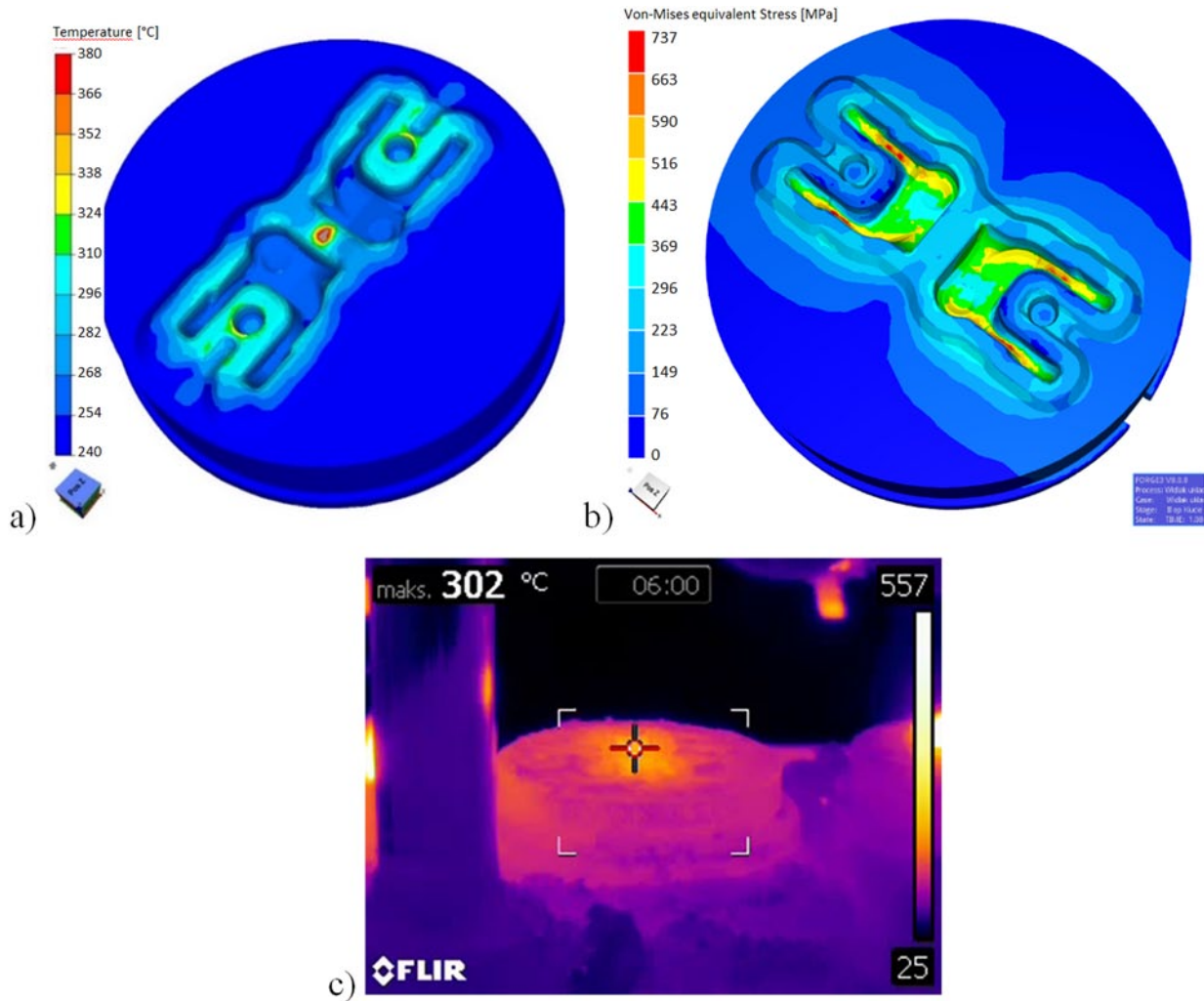

Fig. 8. Tool working conditions of the preliminary forging die insert determined by FEM: a) temperature, b) Huber-Mises reduced stress and c) max. temperature measured by thermovision

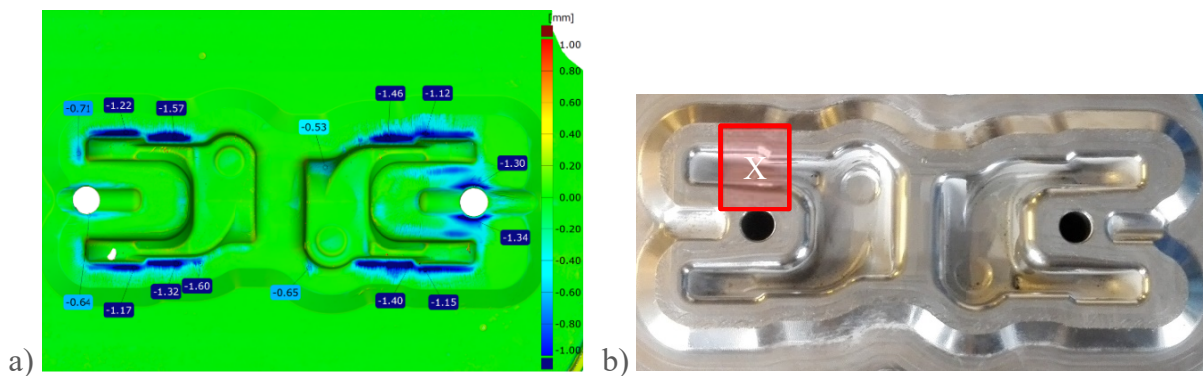

Fig. 9. Results of worn preliminary forging die insert surface analysis: a) comparison of scans of the tool’s working surface before and after forging and b) site from which the sample was cut out for analysis

in order to determine whether tempering of the material occurred. The results of observations in area X are presented in Fig. 10.

The wear analysis results presented in Fig. 10 indicate the presence of abrasive wear, which causes removal of layers of the material from the die’s surface. Tempering of the material also occurs, which may be caused by overheating in contact with the hot material of the forging and intensive friction. The

tempering effect is confirmed by the hardness measurement result (Fig. 10c). Cyclically variable stresses cause the occurrence of cracks with a depth of approx. 200-300 μm , which are dense and readily propagate into the die. This is why the cause of wear should be accepted to be abrasive wear, which is intensified by the action of the thermomechanical fatigue mechanism and tempering of the material’s surface layer.

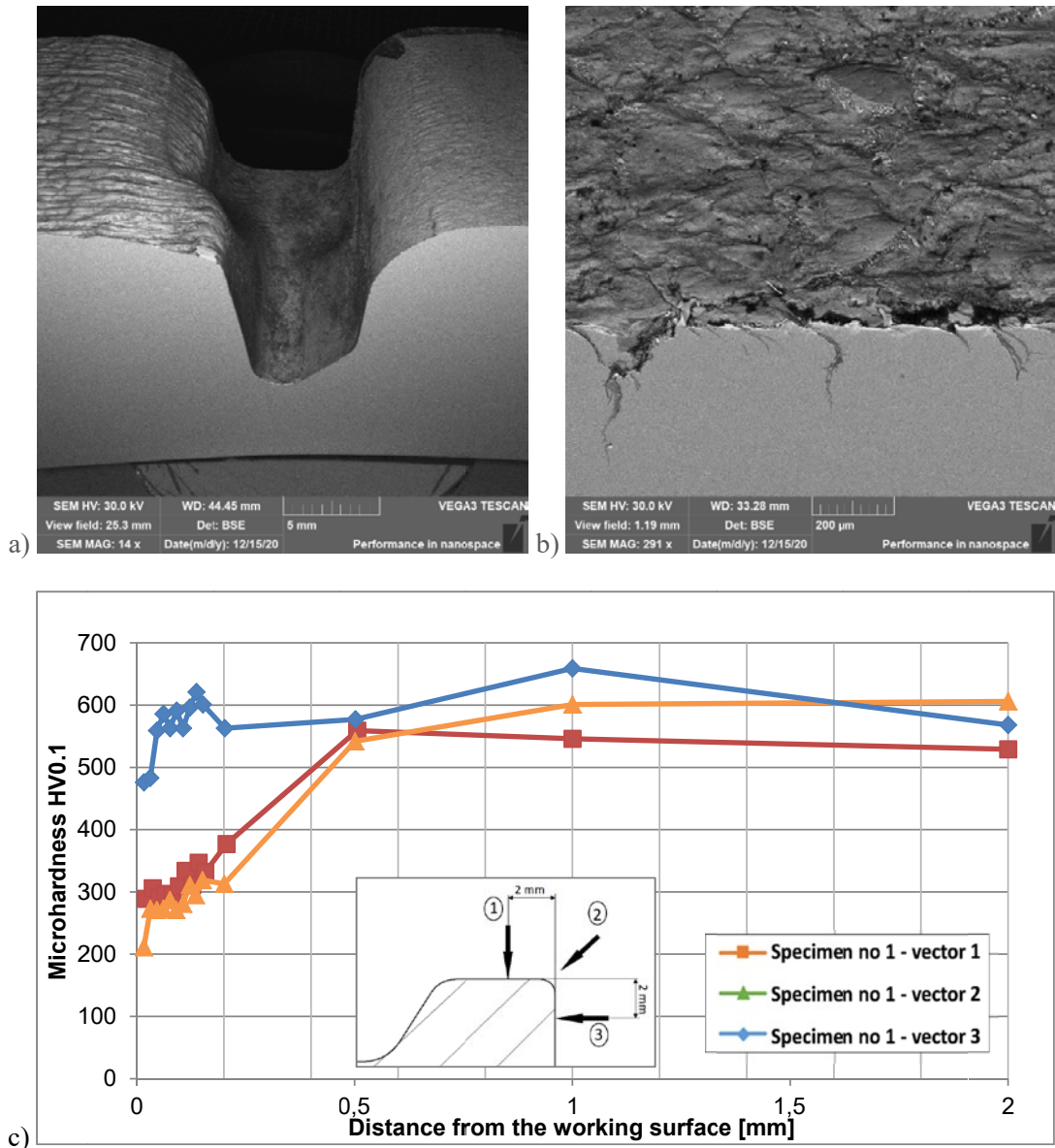

Fig. 10. Results of worn preliminary forging die insert analysis in cross-section: a) view of working surface in SEM, b) magnification of cracks and detailed view of die surface, c) results of microhardness measurement as a function of distance from the tool's working surface

3.5. Analysis of working conditions and wear of trimming tools

The fourth group of tools analyzed as part of the project is represented by the tool used to trim flash. The process of forging and trimming a lever was selected for study. The technology for manufacturing of this part has multiple stages and covers operations like: preparation of the pre-forging through rolling in two passes, preliminary forging, finishing forging, trimming and straightening. The stock material for the process is S355J2 steel in the form of a rod with a diameter of about 65 mm and length of about 350 mm. The weight of the stock is approx. 9 kg, and the weight of the ready forging is about 6.5 kg. This means that the weight of the flash is about 2.5 kg, and it is removed in a hot trimming operation on a P-350T press.

Tool conditions were analyzed on the lower trimming tool, which is subjected to longer contact in every trimming cycle.

These conditions (max. temperature values on the surface and reduced stresses on the die surface) were determined based on the numerical model of the forging process, made in FORGE software. Fig. 11 shows distribution of temperature and Huber-Mises reduced stress on the surface of the tool's trimming edge.

As demonstrated, trimming tools work at a temperature up to 260°C and are exposed to relatively lower pressures. Thermovision examinations revealed that, in the forging process, the temperature of tools is about 200°C. It should therefore be presumed that these tools will work under conditions of the strong friction that occurs when flash is trimmed from the forging. These conditions contribute to rapid tool wear, which mainly occurs due to abrasive wear, without tempering of the material. Tools are not cooled, so the thermomechanical fatigue mechanism should not occur. Successive figures show the results of analysis of tool wear in this process, where the tool underwent 3000 forging cycles and was then withdrawn from operation. The trimmer

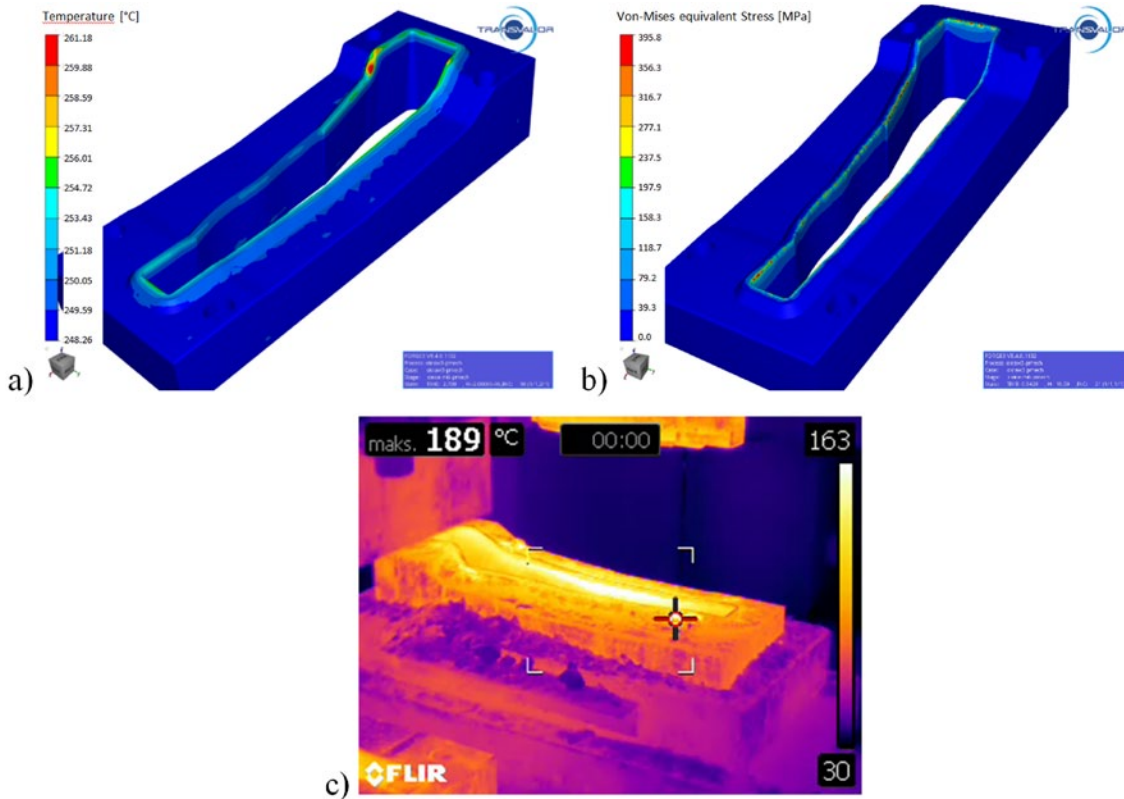

Fig. 11. Tool working conditions of the trimming tool determined by FEM: a) temperature, b) Huber-Mises reduced stress and c) max. temperature measured by thermovision

was made from X37CrMoV5-1 steel, which was hardened, heat-treated by hardening and double tempering in order to achieve a hardness of approx. 50 HRC (approx. 500 HV) throughout its entire volume. The tool was not subjected to surface treatment for the purpose of improving its lifetime. Wear analysis was first conducted by scanning, where the scan before trimming was compared to the scan after trimming. This measurement made it possible to identify critical areas where the greatest wear occurred. Fig. 12a presents the results of wear analysis, and Fig. 12b indicates critical area X where wear was analyzed.

The effects of wear, i.e. cracks, abrasive furrows and oxides, were observed under a scanning electron microscope. In addition, microhardness was measured in the surface layer in order to determine whether tempering of the material occurred. The results of observations in area X are presented in Fig. 13.

The wear analysis results presented in Fig. 13 indicate the presence of abrasive wear, which causes removal of layers of the material from the die's surface. Tempering of the material also occurs, which may be caused by overheating in contact with the hot material of the forging and intensive friction. The

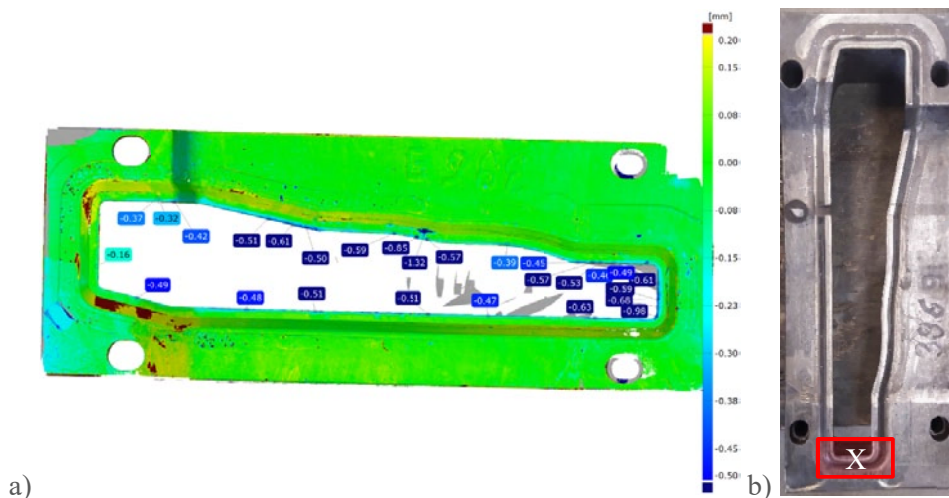

Fig. 12. Results of worn trimming tool surface analysis: a) comparison of scans of the tool's working surface before and after trimming and b) site from which the sample was cut out for analysis

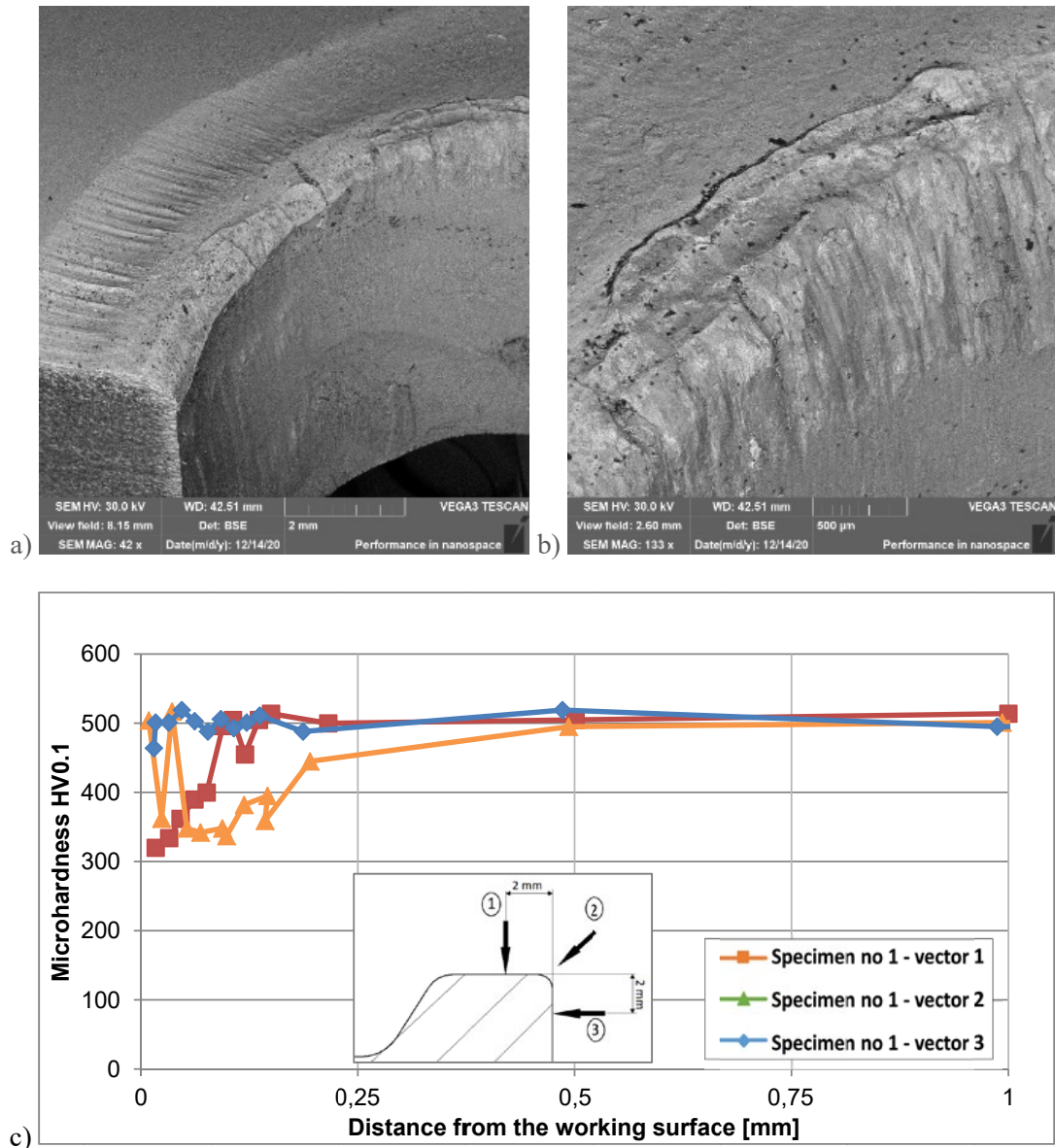

Fig. 13. Results of worn trimming tool analysis in cross-section: a) view of working surface in SEM, b) magnification of cracks and detailed view of die surface, c) results of microhardness measurement as a function of distance from the tool's working surface

tempering effect is confirmed by the hardness measurement result (Fig. 13c). Not too many cracks were observed. This is why the cause of wear should be accepted to be abrasive wear, which is intensified by tempering of the material's surface layer.

3.6. Selection of additional materials for laying pad welds

Based on the results obtained in tests of tool working conditions in the 4 selected groups and on the results of wear analysis of representative forging tools, guidelines for selection of material for hardfacing were developed. This material should meet expectations by ensuring the following properties:

- Resistance to present wear-inducing destructive factors,
- Possibility of cohesive joining with the base material,
- Sufficiently high performance of the hardfacing process.

Results of material selection are presented in tabular form in TABLE 1. Calculation of the required depth of machining was made on the basis of knowledge about tool wear in the analysed forging processes. If the tool is worn through cracks, the material must be removed to the depth of these cracks. If the material is worn down by abrasion, then at least as much as is lost over the entire surface shall be removed. If it is tempering, remove a layer of softened material.

3.7. Analysis of the microstructure, microhardness and chemical composition of obtained pad welds

The results presented in TABLE 1 have shown the potential of using materials such as Castolin DO*341 in relation to hammer forging dies, Castolin DO*360X to axially symmetrical die

Selection of additional material for the purpose of hardfacing forging tools in selected groups

Tool group	Hammer forging die	Axially symmetrical die insert	Die insert with irregular cavity shape	Trimming tool
Working temperature [°C]	200-400	400-600	300-500	150-300
Primary wear mechanism	abrasive wear	abrasive wear	abrasive wear	abrasive wear
Other wear mechanisms	Fatigue cracking	Thermomechanical fatigue, tempering	Thermomechanical fatigue, tempering	tempering
Max. wear depth [mm], g_1	0.69	1.62	1.60	0.98
Max. crack depth [mm], g_2	0.210	0.680	0.340	0
Max. depth of tempered layer [mm], g_3	0	0.4	0.5	0.25
Required depth of mechanical processing [mm] $W = 1.5 \cdot g_1 + 1.5 \cdot g_2$, when $g_2 \geq g_3$ $W = 1.5 \cdot g_1 + 1.1 \cdot g_3$, when $g_2 < g_3$	1.35	3.45	2.95	1.75
Proposed hardness range of pad weld material [HRC]	40-45	50-55	45-50	50-60
Examples of hardfacing material	Castolin DO*341	Castolin DO*360X Eureka Alloys 852 UTP A702	Castolin DO*04 Castolin DO*360X Eureka Alloys 852	Castolin DO*15

inserts, Castolin DO*04 to die inserts with irregular cavity shape and Castolin DO*15 to trimming tools. Therefore, preliminary tests on specimens were conducted for the mentioned materials. Castolin DO*341, Castolin DO*04 (Castolin DO*360X as similar to DO*04 was omitted) and Castolin DO*15 powder wires were used in these tests.

The tests included hardfacing carried out on samples with H11 tool steel as base material. For each material, 3 layers were deposited using GMAW welding technology in a fully robotic process. The base material was preheated to 400°C and after the surfacing the material was annealed for min. 2 h at the same temperature, then cooled in the furnace together with the furnace.

Subsequently, the metallographic specimens were made and the microstructure of the welds was observed. Similarly, the microhardness and approximate chemical composition of the welds were also studied. The Fig. 14 shows photographs of samples after the surfacing process.

The samples were planed on the surface and then cut transversely to the direction of surfacing. The microstructure of the surfacing layer was observed in this section. Selected results of these observations are shown in Fig. 15.

The results of the microstructure observations confirm the homogeneous structure of the deposited layers containing HAZ,

the mixed zone and 3 layers of deposited cladding. The layers are characterised by high metallurgical purity, good fusion both with the base material and between the individual welded layers. No welding imperfections such as blisters or cracks were observed.

The layer made of DO*341 is characterised by a fine-grained martensitic structure with a relatively high number of austenite separations in the interdendritic spaces.

The layer of hardfacing material obtained on DO*04 wire is characterised by high metallurgical purity, good penetration into both the base material and the individual welded layers. No welding imperfections such as blisters, non-metallic inclusions or cracks were observed. The weld deposited layer contains columnar grains, perpendicular to the fusion line, with a dendritic structure. In the top layer of the deposit, the structure consists of austenite with small amounts of chromium and molybdenum carbides and a small amount of martensite.

In the DO*15, the structure is similar to that of DO*341, but with a higher content of carbides, which has an influence on the higher secondary hardness of the deposit.

The next stage of the research was the measurement of the microhardness of the obtained welds. Fig. 16 shows the results of these tests.



Fig. 14. Photographs of samples after the surfacing process: a) DO*341, b) DO*04, c) DO*15



Fig. 15. Microstructure test results of samples made of a) DO*341, b) DO*04, c) DO*15

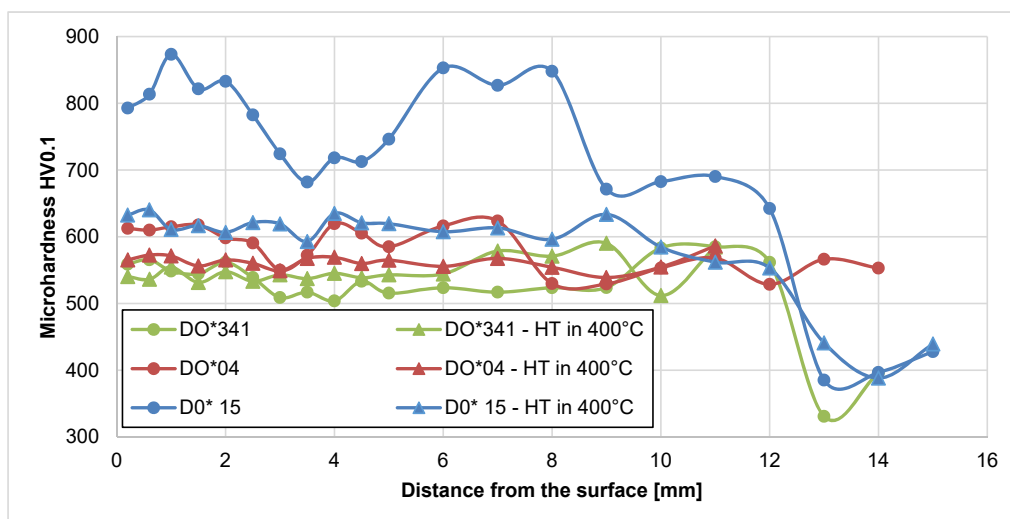

Fig. 16. Results of the microhardness test of deposited layers

4. Conclusion

The research carried out has led to the following conclusions:

- Hammer forging dies are exposed to temperatures in the range 200-400°C and are damaged by abrasive wear and fatigue cracking. It is recommended to use a material with a hardness of 40-45 HRC, e.g. Castolin DO*341, for their surfacing. The possibility of making a surfacing from this material has been confirmed.
- Axially symmetrical insert dies are exposed to temperatures in the range of 400-600°C and are damaged by abrasive wear, thermomechanical fatigue and tempering. It is recommended to use a material with a hardness of 50-55 HRC, e.g. Castolin DO*360X, Eureka Alloys 852, UTPA702 for their surfacing. The possibility of surfacing with a similar material Castolin DO*04 has been confirmed.
- Die inserts with irregular cavity shape are exposed to temperatures in the range of 300-500°C and are damaged by abrasive wear, thermomechanical fatigue and tempering. It is recommended to use hard facing material with a hardness of 45-50 HRC, e.g. Castolin DO*04, Castolin DO*360X, Eureka Alloys 852 for their surfacing. The feasibility of hard facing with Castolin DO*04 has been confirmed.
- Trimming tools are exposed to temperatures between 150-300°C and are subject to abrasive wear and tempering damage. It is recommended to use a hardness grade 50-60 HRC, e.g. Castolin DO*15 for their surfacing. The feasibility of surfacing with this material has been confirmed.
- Based on the pre-developed surfacing technology tested on samples, it will be possible to develop robotic surfacing technology for forging tools in the indicated groups mentioned in this article.

Funding

This study was funded by The National Centre for Research and Development in Poland (NCBR) by grant “Technology of accurate and high-performance regeneration of forging dies used in the die forging processes.” for Kuznia Jawor S.A.

References

- [1] P. Wasiunyk, *Kucie matrycowe / Die forging*, WNT, Warszawa, 1987.
- [2] A. Kocańda, *Określenie trwałości narzędzia w obróbce plastycznej metali / Estimation of tool life in metal forming*, in: M. Piela, A. Grosman, F. Kusiak, J. Pietrzyk (Ed.), *Inform. w Technol. Met.*, Wydawnictwo Politechniki Śląskiej, Gliwice, 2003: pp. 213-256.
- [3] J.H. Kang, I.W. Park, J.S. Jae, S.S. Kang, Study on die wear model considering thermal softening (II): Application of the suggested wear model, *J. Mater. Process. Technol.* **94**, 183-188 (1999). DOI: [https://doi.org/10.1016/S0924-0136\(99\)00104-1](https://doi.org/10.1016/S0924-0136(99)00104-1)
- [4] Z. Gronostajski, M. Kaszuba, S. Polak, M. Zwierzchowski, A. Niechajowicz, M. Hawryluk, The failure mechanisms of hot forging dies, *Mater. Sci. Eng. A.* (2016). DOI: <https://doi.org/10.1016/j.msea.2016.01.030>.
- [5] Z. Gronostajski, M. Kaszuba, M. Hawryluk, M. Zwierzchowski, A review of the degradation mechanisms of the hot forging tools, *Arch. Civ. Mech. Eng.* **14**, 528-539 (2014). DOI: <https://doi.org/10.1016/j.acme.2014.07.002>
- [6] M. Hawryluk, M. Kaszuba, Z. Gronostajski, P. Sadowski, Systems of supervision and analysis of industrial forging processes, *Eksploat. i Niezawodn. – Maint. Reliab.* **18**, 315-324 (2016). DOI: <https://doi.org/10.17531/ein.2016.3.1>
- [7] Z. Gronostajski, M. Hawryluk, M. Kaszuba, A. Niechajowicz, S. Polak, S. Walczak, D. Jabłoński, Die Profile Optimization for Forging Constant Velocity Joint Casings, *Arch. Metall. Mater.* **56** (2011). DOI: <https://doi.org/10.2478/v10172-011-0059-z>
- [8] K. Lange, L. Cser, M. Geiger, J.A.G. Kals, Tool Life and Tool Quality in Bulk Metal Forming, *CIRP Ann. – Manuf. Technol.* **41**, 667-675 (1992). DOI: [https://doi.org/10.1016/S0007-8506\(07\)63253-3](https://doi.org/10.1016/S0007-8506(07)63253-3)
- [9] Z. Gronostajski, M. Hawryluk, J. Jakubik, M. Kaszuba, G. Misiun, P. Sadowski, Solution examples of selected issues related to die forging, *Arch. Metall. Mater.* **60**, 2773-2781 (2015). DOI: <https://doi.org/10.1515/amm-2015-0446>
- [10] J.R. Turyk, *Struktura i właściwości warstw napawanych na wykończonych matrycach kuzniczych*, Politechnika Krakowska, 2019.
- [11] B. Buchmayr, *Damage, Lifetime, and Repair of Forging Dies*, BHM Berg- Und Hüttenmännische Monatshefte. (2017). DOI: <https://doi.org/10.1007/s00501-016-0566-3>
- [12] R. Miller, *Weld Repair of Tools and Dies: 10 Popular Q&As*, Postle Ind. Inc.; Cleveland, Ohio. 1-3 (2017). http://www.hardfacetechnologies.com/postle_hft_btsp/pdfs/forge-weld-repair-postle.pdf.
- [13] V. Lazić, D. Arsić, R. Nikolić, S. Aleksandrović, D. Milosavljević, M. Djordjević, R. Čukić, Repair of damaged forging dies by hard facing (HF) technology, *Prod. Eng. Arch.* (2015). DOI: <https://doi.org/10.30657/pea.2017.06.07>
- [14] V. Lazić, A. Sedmak, S. Aleksandrović, D. Milosavljević, R. Čukić, V. Grabulov, Repair of the damaged forging hammer mallet by hard facing and weld cladding, *Teh. Vjesn.* (2009).
- [15] D. Lee, *Extend Die Life with Flood Welding*, (2019). <https://www.forgemag.com/articles/84887-extend-die-life-with-flood-welding> (accessed April 12, 2020).
- [16] S. Pytel, J. Turek, S. Okoński, K. Zarębski, The properties and microstructure of padding welds built up on the surface of forging dies, *Arch. Foundry Eng.* **10**, 5-10 (2010).
- [17] C.U. Balu, P.O. Daijo, K.P.S. Faizal, T.O. Rinson, J. Salim, Sigmmon, T. Mathew, Welding life enhancement of steel forging dies, *Int. J. Adv. Eng. Glob. Technol.* **4**, 1771-1779 (2016).
- [18] M. Farhani, A. Amadeh, H. Kashani, A. Saeed-Akbari, The study of wear resistance of a hot forging die, hardfaced by a cobalt-base superalloy, in: *Mater. Forum*, 2006.

- [19] H. Kashani, A. Amadeh, H.M. Ghasemi, Room and high temperature wear behaviors of nickel and cobalt base weld overlay coatings on hot forging dies, *Wear*. (2007). DOI: <https://doi.org/10.1016/j.wear.2006.08.028>.
- [20] M. Bayramoglu, H. Polat, N. Geren, Cost and performance evaluation of different surface treated dies for hot forging process, *J. Mater. Process. Technol.* (2008). DOI: <https://doi.org/10.1016/j.jmatprotec.2007.11.256>.
- [21] H. Kashani, A. Amadeh, M.R. Vatanara, Improvement of wear resistance of hot working tool steel by hardfacing Part 2 – Case study, *Mater. Sci. Technol.* **24**, 356-360 (2008). DOI: <https://doi.org/10.1179/174328407X166731>
- [22] D.G. Ahn, H.J. Lee, J.R. Cho, D.S. Guk, Improvement of the wear resistance of hot forging dies using a locally selective deposition technology with transition layers, *CIRP Ann. – Manuf. Technol.* **65**, 257-260 (2016). DOI: <https://doi.org/10.1016/j.cirp.2016.04.013>
- [23] D.I. Kim, Y.H. Jang, H.J. Lee, D.G. Ahn, H. Song, C.S. Seok, Design of overlay coated region with hardfacing, transition and damage diminution layers for the reduction of damages of hot forging tools, *J. Mech. Sci. Technol.* **31**, 5639-5647 (2017). DOI: <https://doi.org/10.1007/s12206-017-1104-2>
- [24] F. Gao, J. Zhou, J. Zhou, L. Shen, J. Zhang, Y.P. Tao, M.Y. Li, Microstructure and properties of surfacing layers of dies manufactured by bimetal-gradient-layer surfacing technology before and after service, *Int. J. Adv. Manuf. Technol.* (2017). DOI: <https://doi.org/10.1007/s00170-016-8679-0>
- [25] L. Shen, J. Zhou, Y.B. Xiong, J.S. Zhang, Y. Meng, Analysis of service condition of large hot forging die and refabrication of die by bimetal-layer weld surfacing technology with a cobalt-based superalloy and a ferrous alloy, *J. Manuf. Process.* (2018). DOI: <https://doi.org/10.1016/j.jmapro.2018.01.005>
- [26] Z. Gronostajski, P. Widomski, M. Kaszuba, M. Zwierzchowski, M. Hawryluk, Influence of both hardfaced and nitrided layers on the durability of hot forging tools, *Surface Innovations* **6** (4-5), 301-310 (2018). DOI: <https://doi.org/10.1680/jsuin.18.00021>
- [27] M. Kaszuba, P. Widomski, P. Białucki, A. Lange, B. Boryczko, M. Walczak, Properties of new-generation hybrid layers combining hardfacing and nitriding dedicated to improvement in forging tools' durability, *Archives of Civil and Mechanical Engineering*, **20** (3), (2020). DOI: <https://doi.org/10.1007/s43452-020-00080-8>
- [28] M. Kaszuba, The application of a new, innovative, hybrid technology combining hardfacing and nitriding to increase the durability of forging tools, *Archives of Civil and Mechanical Engineering*, **20** (4), (2020). DOI: <https://doi.org/10.1007/s43452-020-00122-1>
- [29] J. Luo, X. Wang, G. Zhao, J. Wang, Study on mechanical properties and microstructure of gradient functional layer prepared by CO2 surfacing welding with electromagnetic stir, *Jinshu Xuebao/Acta Metall. Sin.* (2009).
- [30] F. Wojtkun, J. Sołncew, *Materiały specjalnego przeznaczenia, Monografie, Radom*, 1999.
- [31] J. Radziejewska, *Laserowa modyfikacja właściwości warstwy wierzchniej wspomaganą nagniataniem*, Instytut Podstawowych Problemów Techniki Polskiej Akademii Nauk, Warszawa, 2011.
- [32] J. Radziejewska, Stan warstwy wierzchniej po laserowej oraz laserowo-mechanicznej modyfikacji powierzchni, *Przegląd Spaw. – Weld. Technol. Rev.* (2016). DOI: <https://doi.org/10.26628/ps.v88i3.572>
- [33] D. Junker, O. Hentschel, M. Schmidt, M. Merklein, Investigation of Heat Treatment Strategies for Additively-Manufactured Tools of X37CrMoV5-1, *Metals (Basel)*. **8**, 854 (2018). DOI: <https://doi.org/10.3390/met8100854>
- [34] O. Hentschel, L. Siegel, C. Scheitler, F. Huber, D. Junker, A. Gorunow, M. Schmidt, Processing of AISI H11 tool steel powder modified with carbon black nanoparticles for the additive manufacturing of forging tools with tailored mechanical properties by means of laser metal deposition (LMD), *Metals (Basel)*. (2018). DOI: <https://doi.org/10.3390/met8090659>
- [35] K. Eimann, M. Drach, Instandsetzung von Werkzeugen mit Laserstrahlung, in: *Tagungsband Aachener Kolloquium Lasertechnik AKL*, 2000: pp. 29-31.
- [36] D. Junker, O. Hentschel, R. Schramme, M. Schmidt, M. Merklein, Performance of hot forging tools built by laser metal deposition of hot work tool steel X37CrMoV5-1, in: *Lasers Manuf. Conf.*, 2017.
- [37] S. Corbin, *Control of Laser Cladding Process*, in: *Laser Cladding*, CRC Press, 2004. DOI: <https://doi.org/10.1201/9781420039177.ch5>.
- [38] B. Müller, R. Hund, R. Malek, N. Gerth, Laser beam melting for tooling applications – New perspectives for resource-efficient metal forming and die casting processes, in: *IFIP Adv. Inf. Commun. Technol.*, 2013. DOI: https://doi.org/10.1007/978-3-642-41329-2_14.
- [39] B. Muller, M. Gebauer, R. Hund, R. Malek, N. Gerth, Metal Additive Manufacturing for tooling applications – Laser Beam Melting technology increases efficiency of dies and molds, in: *Met. Addit. Manuf. Conf.*, 2014.